



2	Metal Film Res Type [MFR Series]
4	Metal Film Res.-Precision Type [MFP Series]
6	Metal Film Res.-Professional Type [MF0 Series]
8	Metal Film Res.-Flame-Proof Type [FMF Series]
10	Metal Film Res.-Professional & Flame-Proof Type [FM0 Series]
12	Metal Film Res.-Power Flame-Proof Type [FMP Series]
14	Metal Oxide Film Res.-Flame-Proof Type [RSF Series]
16	Metal film Res.-Fusible Type [FRM Series]
18	Matal Film Low Value Type [MFL Series]
20	Melf Metal Film Res Type [MMF Series]
22	Melf Metal Film Power Type [MMP Series]
24	Carbon Film Res Type [CFR Series]
26	Carbon Film Res.-Professional Type [CF0 Series]
28	Carbon Film Res.-Flame-Proof Type [FCR Series]
30	Carbon Film Res.-Professional & Flame-Proof Type [FC0 Series]
32	Carbon Film Res.-Non Inductive Type [NCR Series]
34	Melf Carbon Film Res Type [MCF Series]
36	Melf Carbon Film Power Type [MCP Series]
38	Zerohm Res Type [ZOR Series]
39	Jumper Wires Type [JPW Series]
40	Wirewound Res Type [KNP Series]
42	Wirewound Res.-Non Inductive Type [NKN Series]
44	Cement Res.-Axial Lead Type [SQP/NSP Series]
46	Cement Res.-Vertical Lead Type [SQM/NSM Series]
48	Cement Res.-Radial Terminals Type [SQZ/NSZ Series]
50	Cement Res.-Clamp Mounting Type [SQH/NSH Series]
52	High Voltage Res.Type [HVR Series]
54	Packing Methods
55	Special Type [Forming Dimension]
58	Explanations of Ordering Code & P/N for System Input

Metal Film Resistors

MFR Type

Normal & Miniature Style [MFR Series]



INTRODUCTION

The MFR Series Metal Film Resistors are manufactured using vacuum sputtering system to deposit multiple layers of mixed metals and passivative materials onto a carefully treated high grade ceramic substrate, the resistors are coated with layers of blue lacquer.

FEATURES

Power Rating	1/6W, 1/4W, 1/2W, 1W, 2W
Resistance Tolerance	±0.1%, ±0.25%, ±0.5%, ±1%
T.C.R.	±15ppm/°C, ±25ppm/°C, ±50ppm/°C, ±100ppm/°C

DERATING CURVE

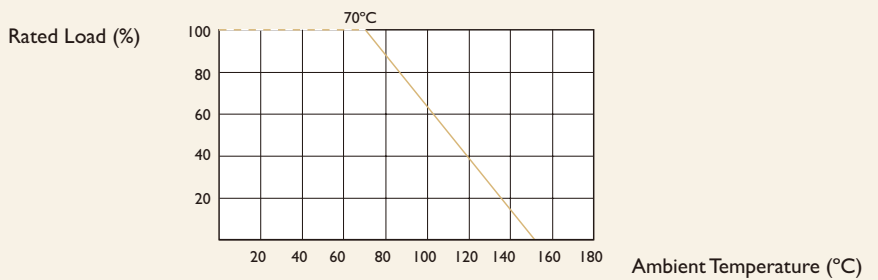

HOT-SPOT TEMPERATURE

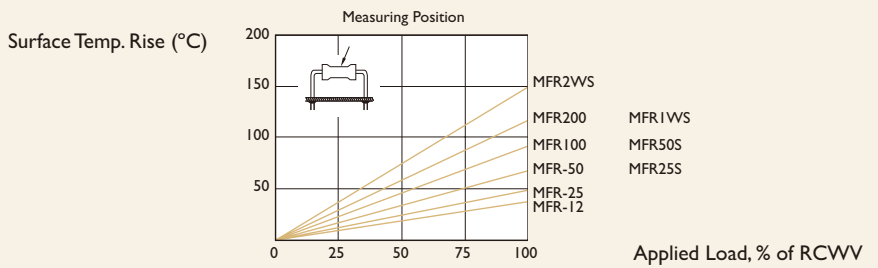

DIMENSIONS



STYLE		DIMENSION				Unit : mm
Normal	Miniature	L	øD	H	ød	
MFR-12	MFR25S	3.4±0.3	1.9±0.2	28±2.0	0.5±0.05	
MFR-25	MFR50S	6.3±0.5	2.4±0.2	28±2.0	0.6±0.05	
MFR-50	MFR1WS	9.0±0.5	3.3±0.3	26±2.0	0.6±0.05	
MFR100	MFR2WS	11.5±1.0	4.5±0.5	35±2.0	0.8±0.05	
MFR200	-	15.5±1.0	5.0±0.5	33±2.0	0.8±0.05	



Note :

ELECTRICAL CHARACTERISTICS

STYLE	MFR-12	MFR25S	MFR-25	MFR50S	MFR-50	MFR1WS	MFR100	MFR2WS	MFR200
Power Rating at 70°C	1/6W	1/4W		1/2W		1W		2W	
Operating Temp. Range	-55°C to +15°C								
Maximum Working Voltage	200V	200V	250V	300V	350V	400V	500V	500V	500V
Maximum Overload Voltage	400V	400V	500V	600V	700V	800V	1000V	1000V	1000V
Dielectric Withstanding Voltage	300V	400V	500V	500V	500V	700V	1000V	1000V	1000V
Value Range ±0.5%, ±1%	10Ω~1MΩ								
Value Rang ±0.1%, ±0.25%	100Ω~100KΩ								
Temperature Coefficient (by Type)	±15ppm/°C, ±25ppm/°C, ±50ppm/°C, ±100ppm/°C								

* Resistance range for standard resistance, below or over this resistance on request.

ENVIRONMENTAL CHARACTERISTICS

PERFORMANCE TEST	TEST METHOD	APPRAISE
Short Time Overload	JIS-C-5202 5.5	2.5 Times RCWV for 5 Seconds ±(0.25%+0.05Ω)
Dielectric Withstanding Voltage	JIS-C-5202 5.7	in V-Block for 60 Seconds by Type
Temperature Coefficient of Resistance	JIS-C-5202 5.2	-55°C to +155°C by Type
Insulation Resistance	JIS-C-5202 5.6	in V-Block >10000MΩ
Solderability	JIS-C-5202 6.5	235±5°C for 5±0.5 Seconds 95% Min. Coverage
Resistance to Solvent	JIS-C-5202 6.9	IPA for 1 Min. with Ultrasonic No Deterioration of Coatings and Markings
Terminal Strength	Direct load for 10 Sec. in The Direction of The Terminal Leads ±2.5kg (24.5N)	
Pulse Overload	JIS-C-5202 5.8	4 Times RCWV 10000 Cycles (1 Sec. on , 25 Sec. off) ±(1%+0.05Ω)
Load Life in Humidity	JIS-C-5202 7.9	40±2°C, 90~95% RH at RCWV for 1000 Hrs. (1.5 Hrs. on , 0.5 Hrs. off) ±(1.5%+0.05Ω)
Load Life	JIS-C-5202 7.10	70°C at RCWV for 1000 Hrs. (1.5 Hrs. on , 0.5 Hrs. off) ±(1.5%+0.05Ω)
Temperature Cycling	JIS-C-5202 7.4	-55°C→Room Temp.→+155°C→Room Temp. for 5 Cycles ±(0.75%+0.05Ω)
Resistance to Soldering Heat	JIS-C-5202 6.4	350°C±10°C for 3±0.5 Seconds ±(0.25%+0.05Ω)

* Rated Continuous Working Voltage (RCWV)= $\sqrt{\text{Power Rating} \times \text{Resistance Value}}$

Metal Film Resistors

PRECISION Type

Normal & Miniature Style [MFP Series]



FEATURES

Power Rating : 1/6W, 1/4W, 0.4W, 1/2W, 0.6W

Resistance Tolerance : $\pm 0.1\%$, $\pm 0.25\%$

T.C.R. : $\pm 15\text{ppm}/^\circ\text{C}$, $\pm 25\text{ppm}/^\circ\text{C}$

High thermal conductivity and specific gravity rods

Epoxy coating

Blue body color

POWER DERATING CURVE

For resistors operated in ambient temperatures above 70°C , power rating must be derated in accordance with the curve below.

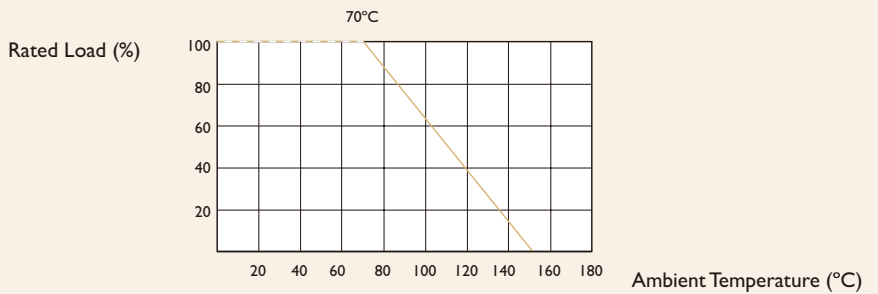

DIMENSIONS

Unit : mm

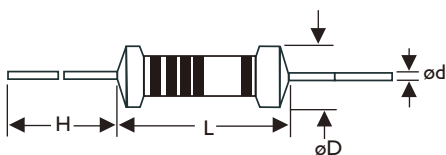

STYLE		DIMENSION			
Normal	Miniature	L	øD	H	ød
MFP-12	MFP25S	3.4±0.3	1.9±0.2	28±2.0	0.5±0.05
MFP204	—	3.4±0.3	1.9±0.2	28±2.0	0.5±0.05
MFP-25	MFP50S	6.3±0.5	2.4±0.2	28±2.0	0.6±0.05
MFP207	—	6.3±0.5	2.4±0.2	28±2.0	0.6±0.05



Note :

ELECTRICAL CHARACTERISTICS

STYLE	TEST METHOD	MFP-12	MFP25S	MFP204	MFP-25	MFP50S	MFP207
Power Rating at 70°C		1/6W	1/4W	0.4W	1/4W	1/2W	0.6W
Maximum Working Voltage		150V	200V	200V	250V	250V	250V
Maximum Overload Voltage		300V	400V	400V	500V	600V	600V
Dielectric Withstanding Voltage	JIS-C-5202 5.7 in V-Block for 60 Seconds	300V	300V	300V	500V	500V	500V
Temperature Coefficient	JIS-C-5202 5.2 Room Temp. Add 100°C	±15ppm/°C, ±25ppm/°C					
Short Time Overload	JIS-C-5202 5.5 2.5 Times RCWV for 5 Sec.	±0.1%+0.05Ω					
Insulation Resistance	JIS-C-5202 5.6 in V-Block	>10,000MΩ					
Pulse Overload	JIS-C-5202 5.8 4 Times RCWV 10,000 Cycles (1 Sec. on , 25 Sec. off)	±1.0%+0.05Ω					
Operating Temp. Range		-55°C to + 155°C					
Value Rang ±0.1%		100Ω~100K			100Ω~200KΩ		
Value Range ±0.25%		50Ω~200K			50Ω~301KΩ		

* Resistance range for standard resistance, below or over this resistance on request.

ENVIRONMENTAL CHARACTERISTICS

PERFORMANCE TEST	TEST METHOD	APPRAISE
Terminal Strength	JIS-C-5202 6.1 Direct load for 10 Sec. in the Direction of the Terminal Leads	≥2.5kg (24.5N)
Resistance to Soldering Heat	JIS-C-5202 6.4 350°C ± 10°C for 3 ± 0.5 Seconds	±0.20%+0.05Ω
Solderability	JIS-C-5202 6.5 235°C ± 5°C for 5 ± 0.5 Seconds	95% Min. Coverage
Resistance to Solvent	JIS-C-5202 6.9 IPA for 1 Min. with Ultrasonic	No Deterioration of Coatings and Markings
Temperature Cycling	JIS-C-5202 7.4 -55°C → Room Temp. → +155°C → Room Temp. for 5 Cycles	±0.25%+0.05Ω
Humidity	JIS-C-5202 7.5 40±2°C, 90~95% RH for 1,000 Hrs.	±0.50%+0.05Ω
Load Life in Humidity	JIS-C-5202 7.9 40±2°C, 90~95% RH at RCWV for 1,000 Hrs. (1.5 Hrs. on , 0.5 Hrs. off)	±1.0%+0.05Ω
Load Life	JIS-C-5202 7.10 70°C at RCWV for 1,000 Hrs. (1.5 Hrs. on, 0.5 Hrs. off)	±1.0%+0.05Ω

* Rated Continuous Working Voltage (RCWV)= $\sqrt{\text{Power Rating} \times \text{Resistance Value}}$

Metal Film Resistors

PROFESSIONAL Type Miniature Style [MF0 Series]

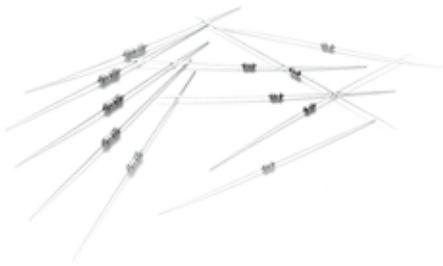

INTRODUCTION

The MF0 Series are manufactured by high vacuum sputtering deposit Metal Film on high thermal conductivity and specific gravity ROSENTHAL ceramic or same grade rods. The resistors are coated with multilayers of blue color lacquer.

FEATURES

DIN	44061, 45921 part 107
CECC	40101-039, 40101-017
MIL	10509F (Char. D & C)
Resistance Tolerance	±1%
T.C.R.	±50ppm/°C

DERATING CURVE

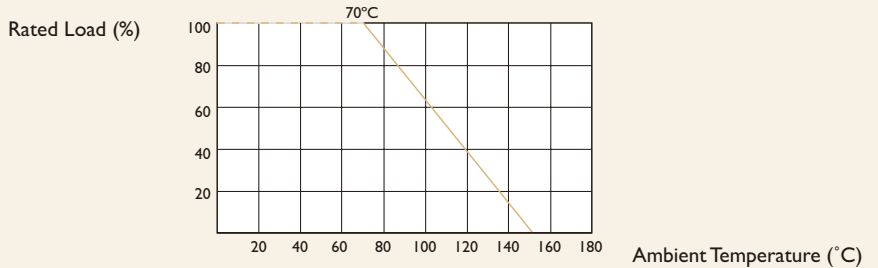

HOT-SPOT TEMPERATURE

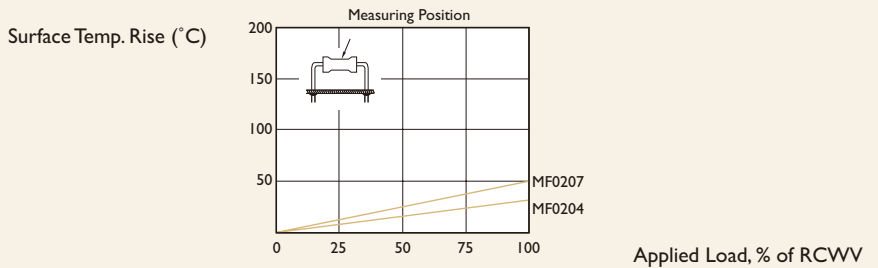

DIMENSIONS

Unit : mm

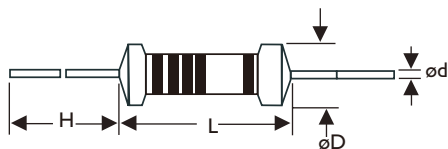

STYLE	L	øD	H	ød
MF0204	3.4±0.3	1.9±0.2	28±2.0	0.5±0.05
MF0207	6.3±0.5	2.4±0.2	28±2.0	0.6±0.05



Note :

ELECTRICAL CHARACTERISTICS

STYLE	MF0204	MF0207
Power Rating at 70°C	0.4W	0.6W
Operating Temp. Range	-55°C to +155°C	
Maximum Working Voltage	200V	300V
Maximum Overload Voltage	400V	600V
Dielectric Withstanding Voltage	300V	500V
Value Range ±1%	10Ω~1MΩ	
Temperature Coefficient	±50ppm/°C	

* Standard resistance is 10Ω~1MΩ, below or over this resistance on request.

ENVIRONMENTAL CHARACTERISTICS

PERFORMANCE TEST	TEST METHOD		APPRAISE
Short Time Overload	JIS-C-5202 5.5	2.5 Times RCWV for 5 Seconds	±(0.25%+0.05Ω)
Dielectric Withstanding Voltage	JIS-C-5202 5.7	in V-Block for 60 Seconds	by Type
Temperature Coefficient of Resistance	JIS-C-5202 5.2	-55°C to +155°C	±50ppm/°C
Insulation Resistance	JIS-C-5202 5.6	in V-Block	>10000MΩ
Solderability	JIS-C-5202 6.5	235±5°C for 5±0.5 Seconds	95% Min. Coverage
Resistance to Solvent	JIS-C-5202 6.9	IPA for 1 Min. with Ultrasonic	No Deterioration of Coatings and Markings
Terminal Strength	Direct Load for 10 Sec. in The Direction of The Terminal Leads		≥2.5kg (24.5N)
Pulse Overload	JIS-C-5202 5.8	4 Times RCWV 10000 Cycles (1 Sec. on , 25 Sec. off)	±(1%+0.05Ω)
Load Life in Humidity	JIS-C-5202 7.9	40±2°C, 90~95% RH at RCWV for 1000 Hrs. (1.5 Hrs. on , 0.5 Hrs. off)	±(1.5%+0.05Ω)
Load Life	JIS-C-5202 7.10	70°C at RCWV for 1000 Hrs. (1.5 Hrs. on , 0.5 Hrs. off)	±(1.5%+0.05Ω)
Temperature Cycling	JIS-C-5202 7.4	-55°C→Room Temp.→+155°C→Room Temp. for 5 Cycles	±(0.75%+0.05Ω)
Resistance to Soldering Heat	JIS-C-5202 6.4	350°C±10°C for 3±0.5 Seconds	±(0.25%+0.05Ω)

* Rated Continuous Working Voltage (RCWV)= $\sqrt{\text{Power Rating} \times \text{Resistance Value}}$

Metal Film Resistors

FLAME-PROOF Type

Normal & Miniature Style [FMF Series]



INTRODUCTION

The FMF series flame-proof type Metal Film Resistors are manufactured by vacuum deposit Metal Film on high thermal conductivity ceramic rods, and are coated with layers of gray color flame-proof lacquer.

These FMF flame-proof Metal Film Resistors is designed to replace the Metal Oxide Resistors and low power wire wound resistors, where when flame-proof and small size is needed.

FEATURES

Power Rating	1/4W, 1/2W, 1W, 2W
FlameProof Silicone Coating	UL94V-0
Resistance Tolerance	±1%
T.C.R.	±50ppm/°C, ±100ppm/°C

DERATING CURVE

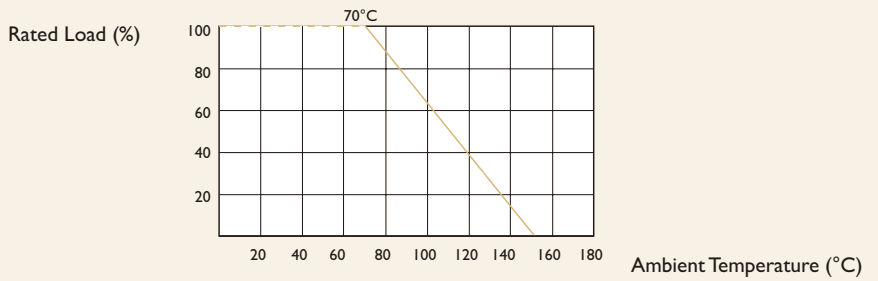

HOT-SPOT TEMPERATURE

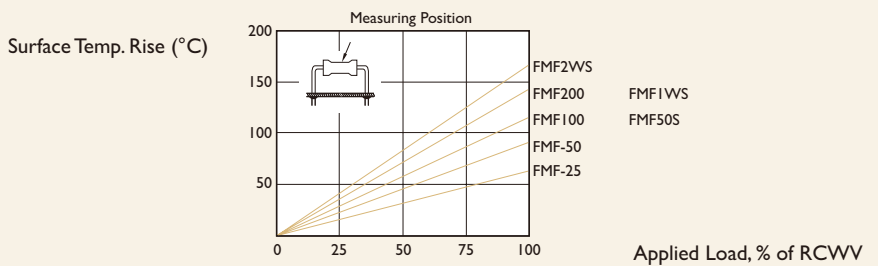

DIMENSIONS

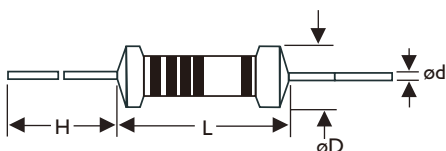

Unit : mm

STYLE		DIMENSION			
Normal	Miniature	L	øD	H	ød
FMF-25	FMF50S	6.3±0.5	2.4±0.2	28±2.0	0.6±0.05
FMF-50	FMF1WS	9.0±0.5	3.3±0.3	26±2.0	0.6±0.05
FMF100	FMF2WS	11.5±1.0	4.5±0.5	35±2.0	0.8±0.05
FMF200	-	15.5±1.0	5.0±0.5	33±2.0	0.8±0.05



Note :

ELECTRICAL CHARACTERISTICS

STYLE	FMF-25	FMF50S	FMF-50	FMF1WS	FMF100	FMF2WS	FMF200
Power Rating at 70°C	1/4W	1/2W		1W		2W	
Operating Temp. Range	-55°C to +155°C						
Maximum Working Voltage	250V	300V	350V	400V	500V	500V	500V
Maximum Overload Voltage	500V	600V	700V	800V	1000V	1000V	1000V
Dielectric Withstanding Voltage	400V	400V	500V	600V	750V	750V	750V
Value Range ±1%	10Ω~1MΩ						
Temperature Coefficient (by Type)	±50ppm/°C, ±100ppm/°C						

* Standard resistance is 10Ω~1MΩ, below or over this resistance on request.

ENVIRONMENTAL CHARACTERISTICS

PERFORMANCE TEST	TEST METHOD	APPRAISE
Short Time Overload	JIS-C-5202 5.5	2.5 Times RCWV for 5 Seconds ±(0.25%+0.05Ω)
Dielectric Withstanding Voltage	JIS-C-5202 5.7	in V-Block for 60 Seconds by Type
Temperature Coefficient of Resistance	JIS-C-5202 5.2	-55°C to +155°C by Type
Insulation Resistance	JIS-C-5202 5.6	in V-Block >1000MΩ
Solderability	JIS-C-5202 6.5	235±5°C for 5±0.5 Seconds 95% Min. Coverage
Resistance to Solvent	JIS-C-5202 6.9	IPA for 1 Min. with Ultrasonic No Deterioration of Coatings and Markings
Terminal Strength	Direct Load for 10 Sec. in The Direction of The Terminal Leads ≥2.5kg (24.5N)	
Pulse Overload	JIS-C-5202 5.8	4 Times RCWV 10000 Cycles (1 Sec. on , 25 Sec. off) ±(1%+0.05Ω)
Load Life in Humidity	JIS-C-5202 7.9	40±2°C, 90~95% RH at RCWV for 1000 Hrs. (1.5 Hrs. on , 0.5 Hrs. off) ±(1.5%+0.05Ω)
Load Life	JIS-C-5202 7.10	70°C at RCWV for 1000 Hrs. (1.5 Hrs. on , 0.5 Hrs. off) ±(1.5%+0.05Ω)
Temperature Cycling	JIS-C-5202 7.4	-55°C→Room Temp.→+155°C→Room Temp. for 5 Cycles ±(0.75%+0.05Ω)
Resistance to Soldering Heat	JIS-C-5202 6.4	350°C±10°C for 3±0.5 Seconds ±(0.25%+0.05Ω)

* Rated Continuous Working Voltage (RCWV)= $\sqrt{\text{Power Rating} \times \text{Resistance Value}}$

Metal Film Resistors

PROFESSIONAL & FLAME-PROOF Type

Miniature Style [FM0 Series]



INTRODUCTION

The FM0 Series are manufactured by high vacuum sputtering deposit Metal Film on high thermal conductivity and specific gravity ROSENTHAL ceramic or same grade rods. The FM0207 are coated with multilayers of light-green color flame-proof lacquer.

The FM0207 meets severe overload test in accordance with UL specification # 1412 without fire hazard.

FEATURES

DIN	44061, 45921 part 107
CECC	40101-039, 40101-017
Flameproof Silicone Coating	UL94V-0
Resistance Tolerance	±1%
T.C.R.	±50ppm/°C

DERATING CURVE

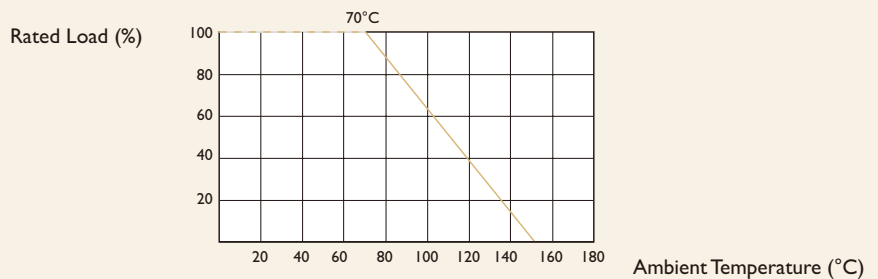

HOT-SPOT TEMPERATURE

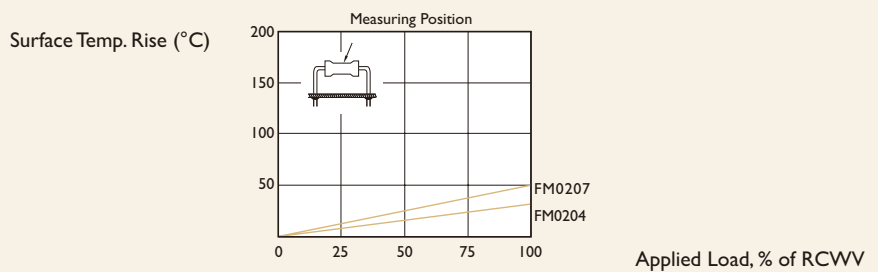

DIMENSIONS

Unit : mm

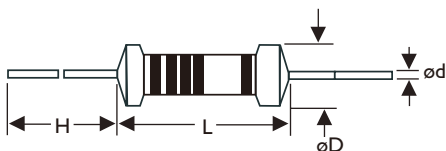

STYLE	L	øD	H	ød
FM0204	3.4±0.3	1.9±0.2	28±2.0	0.5±0.05
FM0207	6.3±0.5	2.4±0.2	28±2.0	0.6±0.05

Note :

ELECTRICAL CHARACTERISTICS

STYLE	FM0204	FM0207
Power Rating at 70°C	0.4W	0.6W
Operating Temp. Range	-55°C to +155°C	
Maximum Working Voltage	200V	300V
Maximum Overload Voltage	400V	600V
Dielectric Withstanding Voltage	300V	500V
Value Range ±1%	10Ω~1MΩ	
Temperature Coefficient	±50ppm/°C	

* Standard resistance is 10Ω~1MΩ, below or over this resistance on request.

ENVIRONMENTAL CHARACTERISTICS

PERFORMANCE TEST	TEST METHOD		APPRAISE
Short Time Overload	JIS-C-5202 5.5	2.5 Times RCWV for 5 Seconds	±(0.25%+0.05Ω)
Dielectric Withstanding Voltage	JIS-C-5202 5.7	in V-Block for 60 Seconds	by Type
Temperature Coefficient of Resistance	JIS-C-5202 5.2	-55°C to +155°C	±50ppm/°C
Insulation Resistance	JIS-C-5202 5.6	in V-Block	>1000MΩ
Solderability	JIS-C-5202 6.5	235±5°C for 5±0.5 Seconds	95% Min. Coverage
Resistance to Solvent	JIS-C-5202 6.9	IPA for 1 Min. with Ultrasonic	No Deterioration of Coatings and Markings
Terminal Strength	Direct Load for 10 sec. in The Direction of The Terminal Leads		≥2.5kg (24.5N)
Pulse Overload	JIS-C-5202 5.8	4 Times RCWV 10000 Cycles (1 Sec. on , 25 Sec. off)	±(1%+0.05Ω)
Load Life in Humidity	JIS-C-5202 7.9	40±2°C, 90~95% RH at RCWV for 1000 Hrs. (1.5 Hrs. on , 0.5 Hrs. off)	±(1.5%+0.05Ω)
Load Life	JIS-C-5202 7.10	70°C at RCWV for 1000 Hrs. (1.5 Hrs. on , 0.5 Hrs. off)	±(1.5%+0.05Ω)
Temperature Cycling	JIS-C-5202 7.4	-55°C→Room Temp.→+155°C→Room Temp. for 5 Cycles	±(0.75%+0.05Ω)
Resistance to Soldering Heat	JIS-C-5202 6.4	350°C±10°C for 3±0.5 Seconds	±(0.25%+0.05Ω)

* Rated Continuous Working Voltage (RCWV)= $\sqrt{\text{Power Rating} \times \text{Resistance Value}}$

Metal Film Resistors

POWER FLAME-PROOF Type

Normal Style [FMP Series]

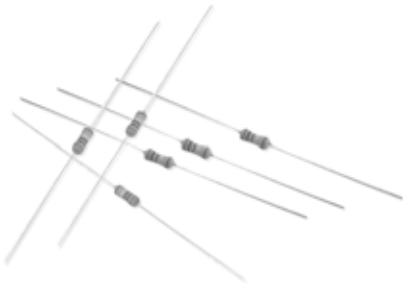

GENERAL PURPOSE

Power Rating : 1/2W, 1W, 2W, 3W

Resistance Tolerance : $\pm 1\%$, $\pm 5\%$

High thermal conductivity and specific gravity rods

FlameProof Silicone Coating : UL94V-0

Pink body color

POWER DERATING CURVE

For resistors operated in ambient temperatures above 70°C , power rating must be derated in accordance with the curve below.

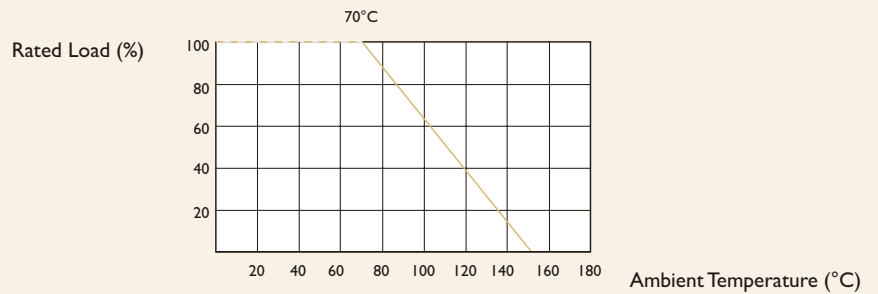

DIMENSIONS

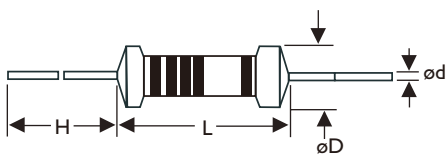

Unit : mm

STYLE	L	øD	H	ød
FMP-50	3.4±0.3	1.9±0.2	28±2.0	0.5±0.05
FMP100	6.3±0.5	2.4±0.2	28±2.0	0.6±0.05
FMP200	9.0±0.5	3.9±0.3	26±2.0	0.6±0.05
FMP300	15.5±1.0	5.0±0.5	33±2.0	0.8±0.05



Note :

ELECTRICAL CHARACTERISTICS

STYLE	TEST METHOD	FMP-50	FMP100	FMP200	FMP300
Power Rating at 70°C		1/2W	1W	2W	3W
Maximum Working Voltage		200V	350V	500V	750V
Maximum Overload Voltage		400V	600V	700V	1000V
Dielectric Withstanding Voltage	JIS-C-5202 5.7 in V-Block for 60 Seconds	300V	500V	500V	750V
Temperature Coefficient	JIS-C-5202 5.2 Room Temp. Add 100°C	±100ppm/°C			
Short Time Overload	JIS-C-5202 5.5 2.5 Times RCWV for 5 Sec.	±2.0%+0.05Ω			
Insulation Resistance	JIS-C-5202 5.6 in V-Block	>1,000MΩ			
Pulse Overload	JIS-C-5202 5.8 4 Times RCWV 10,000 Cycles (1 Sec. on , 25 Sec. off)	±1.0%+0.05Ω			
Operating Temp. Range		-55°C to + 155°C			
Value Rang ±1%		10Ω To 1MΩ for E24 or E96 Series			
Value Range ±5%		1Ω To 1MΩ for E24 Series			

* Resistance range for standard resistance, below or over this resistance on request.

ENVIRONMENTAL CHARACTERISTICS

PERFORMANCE TEST	TEST METHOD	APPRAISE
Terminal Strength	JIS-C-5202 6.1 Direct load for 10 Sec. in the Direction of the Terminal Leads	≥2.5kg (24.5N)
Resistance to Soldering Heat	JIS-C-5202 6.4 350°C ± 10°C for 3 ± 0.5 Seconds	±0.25%+0.05Ω
Solderability	JIS-C-5202 6.5 235°C ± 5°C for 5 ± 0.5 Seconds	95% Min. Coverage
Resistance to Solvent	JIS-C-5202 6.9 IPA for 1 Min. with Ultrasonic	No Deterioration of Coatings and Markings
Temperature Cycling	JIS-C-5202 7.4 -55°C → Room Temp. → +155°C → Room Temp. for 5 Cycles	±1.0%+0.05Ω
Humidity	JIS-C-5202 7.5 40±2°C, 90~95% RH for 1,000 Hrs.	±1.0%+0.05Ω
Load Life in Humidity	JIS-C-5202 7.9 40±2°C, 90~95% RH at RCWV for 1,000 Hrs. (1.5 Hrs. on , 0.5 Hrs. off)	±2.0%+0.05Ω
Load Life	JIS-C-5202 7.10 70°C at RCWV for 1,000 Hrs. (1.5 Hrs. on, 0.5 Hrs. off)	±2.0%+0.05Ω
Overload Flame Retardant	JIS-C-5202 7.12 4 Times RCWV for 1 minute	No evidence of flaming or arcing

* Rated Continuous Working Voltage (RCWV) = $\sqrt{\text{Power Rating} \times \text{Resistance Value}}$

Metal Oxide Film Resistors

FLAME-PROOF TYPE

Normal & Miniature Style [RSF Series]

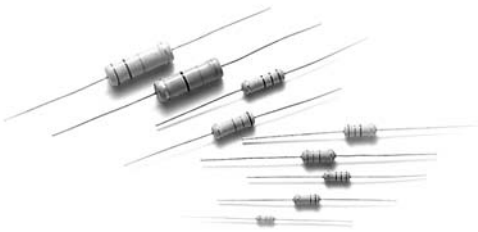

INTRODUCTION

These Metal Oxide Resistors offer excellent performance in applications where stability and uniformity of characteristics are desired. They provide lower cost alternatives to Carbon Composition Resistors and General Purpose Metal Films. Metal Oxides also can replace many low power General Purpose wirewound applications, saving both money and time, with shorter delivery cycles.

The normal style & the miniature style of RSF series are coated with layers of gray and pink colors flame-proof lacquer respectively.

DIMENSIONS

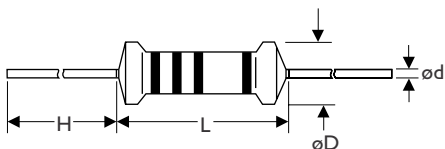

FEATURES

- Low Cost, Prompt Delivery
- High Power-to-Size Ratio for Significant Space Savings
- Flameproof Silicone Coating (UL94V-0)
- High Surge/Overload Capability
- Non-Inductive Design
- Wide Resistance Range: $1\Omega \sim 1M\Omega$
- Resistance ToLerance: $\pm 5\%$

DERATING CURVE

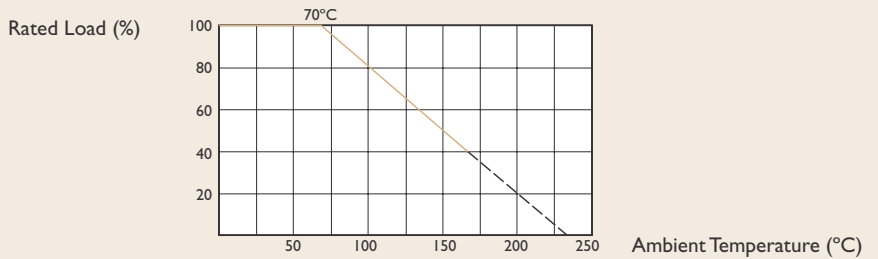

HOT-SPOT TEMPERATURE

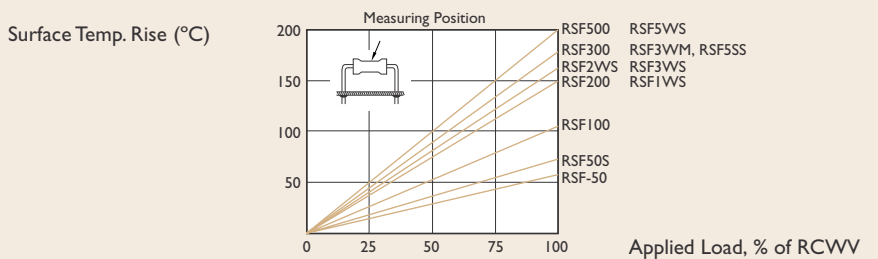

Unit : mm

STYLE		DIMENSION			
Normal	Miniature	L	øD	H	ød
RSF-25	RSF50S	6.3±0.5	2.4±0.2	28±2.0	0.6±0.05
RSF-50	RSF1WS	9.0±0.5	3.3±0.3	26±2.0	0.6±0.05
RSF100	RSF2WS	11.5±1.0	4.5±0.5	35±2.0	0.8±0.05
RSF200	RSF3WS	15.5±1.0	5.0±0.5	33±2.0	0.8±0.05
RSF5SS	RSF3WM	17.5±1.0	6.5±1.0	32±2.0	0.8±0.05
RSF300	RSF5WS	24.5±1.0	8.5±1.0	38±2.0	0.8±0.05
RSF500	-	24.5±1.0	8.5±1.0	38±2.0	0.8±0.05

* RSFIWS (MB Type) ød0.8±0.05



Note :

ELECTRICAL CHARACTERISTICS

STYLE	RSF-25	RSF50S	RSF-50	RSF1WS	RSF100	RSF2WS	RSF200	RSF3WS/ RSF3WM	RSF300	RSF5SS/ RSF5WS	RSF500
Power Rating at 70°C	1/4W	1/2W		1W		2W		3W		5W	
Operating Temp. Range	-55°C to +155°C										
Maximum Working Voltage	200V	250V	250V	300V	350V	350V	350V	350V/450V	500V	500V/500V	750V
Maximum Overload Voltage	300V	400V	400V	500V	600V	600V	600V	600V/700V	800V	800V/800V	1000V
Dielectric Withstanding Voltage	250V	350V	350V	400V	500V	500V	500V	500V/600V	700V	700V/750V	750V
Value Range ±5%	1Ω~1MΩ										
Temperature Coefficient	±300ppm/°C										

* Standard resistance is 1Ω~1MΩ, below or over this resistance on request.

ENVIRONMENTAL CHARACTERISTICS

PERFORMANCE TEST	TEST METHOD		APPRAISE
Short Time Overload	JIS-C-5202 5.5	2.5 Times RCWV for 5 Seconds	±(1%+0.05Ω)
Dielectric Withstanding Voltage	JIS-C-5202 5.7	in V-Block for 60 Seconds	by Type
Temperature Coefficient of Resistance	JIS-C-5202 5.2	-55°C to +155°C	±300ppm/°C
Insulation Resistance	JIS-C-5202 5.6	in V-Block	>1000MΩ
Solderability	JIS-C-5202 6.5	235±5°C for 5±0.5 Seconds	95% Min. Coverage
Resistance to Solvent	JIS-C-5202 6.9	IPA for 1 Min. with Ultrasonic	No Deterioration of Coatings and Markings
Terminal Strength	Direct Load for 10 Sec. in The Direction of The Terminal Leads		≥2.5kg (24.5N)
Pulse Overload	JIS-C-5202 5.8	4 Times RCWV 10000 Cycles (1 Sec. on , 25 Sec. off)	±(2%+0.05Ω)
Load Life in Humidity	JIS-C-5202 7.9	40±2°C, 90~95% RH at RCWV for 1000 Hrs. (1.5 Hrs. on , 0.5 Hrs. off)	±(5%+0.05Ω)
Load Life	JIS-C-5202 7.10	70°C at RCWV for 1000 Hrs. (1.5 Hrs. on , 0.5 Hrs. off)	±(5%+0.05Ω)
Temperature Cycling	JIS-C-5202 7.4	-55°C→Room Temp.→+155°C→Room Temp. for 5 Cycles	±(1%+0.05Ω)
Resistance to Soldering Heat	JIS-C-5202 6.4	350°C±10°C for 3±0.5 Seconds	±(1%+0.05Ω)

* Rated Continuous Working Voltage (RCWV)= $\sqrt{\text{Power Rating} \times \text{Resistance Value}}$

Metal Film Resistors

FUSIBLE Type

Normal & Miniature Style [FRM Series]

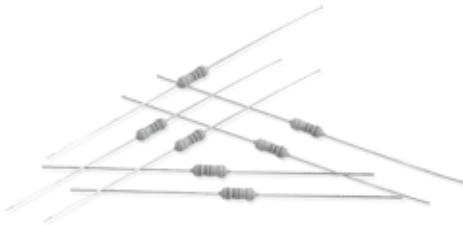

FEATURES

Power Rating : 1/4W, 1/2W, 1W, 2W

Resistance tolerance : $\pm 5\%$

FlameProof Silicone Coating : UL94V-0

Gray body color

The 5th color band is white to represent fusible resistors

POWER DERATING CURVE

For resistors operated in ambient temperatures above 70°C, power rating must be derated in accordance with the curve below.

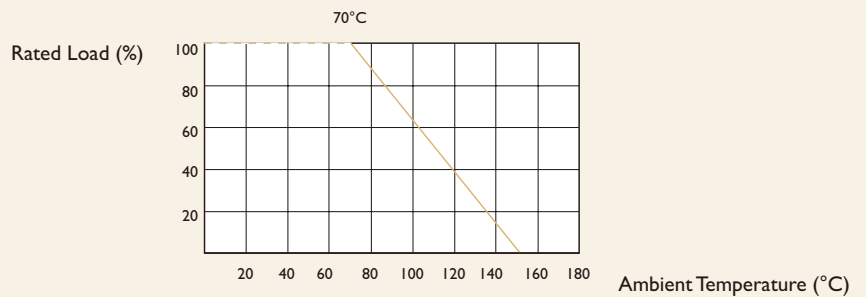

FUSING CHARACTERISTICS

Fusing time within 30 seconds at 16 times of rated power

Fusing residual resistive value at least 100 times rated resistance

DIMENSIONS

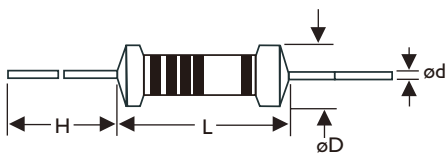

Unit : mm

STYLE		DIMENSION			
Normal	Miniature	L	øD	H	ød
FRM-25	FRM50S	6.3±0.5	2.4±0.2	28±2.0	0.6±0.05
FRM-50	FRM1WS	9.0±0.5	3.3±0.3	26±2.0	0.6±0.05
FRM100	FRM2WS	11.5±1.0	4.5±0.5	35±2.0	0.8±0.05
FRM200	FRM3WS	15.5±1.0	5.0±0.5	33±2.0	0.8±0.05



Note :

ELECTRICAL CHARACTERISTICS

STYLE	TEST METHOD	FRM-25	FRM50S	FRM-50	FRM1WS	FRM100	FRM2WS	FRM200	FRM3WS
Power Rating at 70°C		1/4W	1/2W		1W		2W		3W
Dielectric Withstanding Voltage	JIS-C-5202 5.7 in V-Block for 60 Seconds	250V	250V	250V	250V	350V	350V	350V	350V
Temperature Coefficient	JIS-C-5202 5.2 Room Temp.Add 100°C	±200ppm/°C							
Short Time Overload	JIS-C-5202 5.5 2.5 Times RCWV for 5 Seconds	±2.0%+0.05Ω							
Insulation Resistance	JIS-C-5202 5.6 in V-Block	>100MΩ							
Pulse Overload	JIS-C-5202 5.8 4 Times RCWV 10,000 Cycles (1 Sec. on , 25 Sec. off)	±1.0%+0.05Ω(for Normal Style) ±2.0%+0.05Ω(for Miniature Style)							
Operating Temp. Range		-55°C to + 155°C							
Value Range		2.2Ω To 1KΩ for E24 Series							

* Resistance range for standard resistance, below or over this resistance on request.

ENVIRONMENTAL CHARACTERISTICS

PERFORMANCE TEST	TEST METHOD	APPRAISE
Terminal Strength	JIS-C-5202 6.1 Direct load for 10 Sec. in the Direction of the Terminal Leads	≥2.5kg (24.5N)
Resistance to Soldering Heat	JIS-C-5202 6.4 350°C ± 10°C for 3 ± 0.5 Seconds	±1.0%+0.05Ω
Solderability	JIS-C-5202 6.5 235±5°C ± 5°C for 5 ± 0.5 Seconds	95% Min. Coverage
Resistance to Solvent	JIS-C-5202 6.9 IPA for 1 Min. with Ultrasonic	No Deterioration of Coatings and Markings
Temperature Cycling	JIS-C-5202 7.4 -55°C→Room Temp.→+155°C→Room Temp. for 5 Cycles	±2.0%+0.05Ω
Humidity	JIS-C-5202 7.5 40±2°C, 90~95% RH for 1,000 Hrs.	±5.0%+0.05Ω
Load Life in Humidity	JIS-C-5202 7.9 40±2°C, 90~95% RH at RCWV for 1,000 Hrs. (1.5 Hrs. on , 0.5 Hrs. off)	±5.0%+0.05Ω
Load Life	JIS-C-5202 7.10 70°C at RCWV for 1,000 Hrs. (1.5 Hrs. on, 0.5 Hrs. off)	±5.0%+0.05Ω
Overload Flame Retardant	JIS-C-5202 7.12 4 Times RCWV for 1 minute	No evidence of flaming or arcing

* Rated Continuous Working Voltage (RCWV)= $\sqrt{\text{Power Rating} \times \text{Resistance Value}}$

Metal Film Resistors

MFL Type

Low Values Style [MFL Series]

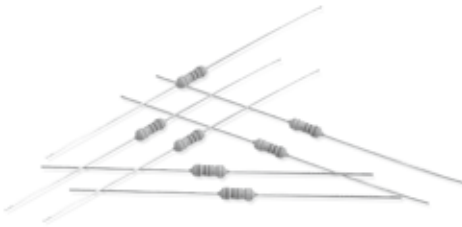

INTRODUCTION

The MFL Series Metal Film Low Values Resistors are manufactured using vacuum sputtering system to deposit multiple layers of mixed metals and passivative materials onto a carefully treated high grade ceramic substrate, the resistors are coated with layers of blue lacquer.

FEATURES

Power Rating	1/4W ,1/2W ,0.6W
Resistance Tolerance	±1%
T.C.R	100ppm/°C

DERATING CURVE

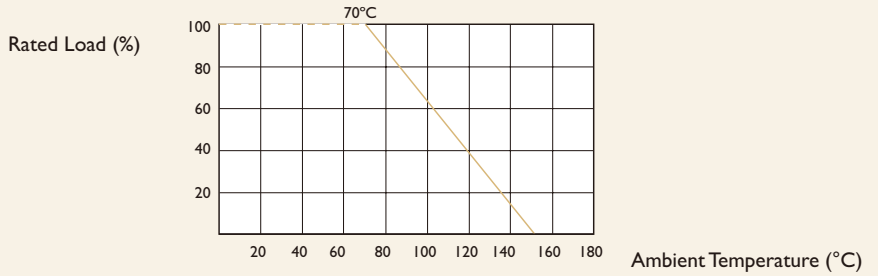

HOT-SPOT TEMPERATURE

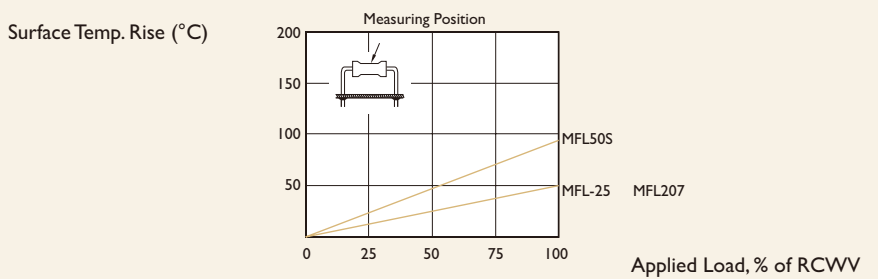

DIMENSIONS

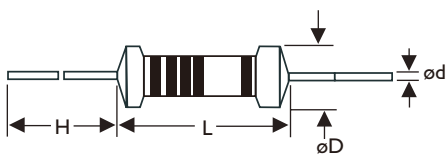

Unit : mm

STYLE		DIMENSION			
Normal	Miniature	L	øD	H	ød
MFL-25	MFL50S	6.3±0.5	2.4±0.2	28±2.0	0.6±0.05
	MFL207	6.3±0.5	2.4±0.2	28±2.0	0.6±0.05



Note :

ELECTRICAL CHARACTERISTICS

STYLE	MFL-25	MFL50S	MFL207
Power Rating at 70°C	1/4W	1/2W	0.6W
Operating Temp. Range	- 55°C to+ 155°C		
Maximum Working Voltage	250V	300V	300V
Maximum Overload Voltage	500V	600V	600V
Dielectric Withstanding Voltage	500V	500V	500V
Value Range , ± 1%	OR 1Ω~OR91Ω for E24 Series values		
Temperature Coefficient(by Type)	± 100ppm/°C		

* Resistance range for standard resistance , below or over this resistance on request.

ENVIRONMENTAL CHARACTERISTICS

PERFORMANCE TEST	TEST METHOD		APPRAISE
Short Time Overload	JIS-C-5202 5.5	2.5 Times RCWV for 5 Seconds	±(0.25%+0.05Ω)
Dielectric Withstanding Voltage	JIS-C-5202 5.7	in V-Block for 60 Seconds	by Type
Temperature Coefficient of Resistance	JIS-C-5202 5.2	-55°C to +155°C	by Type
Insulation Resistance	JIS-C-5202 5.6	in V-Block	> 10000MΩ
Solderability	JIS-C-5202 6.5	235±5°C for 5±0.5 Seconds	95% Min. Coverage
Resistance to Solvent	JIS-C-5202 6.9	IPA for 1 Min. with Ultrasonic	No Deterioration of Coatings and Markings
Terminal Strength	Direct Load for 10 Sec. in The Direction of The Terminal Leads		≥2.5kg (24.5N)
Pulse Overload	JIS-C-5202 5.8	4 Times RCWV 10000 Cycles (1 Sec. on , 25 Sec. off)	±(1%+0.05Ω)
Load Life in Humidity	JIS-C-5202 7.9	40±2°C, 90~95% RH at RCWV for 1000 Hrs. (1.5 Hrs. on , 0.5 Hrs. off)	±(1.5%+0.05Ω)
Load Life	JIS-C-5202 7.10	70°C at RCWV for 1000 Hrs. (1.5 Hrs. on , 0.5 Hrs. off)	±(1.5%+0.05Ω)
Temperature Cycling	JIS-C-5202 7.4	-55°C→Room Temp.→+155°C→Room Temp. for 5 Cycles	±(0.75%+0.05Ω)
Resistance to Soldering Heat	JIS-C-5202 6.4	350°C±10°C for 3±0.5 Seconds	±(0.25%+0.05Ω)

* Rated Continuous Working Voltage (RCWV)= $\sqrt{\text{Power Rating} \times \text{Resistance Value}}$

Melf Metal Film Resistors

MMF Type

Normal & Miniature Style [MMF Series]



FEATURES

Power Rating	1/6W, 1/4W, 1/2W, 1W, 2W
Resistance Tolerance	±0.1%, ±0.25%, ±0.5%, ±1%
T.C.R	±15ppm/°C, ±25ppm/°C, ±50ppm/°C, ±100ppm/°C

DERATING CURVE

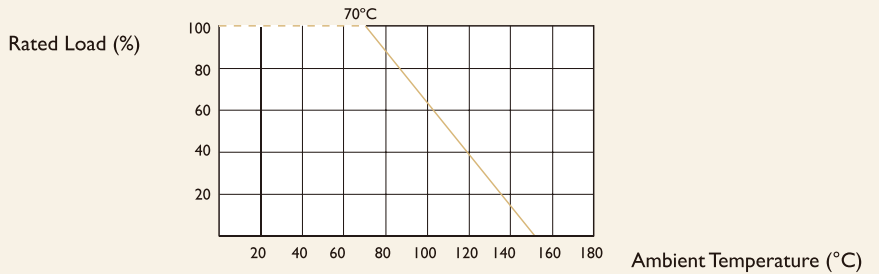

DIMENSIONS

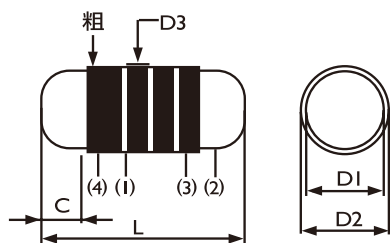

STYLE		DIMENSION			
Normal	Miniature	L	D1	D2max	Cmin
MMF-12	MMF25S/MMF204	3.5±0.2	1.4±0.15	1.55	0.5
MMF-25	MMF50S/MMF207	5.9± 0.2	2.2±0.15	2.4	0.5
MMF-50	MMF1WS	8.5± 0.2	3.2±0.20	3.4	0.5

Unit : mm



Note :

ELECTRICAL CHARACTERISTICS

STYLE	MMF-12	MMF25S	MMF204	MMF-25	MMF50S	MMF207	MMF-50	MMF1WS
Power Rating at 70 °C	1/6W	1/4W	0.4W	1/4W	1/2W	0.6W	1/2W	1W
Maximum Working Voltage	150V	200V	200V	250V	300V	300V	350V	350V
Maximum Overload Voltage	300V	400V	400V	500V	600V	600V	700V	700V
Operating Temp. Range	- 55°C to +155°C							
Standard Value Range	1Ω~10MΩ							
Temperature Coefficient	±25ppm/°C, ±50ppm/°C, ±100ppm/°C							

* Standard resistance is 1Ω~10MΩ, below or over this resistance on request.

ENVIRONMENTAL CHARACTERISTICS

PERFORMANCE TEST	TEST METHOD		APPRAISE
Short Time Overload	JIS-C-5202 5.5	2.5 Times RCWV for 5 Seconds	±(0.25%+0.05Ω)
Dielectric Withstanding Voltage	JIS-C-5202 5.7	in V-Block for 60 Seconds	by Type
Temperature Coefficient of Resistance	JIS-C-5202 5.2	-55°C to +155°C	by Type
Insulation Resistance	JIS-C-5202 5.6	in V-Block	>10000MΩ
Solderability	JIS-C-5202 6.5	235±5°C for 5±0.5 Seconds	95% Min. Coverage
Resistance to Solvent	JIS-C-5202 6.9	IPA for 1 Min. with Ultrasonic	No Deterioration of Coatings and Markings
Terminal Strength	Direct Load for 10 Sec. in The Direction of The Terminal Leads		≥2.5kg (24.5N)
Pulse Overload	JIS-C-5202 5.8	4 Times RCWV 10000 Cycles (1 Sec. on , 25 Sec. off)	±(1%+0.05Ω)
Load Life in Humidity	JIS-C-5202 7.9	40±2°C, 90~95% RH at RCWV for 1000 Hrs. (1.5 Hrs. on , 0.5 Hrs. off)	±(1.5%+0.05Ω)
Load Life	JIS-C-5202 7.10	70°C at RCWV for 1000 Hrs. (1.5 Hrs. on , 0.5 Hrs. off)	±(1.5%+0.05Ω)
Temperature Cycling	JIS-C-5202 7.4	-55°C→Room Temp.→+155°C→Room Temp. for 5 Cycles	±(0.75%+0.05Ω)
Resistance to Soldering Heat	JIS-C-5202 6.4	350°C±10°C for 3±0.5 Seconds	±(0.25%+0.05Ω)

* Rated Continuous Working Voltage (RCWV)= $\sqrt{\text{Power Rating} \times \text{Resistance Value}}$

Melf Metal Film Resistors

MMP Type

Power Type Normal Style [MMP Series]



FEATURES

Power Rating	1W, 2W
Resistance Tolerance	±1%, ±2%, ±5%
High thermal conductivity and specific gravity rods	
Flame Proof Silicone Coating: UL94V-0	
Pink body color	

POWER DERATING CURVE

For resistors operated in ambient temperatures above 70°C, power rating must be derated in accordance with the curve below.

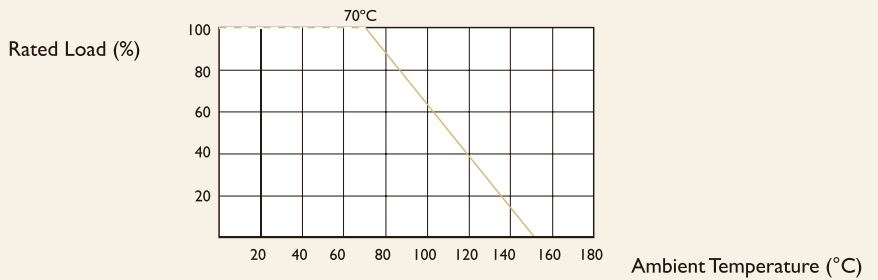

DIMENSIONS

Unit : mm

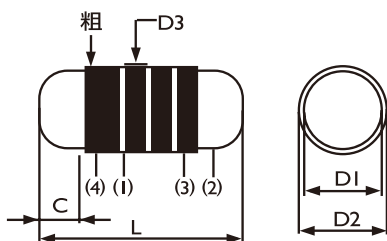

STYLE	L	D1	D2max	Cmin
MMP100	5.9±0.2	2.2±0.15	2.4	0.5
MMP200	8.5± 1.0	3.2±0.20	3.4	0.5



Note :

ELECTRICAL CHARACTERISTICS

STYLE	TEST METHOD	MMP100	MMP200
Power Rating at 70°C		1W	2W
Maximum Overload Voltage		700V	700V
Maximum Working Voltage		350V	350V
Dielectric Withstanding Voltag	JIS-C-5202 5.7 in V-Block for 60 Seconds	500V	500V
Temperature Coefficient	JIS-C-5202 5.2 Room Temp.Add 100°C	±50, ±100 ,±200ppm/°C	
Short Time Overload	JIS-C-5202 5.5 2.5 Times RCWV for 5Seconds	±2.0% +0.05Ω	
Insulation Resistance	JIS-C-5202 5.6 in V-Block	>1000MΩ	
Pulse Overload	JIS-C-5202 5.8 4Times RCWV 1000Hrs Cycles (1sec.on,25sec.off)	±1.0 % +0.05Ω	
Operating Temp. Range		- 55°C to +155°C	
Value Range , ±0.5 % ±1%		10Ω To 1MΩ for E240 or E90 Series	
Value Range ±5 %		1Ω To 1MΩ for E24 Series	

* Standard resistance is 1Ω~1MΩ, below or over this resistance on request.

ENVIRONMENTAL CHARACTERISTICS

PERFORMANCE TEST	TEST METHOD	APPRAISE
Terminal Strength	JIS-C-5202 6.1 Direct load for 10 sec.in the direction of the terminal leads	≥2.5kg(24.5N)
Resistance to Soldering Heat	JIS-C-5202 6.4 350°C±10°Cfor 3±0.5 Seconds	±0.25% ±0.05Ω
Solderability	JIS-C-5202 6.5 235±5°Cfor 5±0.5 Seconds	95% Min. Coverage
Resistance to Solvent	JIS-C-5202 6.9 IPA for 1 Min..with Ultrasonic	No Deterioration of Coatings and Markings
Temperature Cycling	JIS-C-5202 7.4 -55→Room Temp.→+155°C→Room Temp. for5Cycles	±1.0 % +0.05Ω
Humidity	JIS-C-5202 7.5 40±2°C, 90~95% RH for 1,000Hrs	±1.0 % +0.05Ω
Load Life in Humidity	JIS-C-5202 7.9 40±2°C,90~95% RH at RCWV for 1000Hrs (1.5 Hrs. on , 0.5 Hrs. off)	±2.0%+0.05Ω
Load Life	JIS-C-5202 7.10 70°Cat RCWV for 1000Hrs. (1.5Hrs.on,0.5Hrs.off)	±2.0%+0.05Ω
Overload Flame Retardant	JIS-C-5202 7.12 4Times RCWV for 1 minute.	No evidence of Flaming or arcing

* Rated Continuous Working Voltage (RCWV)= $\sqrt{\text{Power Rating} \times \text{Resistance Value}}$

Carbon Film Resistors

CFR Type

Normal & Miniature Style [CFR Series]



INTRODUCTION

Billions of products are already in use worldwide in all types of applications—from process control instrumentation to telephone receivers and FM radio to color television.

The secret is in a proprietary production system and baking by a uniquely designed and automated production technique. Years of experience in making raw materials and production machinery prove the unique quality and high reliability of these products.

The meet-or far exceed such specifications as EIA RS196A, JIS-C-6402 and IEC-115.

The resistors are coated with layers of tan color lacquer.

FEATURES

Industry's Lowest Cost

Delivery From Stock in Bulk, Taped and Strip Pack

Exceptional Long-Term Stability

Exceeds Carbon Comp MIL-R-11 Performance

Resistance Tolerance: $\pm 2\%$, $\pm 5\%$

Variety of Packaging—Bulk, Strip Pack, 26mm and 52mm Tape and Reel, Cut and Formed, or Radial Panaset/Avisert

DERATING CURVE

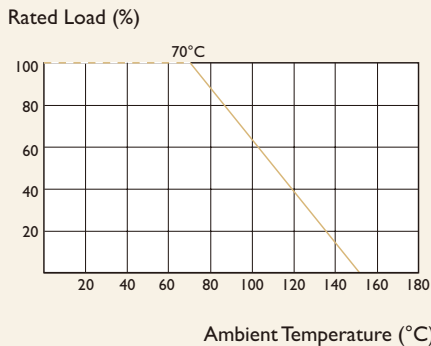

HOT-SPOT TEMPERATURE

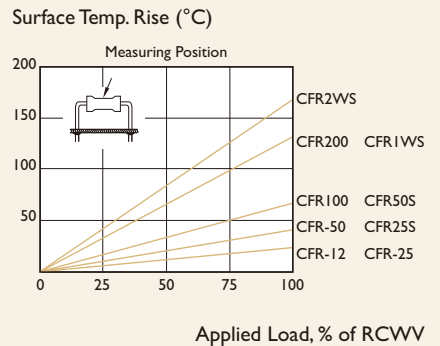
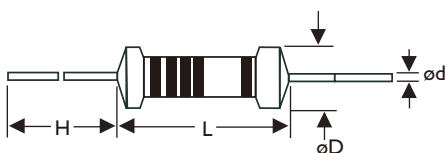

TABLE I TEMPERATURE COEFFICIENT

STYLE	Max. Value of Temp. Coefficient ppm/°C		
	under 100K Ω	100K Ω ~ 1M Ω	1M Ω ~ 10M Ω
CFR 100, CFR200, CFR2WS	± 350	-500	-1500
CFR-12, CFR-25, CFR-50, CFR25S, CFR50S, CFR1WS	+350	-700	-1500
CFR-12, CFR-25, CFR-50, CFR25S, CFR50S, CFR1WS	-500		

DIMENSIONS



Unit : mm

STYLE		DIMENSION			
Normal	Miniature	L	øD	H	ød
CFR-12	CFR25S	3.4 \pm 0.3	1.9 \pm 0.2	28 \pm 2.0	0.5 \pm 0.05
CFR-25	CFR50S	6.3 \pm 0.5	2.4 \pm 0.2	28 \pm 2.0	0.6 \pm 0.05
CFR-50	CFR1WS	9.0 \pm 0.5	3.3 \pm 0.3	26 \pm 2.0	0.6 \pm 0.05
CFR100	CFR2WS	11.5 \pm 1.0	4.5 \pm 0.5	35 \pm 2.0	0.8 \pm 0.05
CFR200	-	15.5 \pm 1.0	5.0 \pm 0.5	33 \pm 2.0	0.8 \pm 0.05



Note :

ELECTRICAL CHARACTERISTICS

STYLE	CFR-12	CFR25S	CFR-25	CFR50S	CFR-50	CFR1WS	CFR100	CFR2WS	CFR200
Power Rating at 70°C	1/6W	1/4W		1/2W		1W		2W	
Operating Temp. Range	-55°C to +155°C								
Maximum Working Voltage	150V	200V	250V	300V	350V	400V	500V	500V	500V
Maximum Overload Voltage	300V	400V	500V	600V	700V	800V	1000V	1000V	1000V
Dielectric Withstanding Voltage	300V	400V	500V	500V	500V	700V	1000V	1000V	1000V
Value Range ±2%, ±5%	1Ω~10MΩ								
Temperature Coefficient (by Type)	see TABLE I								

* Standard resistance is 1Ω~10MΩ, below or over this resistance on request.

ENVIRONMENTAL CHARACTERISTICS

PERFORMANCE TEST	TEST METHOD		APPRAISE
Short Time Overload	JIS-C-5202 5.5	2.5 Times RCWV for 5 Seconds	±(0.75%+0.05Ω)
Dielectric Withstanding Voltage	JIS-C-5202 5.7	in V-Block for 60 Seconds	by Type
Temperature Coefficient of Resistance	JIS-C-5202 5.2	-55°C to +155°C	by Type
Insulation Resistance	JIS-C-5202 5.6	in V-Block	>1000MΩ
Solderability	JIS-C-5202 6.5	235±5°C for 5±0.5 Seconds	95% Min. Coverage
Resistance to Solvent	JIS-C-5202 6.9	IPA for 1 Min. with Ultrasonic	No Deterioration of Coatings and Markings
Terminal Strength	Direct Load for 10 Sec. in The Direction of The Terminal Leads		≥2.5kg (24.5N)
Pulse Overload	JIS-C-5202 5.8	4 Times RCWV 10000 Cycles (1 Sec. on , 25 Sec. off)	±(1%+0.05Ω)
Load Life in Humidity	JIS-C-5202 7.9	40±2°C, 90~95% RH at RCWV for 1000 Hrs. (1.5 Hrs. on , 0.5 Hrs. off)	±(3%+0.05Ω)
Load Life	JIS-C-5202 7.10	70°C at RCWV for 1000 Hrs. (1.5 Hrs. on , 0.5 Hrs. off)	±(3%+0.05Ω)
Temperature Cycling	JIS-C-5202 7.4	-55°C→Room Temp.→+155°C→Room Temp. for 5 Cycles	±(1%+0.05Ω)
Resistance to Soldering Heat	JIS-C-5202 6.4	350°C±10°C for 3±0.5 Seconds	±(1%+0.05Ω)

* Rated Continuous Working Voltage (RCWV)= $\sqrt{\text{Power Rating} \times \text{Resistance Value}}$

Carbon Film Resistors

PROFESSIONAL Type Miniature Style [CF0 Series]



INTRODUCTION

The CF0 series are manufactured by Coating a homogeneous film of pure carbon on high grade ceramic rods, resistance less than 10Ω have an electroless-deposited nickel film. The resistors are coated with layers of tan color lacquer.

FEATURES

- Excellent Long-Term Stability
- Miniature in Size
- Resistance Tolerance: ±5%
- Resistance Range: 1Ω~10MΩ

DERATING CURVE

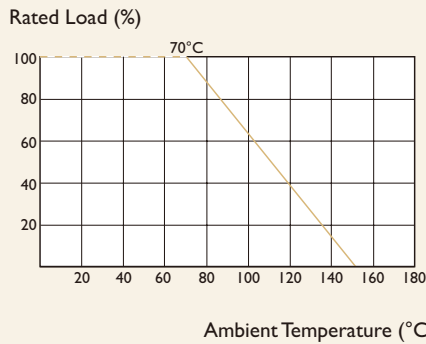

HOT-SPOT TEMPERATURE

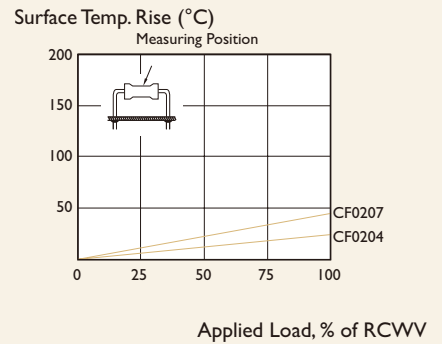
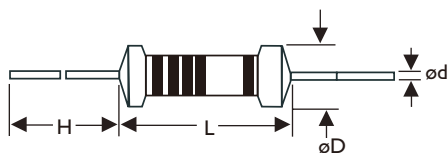

TABLE I TEMPERATURE COEFFICIENT

STYLE	Max. Value of Temp. Coefficient ppm/°C		
	under 100KΩ	100KΩ ~ 1MΩ	1MΩ ~ 10MΩ
CF0204, CF0207	+350	-700	-1500
	-500		

DIMENSIONS

Unit : mm



STYLE	L	øD	H	ød
CF0204	3.4±0.3	1.9±0.2	28±2.0	0.5±0.05
CF0207	6.3±0.5	2.4±0.2	28±2.0	0.6±0.05



Note :

ELECTRICAL CHARACTERISTICS

STYLE	CF0204	CF0207
Power Rating at 70°C	0.4W	0.6W
Operating Temp. Range	-55°C to +155°C	
Maximum Working Voltage	200V	300V
Maximum Overload Voltage	400V	600V
Dielectric Withstanding Voltage	300V	500V
Value Range ±5%	1Ω~10MΩ	
Temp. Coefficient (by Type)	see TABLE I	

* Standard resistance is 1Ω~10MΩ, below or over this resistance on request.

ENVIRONMENTAL CHARACTERISTICS

PERFORMANCE TEST	TEST METHOD		APPRAISE
Short Time Overload	JJS-C-5202 5.5	2.5 Times RCWV for 5 Seconds	±(0.75%+0.05Ω)
Dielectric Withstanding Voltage	JJS-C-5202 5.7	in V-Block for 60 Seconds	by Type
Temperature Coefficient of Resistance	JJS-C-5202 5.2	-55°C to +155°C	by Type
Insulation Resistance	JJS-C-5202 5.6	in V-Block	>1000MΩ
Solderability	JJS-C-5202 6.5	235±5°C for 5±0.5 Seconds	95% Min. Coverage
Resistance to Solvent	JJS-C-5202 6.9	IPA for 1 Min. with Ultrasonic	No Deterioration of Coatings and Markings
Terminal Strength	Direct Load for 10 Sec. in The Direction of The Terminal Leads		≥2.5kg (24.5N)
Pulse Overload	JJS-C-5202 5.8	4 Times RCWV 10000 Cycles (1 Sec. on , 25 Sec. off)	±(1%+0.05Ω)
Load Life in Humidity	JJS-C-5202 7.9	40±2°C, 90~95% RH at RCWV for 1000 Hrs. (1.5 Hrs. on , 0.5 Hrs. off)	±(3%+0.05Ω)
Load Life	JJS-C-5202 7.10	70°C at RCWV for 1000 Hrs. (1.5 Hrs. on , 0.5 Hrs. off)	±(3%+0.05Ω)
Temperature Cycling	JJS-C-5202 7.4	-55°C→Room Temp.→+155°C→Room Temp. for 5 Cycles	±(1%+0.05Ω)
Resistance to Soldering Heat	JJS-C-5202 6.4	350°C±10°C for 3±0.5 Seconds	±(1%+0.05Ω)

* Rated Continuous Working Voltage (RCWV)= $\sqrt{\text{Power Rating} \times \text{Resistance Value}}$

Carbon Film Resistors

FLAME-PROOF Type

Normal & Miniature Style [FCR Series]

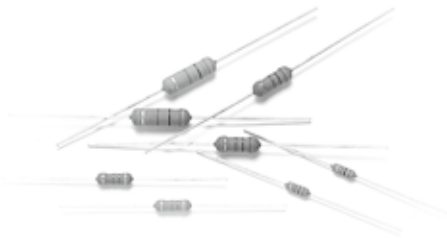

INTRODUCTION

The FCR series flame-proof Carbon Film Resistors are manufactured by Coating a homogeneous film of pure carbon on high grade ceramic rods, resistance less than 10Ω have an electroless deposited nickel film, and are coated with layers of gray color flame-proof lacquer. These resistors meet overload tests in accordance with UL specification #1412 without producing a fire hazard.

FEATURES

- Low Cost. Prompt Delivery
- High Power-to-Size Ratio for Significant Space Savings
- Flameproof Silicone Coating (UL94V-0)
- Excellent Long-Term Stability
- Wide Resistance Range: 1Ω~10MΩ
- Resistance Tolerance: ±5%

DERATING CURVE

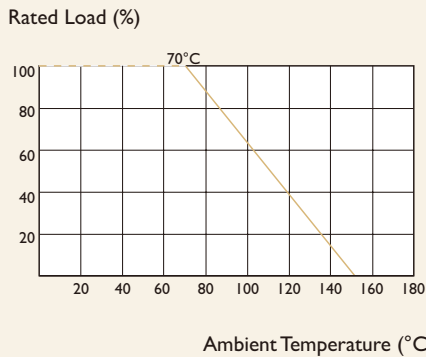

HOT-SPOT TEMPERATURE

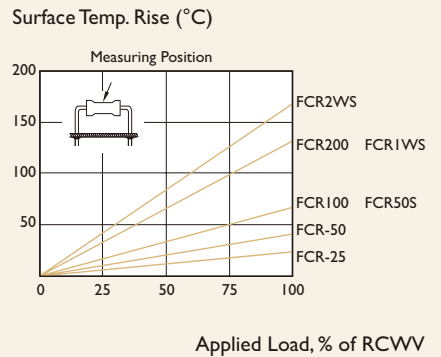
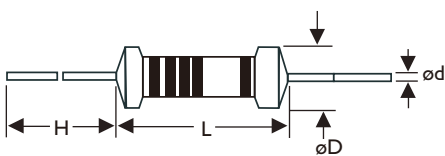

TABLE I TEMPERATURE COEFFICIENT

STYLE	Max. Value of Temp. Coefficient ppm/°C		
	under 100KΩ	100KΩ ~ 1MΩ	1MΩ ~ 10MΩ
FCR100, FCR200, FCR2WS	±350	-500	-1500
FCR-25, FCR-50,	+350	-700	-1500
FCR50S, FCR1WS	-500		

DIMENSIONS



*The 5th is black color band for FCR series

STYLE		DIMENSION				Unit : mm
Normal	Miniature	L	øD	H	ød	
FCR-25	FCR50S	6.3±0.5	2.4±0.2	28±2.0	0.6±0.05	
FCR-50	FCR1WS	9.0±0.5	3.3±0.3	26±2.0	0.6±0.05	
FCR100	FCR2WS	11.5±1.0	4.5±0.5	35±2.0	0.8±0.05	
FCR200	-	15.5±1.0	5.0±0.5	33±2.0	0.8±0.05	



Note :

ELECTRICAL CHARACTERISTICS

STYLE	FCR-25	FCR50S	FCR-50	FCR1WS	FCR100	FCR2WS	FCR200
Power Rating at 70°C	1/4W	1/2W		1W		2W	
Operating Temp. Range	-55°C to +155°C						
Maximum Working Voltage	250V	300V	350V	400V	500V	500V	500V
Maximum Overload Voltage	500V	600V	700V	800V	1000V	1000V	1000V
Dielectric Withstanding Voltage	400V	400V	500V	600V	750V	750V	750V
Value Range ±2%, ±5%	1Ω~10MΩ						
Temperature Coefficient (by Type)	see TABLE I						

* Standard resistance is 1Ω~10MΩ, below or over this resistance on request.

ENVIRONMENTAL CHARACTERISTICS

PERFORMANCE TEST	TEST METHOD	APPRAISE
Short Time Overload	JIS-C-5202 5.5	2.5 Times RCWV for 5 Seconds ±(0.75%+0.05Ω)
Dielectric Withstanding Voltage	JIS-C-5202 5.7	in V-Block for 60 Seconds by Type
Temperature Coefficient of Resistance	JIS-C-5202 5.2	-55°C to +155°C by Type
Insulation Resistance	JIS-C-5202 5.6	in V-Block >1000MΩ
Solderability	JIS-C-5202 6.5	235±5°C for 5±0.5 Seconds 95% Min. Coverage
Resistance to Solvent	JIS-C-5202 6.9	IPA for 1 Min. with Ultrasonic No Deterioration of Coatings and Markings
Terminal Strength	Direct load for 10 Sec. in The Direction of The Terminal Leads ≥2.5kg (24.5N)	
Pulse Overload	JIS-C-5202 5.8	4 Times RCWV 10000 Cycles (1 Sec. on , 25 Sec. off) ±(1%+0.05Ω)
Load Life in Humidity	JIS-C-5202 7.9	40±2°C, 90~95% RH at RCWV for 1000 Hrs. (1.5 Hrs. on , 0.5 Hrs. off) ±(3%+0.05Ω)
Load Life	JIS-C-5202 7.10	70°C at RCWV for 1000 Hrs. (1.5 Hrs. on , 0.5 Hrs. off) ±(3%+0.05Ω)
Temperature Cycling	JIS-C-5202 7.4	-55°C→Room Temp.→+155°C→Room Temp. for 5 Cycles ±(1%+0.05Ω)
Resistance to Soldering Heat	JIS-C-5202 6.4	350°C±10°C for 3±0.5 Seconds ±(1%+0.05Ω)

* Rated Continuous Working Voltage (RCWV)=√ Power Rating x Resistance Value

Carbon Film Resistors

PROFESSIONAL & FLAME-PROOF Type

Miniature Style [FC0 Series]

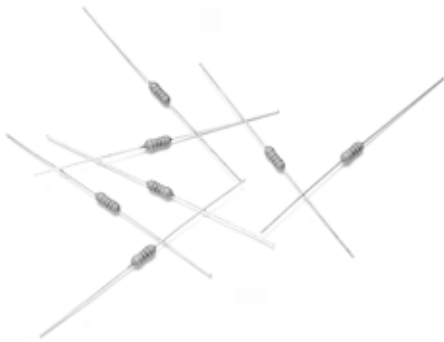

INTRODUCTION

The FC0 series are manufactured by Coating a homogeneous film of pure carbon on high grade ceramic rods, resistance less than 10Ω have an electroless-deposited nickel film. The FC0207 are coated with layers of green color flame-proof lacquer. The FC0207 resistors meet overload test in accordance with UL specification #1412 without producing a fire hazard.

FEATURES

- Excellent Long-Term Stability
- Miniature in Size
- Flameproof Silicone Coating (UL94V-0)
- Resistance Tolerance: ±5%
- Resistance Range: 1Ω~10MΩ

DERATING CURVE

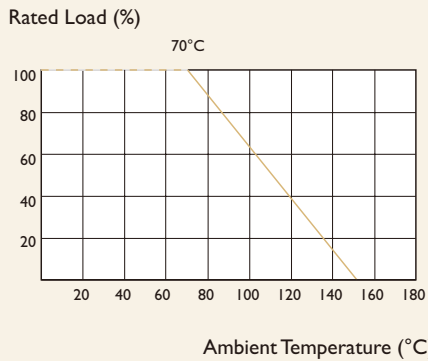

HOT-SPOT TEMPERATURE

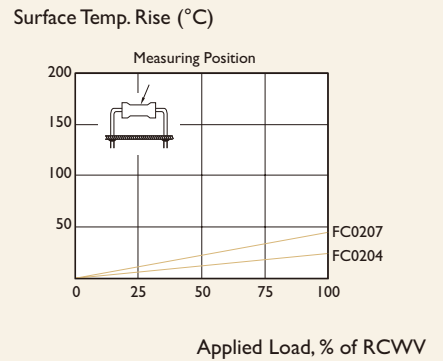
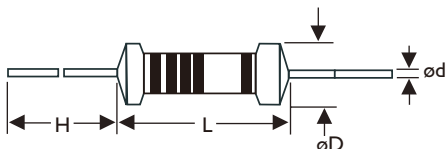

TABLE I TEMPERATURE COEFFICIENT

STYLE	Max. Value of Temp. Coefficient ppm/°C		
	under 100KΩ	100KΩ ~ 1MΩ	1MΩ ~ 10MΩ
FC0204, FC0207	+350	-700	-1500
	-500		

DIMENSIONS



STYLE	L	øD	H	ød
FC0204	3.4±0.3	1.9±0.2	28±2.0	0.5±0.05
FC0207	6.3±0.5	2.4±0.2	28±2.0	0.6±0.05

Unit : mm



Note :

ELECTRICAL CHARACTERISTICS

STYLE	FC0204	FC0207
Power Rating at 70°C	0.4W	0.6W
Operating Temp. Range	-55°C to +155°C	
Maximum Working Voltage	200V	300V
Maximum Overload Voltage	400V	600V
Dielectric Withstanding Voltage	300V	500V
Value Range ±5%	1Ω~10MΩ	
Temperature Coefficient (by Type)	see TABLE I	

* Standard resistance is 1Ω~10MΩ, below or over this resistance on request.

ENVIRONMENTAL CHARACTERISTICS

PERFORMANCE TEST	TEST METHOD		APPRAISE
Short Time Overload	JIS-C-5202 5.5	2.5 Times RCWV for 5 Seconds	±(0.75%+0.05Ω)
Dielectric Withstanding Voltage	JIS-C-5202 5.7	in V-Block for 60 Seconds	by Type
Temperature Coefficient of Resistance	JIS-C-5202 5.2	-55°C to +155°C	by Type
Insulation Resistance	JIS-C-5202 5.6	in V-Block	>1000MΩ
Solderability	JIS-C-5202 6.5	235±5°C for 5±0.5 Seconds	95% Min. Coverage
Resistance to Solvent	JIS-C-5202 6.9	IPA for 1 Min. with Ultrasonic	No Deterioration of Coatings and Markings
Terminal Strength	Direct Load for 10 Sec. in The Direction of The Terminal Leads		≥2.5kg (24.5N)
Pulse Overload	JIS-C-5202 5.8	4 Times RCWV 10000 Cycles (1 Sec. on , 25 Sec. off)	±(1%+0.05Ω)
Load Life in Humidity	JIS-C-5202 7.9	40±2°C, 90~95% RH at RCWV for 1000 Hrs. (1.5 Hrs. on , 0.5 Hrs. off)	±(3%+0.05Ω)
Load Life	JIS-C-5202 7.10	70°C at RCWV for 1000 Hrs. (1.5 Hrs. on , 0.5 Hrs. off)	±(3%+0.05Ω)
Temperature Cycling	JIS-C-5202 7.4	-55°C→Room Temp.→+155°C→Room Temp. for 5 Cycles	±(1%+0.05Ω)
Resistance to Soldering Heat	JIS-C-5202 6.4	350°C±10°C for 3±0.5 Seconds	±(1%+0.05Ω)

* Rated Continuous Working Voltage (RCWV)= $\sqrt{\text{Power Rating} \times \text{Resistance Value}}$

Carbon Film Resistors

NON INDUCTIVE Type

Normal & Miniature Style [NCR Series]



FEATURES

Power Rating : 1/4W, 1/2WS, 1/2W, 1WS, 1W, 2WS, 2W, 3WS

Resistance Tolerance : $\pm 5\%$, $\pm 10\%$

FlameProof Silicone Coating : UL94V-0

Gray body color

The 5th color band is green to represent non-inductive resistors

Inductance : $< 1 \mu\text{H}$

POWER DERATING CURVE

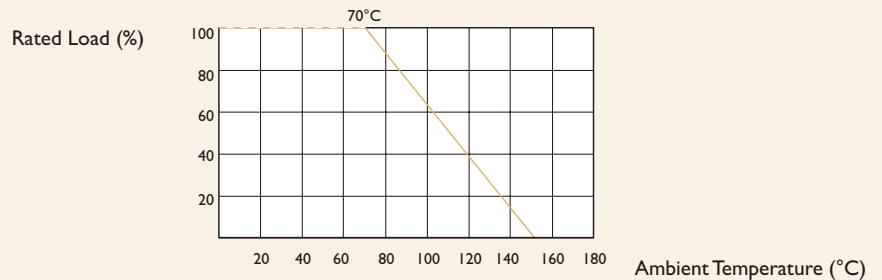

DIMENSIONS

Unit : mm

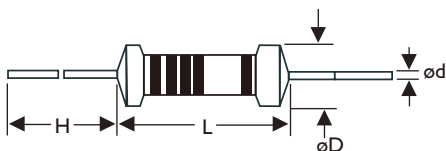

STYLE		DIMENSION			
Normal	Miniature	L	øD	H	ød
NCR-25	NCR50S	6.3 \pm 0.5	2.4 \pm 0.2	28 \pm 2.0	0.6 \pm 0.05
NCR-50	NCR1WS	9.0 \pm 0.5	3.3 \pm 0.3	26 \pm 2.0	0.7 \pm 0.05
NCR100	NCR2WS	11.5 \pm 1.0	4.5 \pm 0.5	35 \pm 2.0	0.8 \pm 0.05
NCR200	NCR3WS	15.5 \pm 1.0	5.0 \pm 0.5	33 \pm 2.0	0.8 \pm 0.05



Note :

ELECTRICAL CHARACTERISTICS

STYLE	TEST METHOD	NCR-25	NCR50S	NCR-50	NCR1WS	NCR100	NCR2WS	NCR200	NCR3WS
Power Rating at 70°C		1/4W	1/2W		1W		2W		3W
Dielectric Withstanding Voltage	JIS-C-5202 5.7 in V-Block for 60 Seconds	500V	500V	700V	700V	1000V	1000V	1000V	1000V
Temperature Coefficient	JIS-C-5202 5.2 Room Temp.Add 100°C	±500ppm/°C							
Short Time Overload	JIS-C-5202 5.5 2.5 Times RCWV for 5 Seconds	±0.75%+0.05Ω	±2.0%+0.05Ω						
Insulation Resistance	JIS-C-5202 5.6 in V-Block	>1,000MΩ							
Pulse Overload	JIS-C-5202 5.8 4 Times RCWV 10,000 Cycles (1 Sec. on , 25 Sec. off)	±0.75%+0.05Ω	±1.0%+0.05Ω						
Operating Temp. Range		-55°C to + 155°C							
Value Range		2.2Ω To 6KΩ for E24 Series							

* Resistance range for standard resistance, below or over this resistance on request.

ENVIRONMENTAL CHARACTERISTICS

PERFORMANCE TEST	TEST METHOD	APPRAISE
Terminal Strength	JIS-C-5202 6.1 Direct load for 10 Sec. in the Direction of the Terminal Leads	≥2.5kg (24.5N)
Resistance to Soldering Heat	JIS-C-5202 6.4 350°C ± 10°C for 3 ± 0.5 Seconds	±1.0%+0.05Ω
Solderability	JIS-C-5202 6.5 235°C ± 5°C for 5 ± 0.5 Seconds	95% Min. Coverage
Resistance to Solvent	JIS-C-5202 6.9 IPA for 1 Min. with Ultrasonic	No Deterioration of Coatings and Markings
Temperature Cycling	JIS-C-5202 7.4 -55°C→Room Temp.→+155°C→Room Temp. for 5 Cycles	±1.0%+0.05Ω
Humidity	JIS-C-5202 7.5 40±2°C, 90~95% RH for 1,000 Hrs.	±1.0%+0.05Ω
Load Life in Humidity	JIS-C-5202 7.9 40±2°C, 90~95% RH at RCWV for 1,000 Hrs. (1.5 Hrs. on , 0.5 Hrs. off)	±3.0%+0.05Ω
Load Life	JIS-C-5202 7.10 70°C at RCWV for 1,000 Hrs. (1.5 Hrs. on, 0.5 Hrs. off)	±3.0%+0.05Ω
Overload Flame Retardant	JIS-C-5202 7.12 4 Times RCWV for 1 minute	No evidence of flaming or arcing

* Rated Continuous Working Voltage (RCWV)= $\sqrt{\text{Power Rating} \times \text{Resistance Value}}$

Melf Carbon Film Resistors

MCF Type

Normal & Miniature Style [MCF Series]



FEATURES

- Industry's Lowest Cost
- Delivery From Stock in Taped and Reel, Bulk
- Exceptional Long-Term Stability
- Exceeds Carbon Comp MIL-R-111 Performance
- Power Rating: 1/8W, 1/4W, 1/2W, 1W
- Resistance Tolerance: $\pm 2\%$, $\pm 5\%$

DERATING CURVE

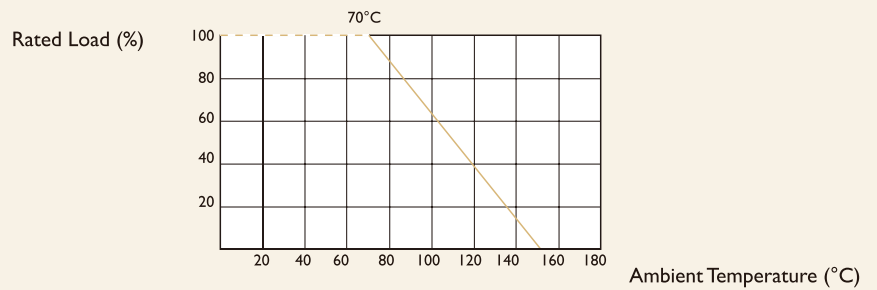
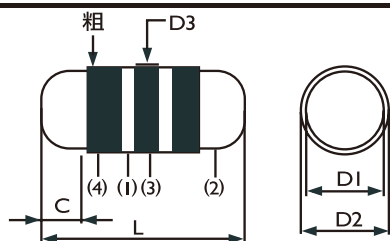

TABLE I TEMPERATURE COEFFICIENT

STYLE	Max. Value of Temp. Coefficient ppm/°C		
	under 100K Ω	100K Ω ~1M Ω	1M Ω ~10M Ω
MCF100, MCF200, MCF2WS	± 350	-500	-1500
MCF-12, MCF-25, MCF-50	+350	-700	-1500
MCF25S, MCF50S, MCF1WS	-500		

DIMENSIONS



Unit : mm

STYLE	DIMENSION	DIMENSION			
		L	D1	D2 max	C min
Normal	Miniature				
MCF-12	MCF25S/MCF204	3.5 \pm 0.2	1.4 \pm 0.15	1.55	0.5
MCF-25	MCF50S/MCF207	5.9 \pm 0.2	2.2 \pm 0.15	2.4	0.5
MCF-50	MCF1WS	8.5 \pm 0.2	3.2 \pm 0.20	3.4	0.5



Note :

ELECTRICAL CHARACTERISTICS

STYLE	MCF-12	MCF25S	MCF204	MCF-25	MCF50S	MCF207	MCF-50	MCF1WS
Power Rating at 70°C	1/6W	1/4W	0.4W	1/4W	1/2W	0.6W	1/2W	1W
Maximum Working Voltage	150V	200V	200V	250V	300V	300V	350V	350V
Maximum Overload Voltage	300V	400V	400V	500V	600V	600V	700V	700V
Open Temp. Range	-55°C to +155°C							
Standard Value Range	1Ω~10MΩ							
Temperature Coefficient	See table I							

* Standard resistance is 1Ω~10MΩ, below or over this resistance on request

ENVIRONMENTAL CHARACTERISTICS

PERFORMANCE TEST	TEST METHOD		APPRAISE
Short Time Overload	JIS-C-5202 5.5	2.5Times RCWV for 5 Seconds	±(0.75%+0.05Ω)
Dielectric Withstanding Voltage	JIS-C-5202 5.7	in V-Block for 60 Seconds	by Type
Temperature Coefficient of Resistance	JIS-C-5202 5.2	-55°C to +155°C	by Type
Insulation Resistance	JIS-C-5202 5.6	in V-Block	>1000MΩ
Solderability	JIS-C-5202 6.5	235±5°C for 5±0.5 Seconds	95% Min.Coverage
Resistance to Solvent	JIS-C-5202 6.9	IPA for 1 Min. with Ultrasonic	No Deterioration of Coatings and Markigs
Terminal Strength	Direct Load for 10 Sec. in the Direction of The Terminal Leads		≥2.5kg(24.5N)
Pulse Overload	JIS-C-5202 5.8	4 Times RCWV 10000 Cycles(1 Sec. on, 25 Sec. of)	±(1%+0.05Ω)
Load Life in Humidity	JIS-C-5202 7.9	40±2°C, 90~95% RH at RcWV for 1000 Hrs. (1.5 Hrs. on, 0.5 Hrs. off)	±(3%+0.05Ω)
Load Life	JIS-C-5202 7.10	70°C at RCWV for 1000 Hrs.(1.5 Hrs. on, 0.5 Hrs. off)	±(3%+0.05Ω)
Temperature Cycling	JIS-C-5202 7.4	-55°C→Room Temp.→+155°C→Room Temp. for 5 Cycles	±(1%+0.05Ω)
Resistance to Soldering Heat	JIS-C-5202 6.4	350°C±10°C for 3±0.5 Seconds	±(1%+0.05Ω)

* Rated Continuous Working Voltage (RCWV)= $\sqrt{\text{Power Rating} \times \text{Resistance Value}}$

Melf Carbon Film Resistors

MCP Type

Power Type Miniature [MCP Series]



FEATURES

- Industry's Lowest Cost
- Delivery From Stock in Taped and Reel, Bulk
- Exceptional Long-Term Stability
- Exceeds Carbon Comp MIL-R-11 Performance
- Power Rating: 1/8W, 1/4W, 1/2W, 1W
- Resistance Tolerance: $\pm 2\%$, $\pm 5\%$

DERATING CURVE

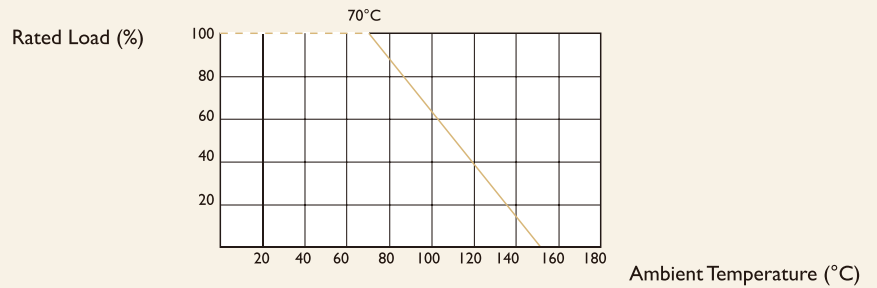
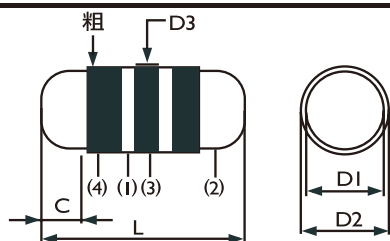

TABLE I TEMPERATURE COEFFICIENT

STYLE	Max. Value of Temp. Coefficient ppm/°C		
	under 100K Ω	100K Ω ~1M Ω	1M Ω ~10M Ω
MCP1SS, MCP2SS	+350	-700	-1500

DIMENSIONS



Unit : mm

STYLE	DIMENSION			
	L	D1	D2 max	C
Miniature				
MCP1SS	5.9 \pm 0.2	2.2 \pm 0.15	2.4	0.5
MCP2SS	8.5 \pm 0.2	3.2 \pm 0.20	3.4	0.5



Note :

ELECTRICAL CHARACTERISTICS

STYLE	MCP1SS	MCP2SS
Power Rating at 70°C	1W	2W
Maximum Working Voltage	350V	350V
Maximum Overload Voltage	700V	700V
Open Temp. Range	-55°C to +155°C	
Standard Value Range	1Ω~10MΩ	
Temperature Coefficient	See table I	

* Standard resistance is 1Ω~10MΩ, below or over this resistance on request

ENVIRONMENTAL CHARACTERISTICS

PERFORMANCE TEST	TEST METHOD	APPRAISE
Short Time Overload	JIS-C-5202 5.5 2.5Times RCWV for 5 Seconds	±(0.75%+0.05Ω)
Dielectric Withstanding Voltage	JIS-C-5202 5.7 in V-Block for 60 Seconds	by Type
Temperature Coefficient of Resistance	JIS-C-5202 5.2 -55°C to +155°C	by Type
Insulation Resistance	JIS-C-5202 5.6 in V-Block	>1000MΩ
Solderability	JIS-C-5202 6.5 235±5°C for 5±0.5 Seconds	95% Min.Coverage
Resistance to Solvent	JIS-C-5202 6.9 IPA for 1 Min. with Ultrasonic	No Deterioration of Coatings and Markigs
Terminal Strength	Direct Load for 10 Sec. in the Direction of The Terminal Leads	≥2.5kg(24.5N)
Pulse Overload	JIS-C-5202 5.8 4 Times RCWV 10000 Cycles(1 Sec. on, 25 Sec. of)	±(1%+0.05Ω)
Load Life in Humidity	JIS-C-5202 7.9 40±2°C, 90~95% RH at RcWV for 1000 Hrs. (1.5 Hrs. on, 0.5 Hrs. off)	±(3%+0.05Ω)
Load Life	JIS-C-5202 7.10 70°C at RCWV for 1000 Hrs.(1.5 Hrs. on, 0.5 Hrs. off)	±(3%+0.05Ω)
Temperature Cycling	JIS-C-5202 7.4 -55°C→Room Temp.→+155°C→Room Temp. for 5 Cycles	±(1%+0.05Ω)
Resistance to Soldering Heat	JIS-C-5202 6.4 350°C±10°C for 3±0.5 Seconds	±(1%+0.05Ω)

* Rated Continuous Working Voltage (RCWV)= $\sqrt{\text{Power Rating} \times \text{Resistance Value}}$

Zerohm Resistors

ZOR Type

Normal Style [ZOR Series]



INTRODUCTION

- Similar to a 1/4W resistor (1/6W size also available, typical resistance 0.004Ω)
- Ideal for automatic insertion or Cut and Form
- Available in Tape/Reel, Tape/Box and Bulk
- Film type Zerohm also available in 1/4W (ZOR-25) and 1/6W (ZOR-12) size

SPECIFICATIONS

Maximum Resistance	0.005Ω
Min. Insulation Resistance	
Dry	10,000MΩ
Wet	100MΩ
Min. Dielectric Withstanding Voltage	
Atmospheric	500V RMS
Reduced	325V RMS
Insulation Flammability	Resistor Insulation is Self Extinguishing within 10 Seconds After Externally Applied Flame is Removed
Current Rating	15 AMPS at 70°C for 1/4W 10 AMPS at 70°C for 1/6W

DIMENSIONS

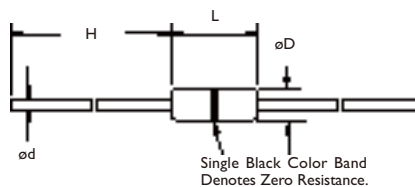

Unit : mm

STYLE	L	øD	H	ød
ZOR-12	3.3±0.3	1.8±0.3	28±2.0	0.5±0.05
ZOR-25	6.3±0.5	2.3±0.3	28±2.0	0.6±0.05

JPW Type

Normal Style [JPW Series]

Jumper Wires Resistors

SPECIFICATIONS

Material of Jumper Wire	Soft Copper Wire with Tin Plating		
Conductor Resistance	0.005Ω/cm		
Wire Diameter	ø0.5·ø0.6·ø0.7·ø0.8·ø1.0(±0.05mm)		
Tension Strength	CNS 8938 within 28kg/mm ²		
Extension Rate	CNS 8938 ø0.5~ø0.6mm	over 24%	
	CNS 8938 ø0.7~ø1.0mm	over 26%	
Conductivity	ø0.5mm	Minimum 94%	
	ø0.6~ø1.0mm	Minimum 96%	
Twisting Strength	CNS 8938 ø0.5mm	Load 250 g	3 cycles
	CNS 8938 ø0.6~ø0.8mm	Load 500 g	3 cycles
	CNS 8938 ø1.0mm	Load 1.0 kg	3 cycles
Solderability	JIS520 6-5 235°C±5°C , 5±0.5 sec. Coverage 95%		
Element of Plating	JIS-H310I Tin Minimum 99%		
Thickness of Plating	3~5μ		
	ø0.5mm	6 AMPS at 70°C	
Current Rating	ø0.6mm	7.5 AMPS at 70°C	
	ø0.7mm	8.5 AMPS at 70°C	
	ø0.8mm	10 AMPS at 70°C	
	ø1.0mm	15 AMPS at 70°C	
Appearance	Smooth and Shining		



INTRODUCTION

Jumper wires or crossovers, as they are sometimes called, are basically interconnection devices between points on a P.C.Board. Generally they are used for the following reasons:

- Inability to connect two points on a P.C. Board due to other circuit paths which must be crossed over.
 - An After-the-Fact design change that requires new point connections.
 - Circuit tuning by changing point connections.
- Jumper wires offers a quick simple solution to these problems.They are especially suited for automatic machine insertion on lead tape or available in all packaging styles including pre-cut and formed leads for manual insertion.

DIMENSIONS

Unit : mm

STYLE	ød	L		
JPW-05	0.5±0.05	26±1	52.4±1	—
JPW-06	0.6±0.05	26±1	52.4±1	73±1
JPW-07	0.7±0.05	26±1	52.4±1	73±1
JPW-08	0.8±0.05	26±1	52.4±1	73±1
JPW-10	1.0±0.05	26±1	52.4±1	73±1

Wire Wound Resistors

FLAME-PROOF Type

Normal & Miniature Style [KNP Series]

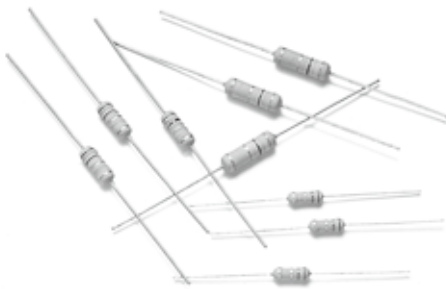

INTRODUCTION

- The resistor is fabricated using a suitable fiberglass or ceramic core with the resistance wire securely crimped to the terminals
- Small in size comparatively than other kind resistor
- Electrical and Mechanical stability and high reliability
- The KNP/NKN series are coated with layers of green color flame-proof lacquer. The resistors meet overload tests in accordance with UL specification #1412 without producing a fire hazard

GENERAL PURPOSE

Power Rating : 1/4W, 1/2W, 1W, 2W, 3W, 5W, 7W

Resistance Tolerance : $\pm 1\%$, $\pm 5\%$

FlameProof Silicone Coating : UL94V-0

Green body color

Stable performance in diverse environments

High safety standard

POWER DERATING CURVE

For resistors operated in ambient temperatures above 20°C , power rating must be derated in accordance with the curve below.

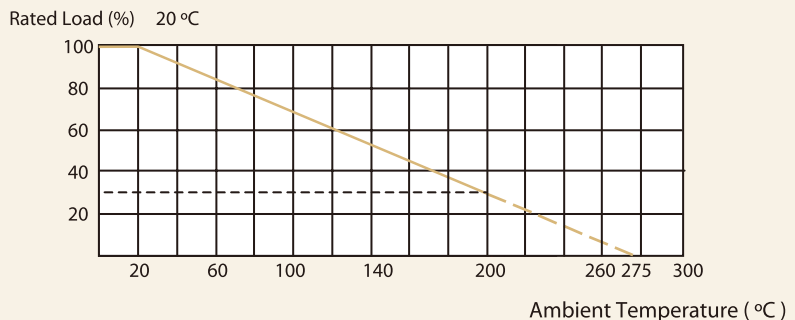

DIMENSIONS

Unit : mm

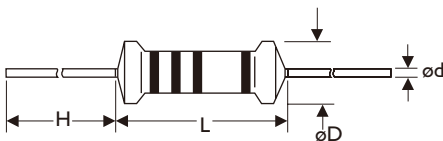

STYLE		DIMENSION			
Normal	Miniature	L	øD	H	ød
KNP-25	KNP50S	6.3±0.5	2.5±0.3	28±2.0	0.6±0.05
KNP-50	KNP1WS	9.0±0.5	3.3±0.3	26±2.0	0.6±0.05
KNP100	KNP2WS	11.5±1.0	4.5±0.5	35±2.0	0.8±0.05
KNP200	KNP3WS	15.5±1.0	5.0±0.5	33±2.0	0.8±0.05
KNP300	KNP5WS	17.5±1.0	6.5±1.0	32±2.0	0.8±0.05
KNP500	KNP7WS	24.5±1.0	8.5±1.0	39±2.0	0.8±0.05



Note :

ELECTRICAL CHARACTERISTICS

STYLE	KNP-25	KNP50S	KNP-50	KNP1WS	KNP100	KNP2WS	KNP200	KNP3WS	KNP300	KNP5WS	KNP500	KNP7WS	
Power Rating	1/4W	1/2W		1W		2W		3W		5W		7W	
Operating Temp. Range	-55°C TO +155°C												
Dielectric Withstanding Voltage	300V	300V	300V	300V	400V	400V	400V	400V	400V	400V	400V	400V	
Value Range ±5%	0.1Ω-47Ω			0.1Ω-100Ω			0.1Ω-300Ω			0.1Ω-560Ω			0.1Ω-1KΩ
Temperature Coefficient	±400ppm/°C												

* Resistance range for standard resistance, below or over this resistance on request.

ENVIRONMENTAL CHARACTERISTICS

PERFORMANCE TEST	TEST METHOD	APPRAISE
Terminal Strength	JIS-C-5202 6.1 Direct load for 10 Sec. in the Direction of the Terminal Leads	≥2.5kg (24.5N)
Resistance to Soldering Heat	JIS-C-5202 6.4 350°C ± 10°C for 3 ± 0.5 Seconds	±1.0%+0.05Ω
Solderability	JIS-C-5202 6.5 235°C ± 5°C for 5 ± 0.5 Seconds	95% Min. Coverage
Resistance to Solvent	JIS-C-5202 6.9 IPA for 1 Min. with Ultrasonic	No Deterioration of Coatings and Markings
Temperature Cycling	JIS-C-5202 7.4 -55°C→Room Temp.→+155°C→Room Temp. for 5 Cycles	±1.0%+0.05Ω
Humidity	JIS-C-5202 7.5 40±2°C, 90~95% RH for 1,000 Hrs.	±3.0%+0.05Ω
Load Life in Humidity	JIS-C-5202 7.9 40±2°C, 90~95% RH at RCWV for 1,000 Hrs. (1.5 Hrs. on, 0.5 Hrs. off)	±5.0%+0.05Ω
Load Life	JIS-C-5202 7.10 70°C at RCWV for 1,000 Hrs. (1.5 Hrs. on, 0.5 Hrs. off)	±5.0%+0.05Ω
Overload Flame Retardant	JIS-C-5202 7.12 4 Times RCWV for 1 minute	No evidence of flaming or arcing

* Rated Continuous Working Voltage (RCWV)= $\sqrt{\text{Power Rating} \times \text{Resistance Value}}$

Wire Wound Resistors

NON INDUCTIVE Type

Normal & Miniature Style [NKN Series]

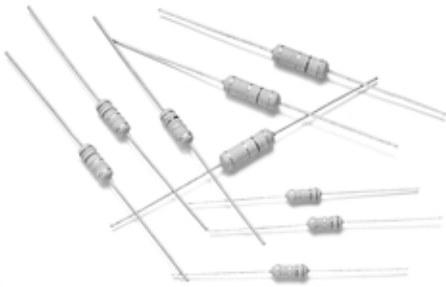

GENERAL PURPOSE

Power Rating : 1/2W, 1WS, 1W, 2WS, 2W, 3WS, 3W, 5WS, 5W, 7WS

Resistance Tolerance : $\pm 5\%$

FlameProof Silicone Coating : UL94V-0

Green body color

The 5th color band is black to represent non-inductive resistors

High safety standard

POWER DERATING CURVE

For resistors operated in ambient temperatures above 20°C , power rating must be derated in accordance with the curve below.

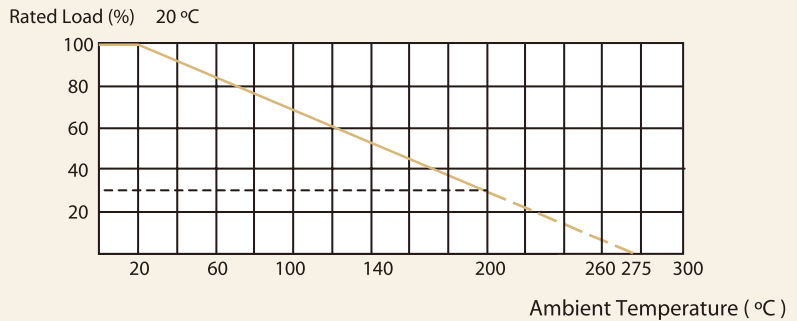

DIMENSIONS

Unit : mm

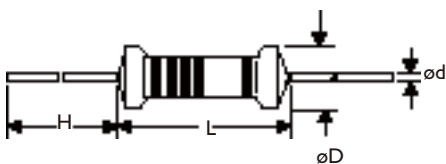

STYLE		DIMENSION			
Normal	Miniature	L	øD	H	ød
NKN-50	NKN1WS	9.0±0.5	3.3±0.3	26±2.0	0.6±0.05
NKN100	NKN2WS	11.5±1.0	4.5±0.5	35±2.0	0.8±0.05
NKN200	NKN3WS	15.5±1.0	5.0±0.5	33±2.0	0.8±0.05
NKN300	NKN5WS	17.5±1.0	6.5±1.0	32±2.0	0.8±0.05
NKN500	NKN7WS	24.5±1.0	8.5±1.0	39±2.0	0.8±0.05



Note :

ELECTRICAL CHARACTERISTICS

STYLE	NKN-50	NKN1WS	NKN100	NKN2WS	NKN200	NKN3WS	NKN300	NKN5WS	NKN500	NKN7WS
Power Rating AT 70°C	1/2W	1W		2W		3W		5W		7W
Standard Value Range ±5%	0.1Ω-5Ω		0.1Ω-10Ω		0.1Ω-22Ω		0.1Ω-27Ω		0.1Ω-33Ω	0.1Ω-27Ω
Dielectric Withstanding Voltage	250V									
Minimum Value Range ±5%	0.05Ω									
Operating Temp. Range	-40°C to +200°C									
Temperature Coefficient	±300ppm/°C									

* Resistance range for standard resistance, below or over this resistance on request.

ENVIRONMENTAL CHARACTERISTICS

PERFORMANCE TEST	TEST METHOD	APPRAISE
Terminal Strength	JIS-C-5202 6.1 Direct load for 10 Sec. in the Direction of the Terminal Leads	≥2.5kg (24.5N)
Resistance to Soldering Heat	JIS-C-5202 6.4 350°C ± 10°C for 3 ± 0.5 Seconds	±1.0%+0.05Ω
Solderability	JIS-C-5202 6.5 235°C ± 5°C for 5 ± 0.5 Seconds	95% Min. Coverage
Resistance to Solvent	JIS-C-5202 6.9 IPA for 1 Min. with Ultrasonic	No Deterioration of Coatings and Markings
Temperature Cycling	JIS-C-5202 7.4 -55°C→Room Temp.→+155°C→Room Temp. for 5 Cycles	±1.0%+0.05Ω
Humidity	JIS-C-5202 7.5 40±2°C, 90~95% RH for 1,000 Hrs.	±3.0%+0.05Ω
Load Life in Humidity	JIS-C-5202 7.9 40±2°C, 90~95% RH at RCWV for 1,000 Hrs. (1.5 Hrs. on , 0.5 Hrs. off)	±5.0%+0.05Ω
Load Life	JIS-C-5202 7.10 70°C at RCWV for 1,000 Hrs. (1.5 Hrs. on, 0.5 Hrs. off)	±5.0%+0.05Ω
Overload Flame Retardant	JIS-C-5202 7.12 4Times RCWV for 1 minute	No evidence of flaming or arcing

* Rated Continuous Working Voltage (RCWV)= $\sqrt{\text{Power Rating} \times \text{Resistance Value}}$

Cement Resistors

AXIAL LEAD Type

Standard Style [SQP Series]

Non-Inductive Style [NSP Series]



INTRODUCTION

- The materials used and the construction techniques ensure excellent flame resistance, arc resistance and moisture resistances as well as self-extinguishing capabilities. They will withstand the most rigorous loading test
- As resistors in radio and television receivers, the hazardous conditions of smoking and redheat can be completely prevented by the proper choice of power resistors

FEATURES

Exceptionally Small and Sturdy; Mechanically Safe. Excellent Electrical Characteristics

Resistance Tolerance: $\pm 5\%$

Applicable Specifications: EIA RS-344 and EIA RC-649

DERATING CURVE

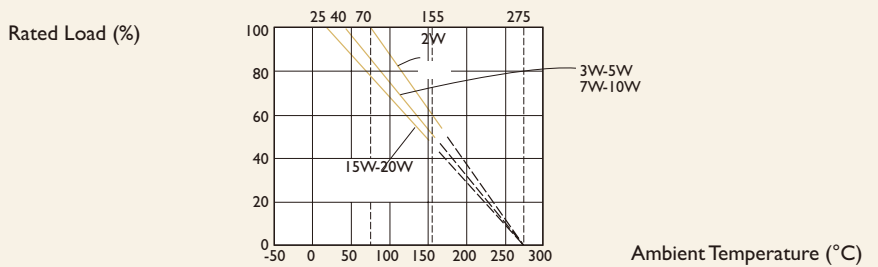

TEMPERATURE RISE

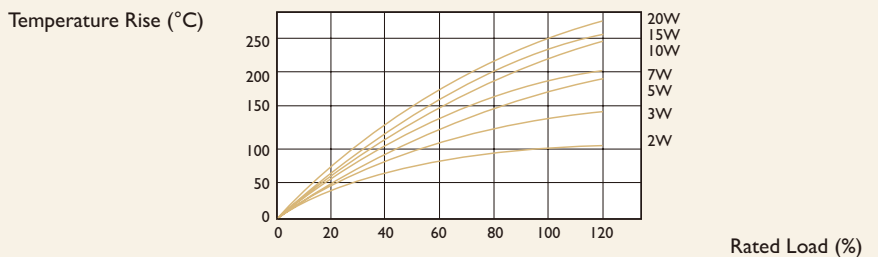

DIMENSIONS

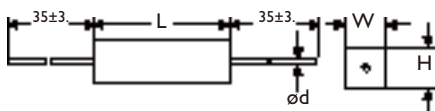

Unit : mm

STYLE		DIMENSION			
STD	Non-Ind.	L	W	H	ød
SQP200	NSP200	18±1.0	6.5±1.0	6.5±1.0	0.8±0.05
SQP300	NSP300	22±1.5	8.0±1.0	8.0±1.0	0.8±0.05
SQP500	NSP500	22±1.5	9.5±1.0	9.0±1.0	0.8±0.05
SQP700	NSP700	35±1.5	9.5±1.0	9.0±1.0	0.8±0.05
SQP10A	NSP10A	48±1.5	9.5±1.0	9.0±1.0	0.8±0.05
SQP15A	NSP15A	48±1.5	12.5±1.5	12.5±1.5	1.0±0.05
SQP20A	NSP20A	60±2.0	12.5±1.5	12.5±1.5	1.0±0.05



Note :

ELECTRICAL CHARACTERISTICS

STYLE	SQP200	SQP300	SQP500	SQP700	SQP10A	SQP15A	SQP20A
Power Rating	2W	3W	5W	7W	10W	15W	20W
Operating Temp. Range	-55°C to +155°C						
Maximum Working Voltage	250V	350V	350V	500V	500V	500V	500V
Maximum Overload Voltage	500V	700V	700V	1000V	1000V	1000V	1000V
Dielectric Withstanding Voltage	500V	700V	700V	1000V	1000V	1000V	1000V
Value Range ±5% (Wirewound)	0.15Ω~100Ω	0.3Ω~120Ω	0.3Ω~180Ω	0.5Ω~220Ω	1Ω~270Ω		
Value Range ±5% (Metal Oxide Film)	110Ω~10KΩ	130Ω~22KΩ	200Ω~33KΩ	240Ω~10KΩ	300Ω~10KΩ		
Temperature Coefficient	±300ppm/°C						

* 1. Standard resistance is as the above list, below or over this resistance on request.

* 2. Non-Inductive type up to 50Ω only.

ENVIRONMENTAL CHARACTERISTICS

PERFORMANCE TEST	TEST METHOD		APPRAISE
Short Time Overload	JIS-C-5202 5.5	2.5 Times RCWV for 5 Seconds	±(2%+0.05Ω)
Dielectric Withstanding Voltage	JIS-C-5202 5.7	in V-Block for 60 Seconds	by Type
Temperature Coefficient of Resistance	JIS-C-5202 5.2	-55°C to +155°C	±300ppm/°C
Insulation Resistance	JIS-C-5202 5.6	in V-Block	>100MΩ
Solderability	JIS-C-5202 6.5	235±5°C for 5±0.5 Seconds	95% Min. Coverage
Resistance to Solvent	JIS-C-5202 6.9	IPA for 1 Min. with Ultrasonic	No Deterioration of Coatings and Markings
Terminal Strength	Direct Load for 10 Sec. in The Direction of The Terminal Leads		≥2.5kg (24.5N)
Pulse Overload	JIS-C-5202 5.8	4 Times RCWV 10000 Cycles (1 Sec. on , 25 Sec. off)	±(2%+0.05Ω)
Load Life in Humidity	JIS-C-5202 7.9	40±2°C, 90~95% RH at RCWV for 1000 Hrs. (1.5 Hrs. on , 0.5 Hrs. off)	±(5%+0.05Ω)
Load Life	JIS-C-5202 7.10	70°C at RCWV for 1000 Hrs. (1.5 Hrs. on , 0.5 Hrs. off)	±(5%+0.05Ω)
Temperature Cycling	JIS-C-5202 7.4	-55°C→Room Temp.→+155°C→Room Temp. for 5 Cycles	±(2%+0.05Ω)
Resistance to Soldering Heat	JIS-C-5202 6.4	350°C±10°C for 3±0.5 Seconds	±(1%+0.05Ω)

* Rated Continuous Working Voltage (RCWV)= $\sqrt{\text{Power Rating} \times \text{Resistance Value}}$

Cement Resistors

VERTICAL LEAD Type

Standard Style [SQM Series]

Non-Inductive Style [NSM Series]



INTRODUCTION

- The materials used and the construction techniques ensure excellent flame resistance, arc resistance and moisture resistances as well as self-extinguishing capabilities. They will withstand the most rigorous loading test
- As resistors in radio and television receivers, the hazardous conditions of smoking and redheat can be completely prevented by the proper choice of power resistors

FEATURES

Space Saving Stand-Off Type

Small Size, High Power Capacity

Resistance Tolerance: $\pm 5\%$

Completely Unflamable

DERATING CURVE

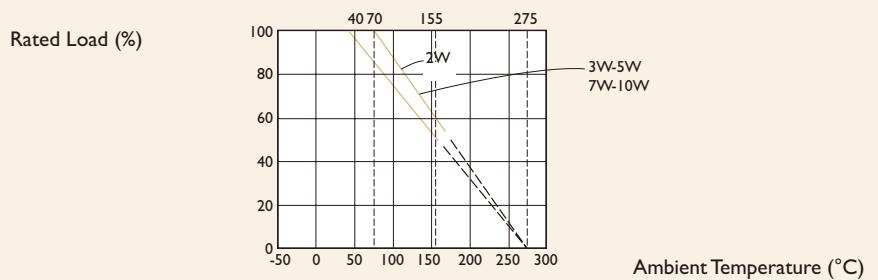

TEMPERATURE RISE

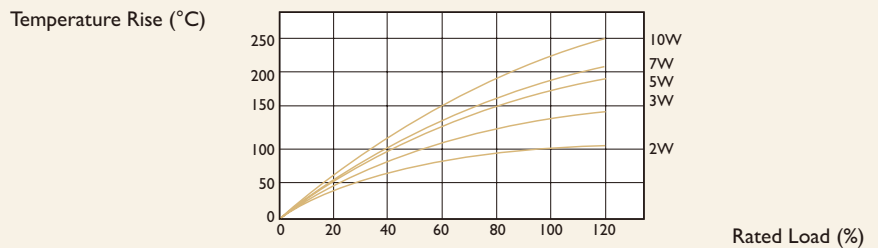

Unit : mm

DIMENSIONS

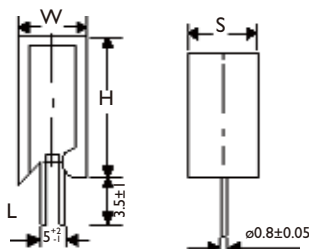

STYLE		DIMENSION		
STD	Non-Ind.	H	W	S
SQM200	NSM200	20 \pm 1.5	11.0 \pm 1.0	7.0 \pm 1.0
SQM300	NSM300	25 \pm 1.5	12.0 \pm 1.0	8.0 \pm 1.0
SQM500	NSM500	25 \pm 1.5	13.0 \pm 1.0	9.0 \pm 1.0
SQM700	NSM700	39 \pm 1.5	13.0 \pm 1.0	9.0 \pm 1.0
SQM10A	NSM10A	51 \pm 1.5	13.0 \pm 1.0	9.0 \pm 1.0
SQM10S	NSM10S	35 \pm 1.5	16.0 \pm 1.0	12.0 \pm 1.0



Note :

ELECTRICAL CHARACTERISTICS

STYLE	SQM200	SQM300	SQM500	SQM700	SQM10A	SQM10S
Power Rating	2W	3W	5W	7W	10W	
Operating Temp. Range	-55°C to +155°C					
Maximum Working Voltage	250V	350V	350V	500V	500V	500V
Maximum Overload Voltage	500V	700V	700V	1000V	1000V	1000V
Dielectric Withstanding Voltage	500V	700V	700V	1000V	1000V	1000V
Value Range ±5% (Ceramic Core)	0.15Ω~100Ω	0.24Ω~120Ω	0.3Ω~180Ω	0.51Ω~220Ω	1Ω~270Ω	
Value Range ±5% (Metal Oxide Film)	110Ω~10KΩ	130Ω~22KΩ	200Ω~33KΩ	240Ω~10KΩ	300Ω~10KΩ	
Temperature Coefficient	±300ppm/°C					

* 1. Standard resistance is as the above list, below or over this resistance on request.

* 2. Non-Inductive type up to 50Ω only.

ENVIRONMENTAL CHARACTERISTICS

PERFORMANCE TEST	TEST METHOD		APPRAISE
Short Time Overload	JIS-C-5202 5.5	2.5 Times RCWV for 5 Seconds	±(2%+0.05Ω)
Dielectric Withstanding Voltage	JIS-C-5202 5.7	in V-Block for 60 Seconds	by Type
Temperature Coefficient of Resistance	JIS-C-5202 5.2	-55°C to +155°C	±300ppm/°C
Insulation Resistance	JIS-C-5202 5.6	in V-Block	>100MΩ
Solderability	JIS-C-5202 6.5	235±5°C for 5±0.5 Seconds	95% Min. Coverage
Resistance to Solvent	JIS-C-5202 6.9	IPA for 1 Min. with Ultrasonic	No Deterioration of Coatings and Markings
Terminal Strength	Direct Load for 10 Sec. in The Direction of The Terminal Leads		≥2.5kg (24.5N)
Pulse Overload	JIS-C-5202 5.8	4 Times RCWV 10000 Cycles (1 Sec. on , 25 Sec. off)	±(2%+0.05Ω)
Load Life in Humidity	JIS-C-5202 7.9	40±2°C, 90~95% RH at RCWV for 1000 Hrs. (1.5 Hrs. on , 0.5 Hrs. off)	±(5%+0.05Ω)
Load Life	JIS-C-5202 7.10	70°C at RCWV for 1000 Hrs. (1.5 Hrs. on , 0.5 Hrs. off)	±(5%+0.05Ω)
Temperature Cycling	JIS-C-5202 7.4	-55°C→Room Temp.→+155°C→Room Temp. for 5 Cycles	±(2%+0.05Ω)
Resistance to Soldering Heat	JIS-C-5202 6.4	350°C±10°C for 3±0.5 Seconds	±(1%+0.05Ω)

* Rated Continuous Working Voltage (RCWV)= $\sqrt{\text{Power Rating} \times \text{Resistance Value}}$

Cement Resistors

RADIAL TERMINALS Type

Standard Style [SQZ Series]

Non-Inductive Style [NSZ Series]



INTRODUCTION

- The materials used and the construction techniques ensure excellent flame resistance arc resistance and moisture resistances as well as self-extinguishing capabilities. They will withstand the most rigorous loading test
- As resistors in radio and television receivers, the hazardous conditions of smoking and redheat can be completely prevented by the proper choice of power resistors

FEATURES

Space Saving Stand-Off Type

Resistance Tolerance: $\pm 5\%$

Completely Unflamable

DERATING CURVE

Rated Load (%)

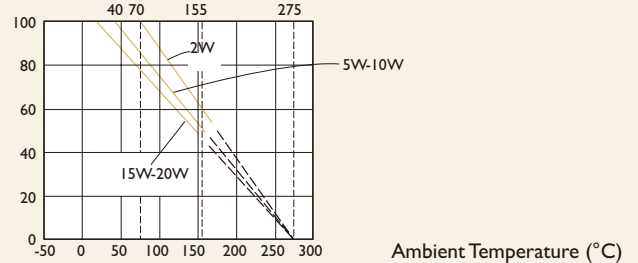

TEMPERATURE RISE

Temperature Rise (°C)

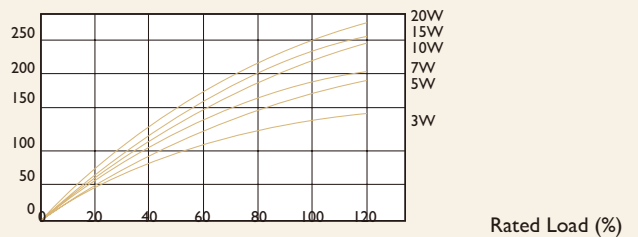

DIMENSIONS

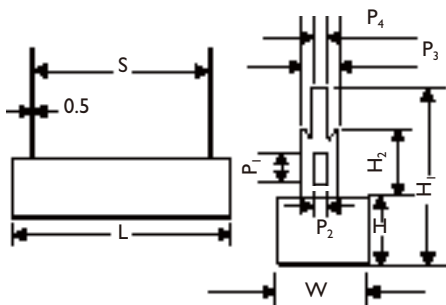

Unit : mm

STYLE	DIMENSION	DIMENSION											
		STD	Non-Ind.	L	H	W	S	H ₁	H ₂	P ₁	P ₂	P ₃	P ₄
SQZ300	NSZ300			24.0±1.5	9.0±1	9.0±1	12.5±1	24.0±1	9.5±1.0	4.0±0.2	2.0±0.2	5.0±0.2	1.4±0.1
SQZ500	NSZ500			27.0±1.5	9.5±1	9.5±1	15.0±1	24.0±1	9.5±1.0	4.0±0.2	2.0±0.2	5.0±0.2	1.4±0.1
SQZ700	NSZ700			35.0±1.5	9.5±1	9.5±1	22.5±1	24.0±1	9.5±1.0	4.0±0.2	2.0±0.2	5.0±0.2	1.4±0.1
SQZ10A	NSZ10A			48.0±1.5	9.5±1	9.5±1	32.5±1	24.0±1	9.5±1.0	4.0±0.2	2.0±0.2	5.0±0.2	1.4±0.1
SQZ15A	NSZ15A			48.0±1.5	12.5±1	12.5±1	32.5±1	34.5±1	15.0±1.5	7.0±0.2	6.0±0.2	10.0±0.2	2.7±0.1
SQZ20A	NSZ20A			63.5±2.0	12.5±1	12.5±1	42.5±1	34.5±1	15.0±1.5	7.0±0.2	6.0±0.2	10.0±0.2	2.7±0.1



Note :

ELECTRICAL CHARACTERISTICS

STYLE	SQZ300	SQZ500	SQZ700	SQZ10A	SQZ15A	SQZ20A
Power Rating	3W	5W	7W	10W	15W	20W
Operating Temp. Range	-55°C to +155°C					
Maximum Working Voltage	250V	350V	500V	500V	500V	500V
Maximum Overload Voltage	500V	700V	1000V	1000V	1000V	1000V
Dielectric Withstanding Voltage	500V	700V	1000V	1000V	1000V	1000V
Value Range ±5% (Ceramic Core)	0.22Ω~120Ω	0.47Ω~180Ω	0.68Ω~220Ω	1Ω~270Ω		
Value Range ±5% (Metal Oxide Film)	130Ω~22KΩ	200Ω~33KΩ	240Ω~10KΩ	300Ω~10KΩ		
Temperature Coefficient	±300ppm/°C					

* 1. Standard resistance is as the above list, below or over this resistance on request.

* 2. Non-Inductive type up to 50Ω only.

ENVIRONMENTAL CHARACTERISTICS

PERFORMANCE TEST	TEST METHOD		APPRAISE
Short Time Overload	JIS-C-5202 5.5	2.5 Times RCWV for 5 Seconds	±(2%+0.05Ω)
Dielectric Withstanding Voltage	JIS-C-5202 5.7	in V-Block for 60 Seconds	by Type
Temperature Coefficient of Resistance	JIS-C-5202 5.2	-55°C to +155°C	±300ppm/°C
Insulation Resistance	JIS-C-5202 5.6	in V-Block	>100MΩ
Solderability	JIS-C-5202 6.5	235±5°C for 5±0.5 Seconds	95% Min. Coverage
Resistance to Solvent	JIS-C-5202 6.9	IPA for 1 Min. with Ultrasonic	No Deterioration of Coatings and Markings
Terminal Strength	Direct Load for 10 Sec. in The Direction of The Terminal Leads		≥2.5kg (24.5N)
Pulse Overload	JIS-C-5202 5.8	4 Times RCWV 10000 Cycles (1 Sec. on , 25 Sec. off)	±(2%+0.05Ω)
Load Life in Humidity	JIS-C-5202 7.9	40±2°C, 90~95% RH at RCWV for 1000 Hrs. (1.5 Hrs. on , 0.5 Hrs. off)	±(5%+0.05Ω)
Load Life	JIS-C-5202 7.10	70°C at RCWV for 1000 Hrs. (1.5 Hrs. on , 0.5 Hrs. off)	±(5%+0.05Ω)
Temperature Cycling	JIS-C-5202 7.4	-55°C→Room Temp.→+155°C→Room Temp. for 5 Cycles	±(2%+0.05Ω)
Resistance to Soldering Heat	JIS-C-5202 6.4	350°C±10°C for 3±0.5 Seconds	±(1%+0.05Ω)

* Rated Continuous Working Voltage (RCWV)= $\sqrt{\text{Power Rating} \times \text{Resistance Value}}$

Cement Resistors

CLAMP MOUNTING Type

Standard Style [SQH Series]

Non-Inductive Style [NSH Series]



FEATURES

- Low Cost
- Small Size, High Power Capacity
- Resistance Tolerance: $\pm 5\%$, $\pm 10\%$
- Completely Unflamable

DERATING CURVE

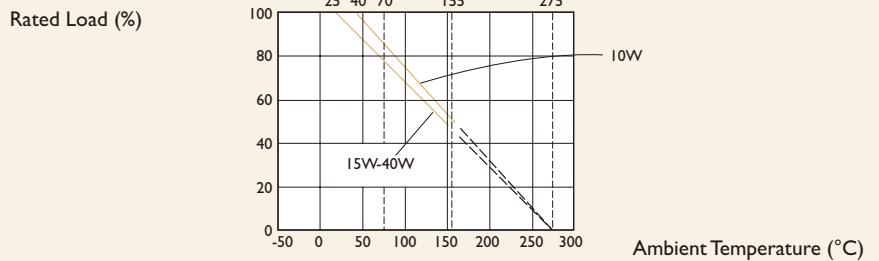

DIMENSIONS

SQH₁ Type

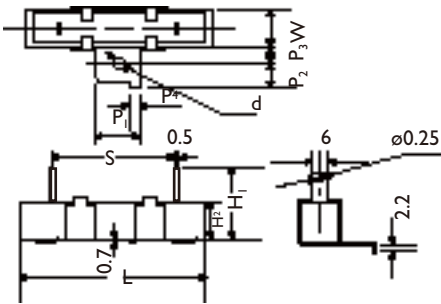

SQH₂ Type

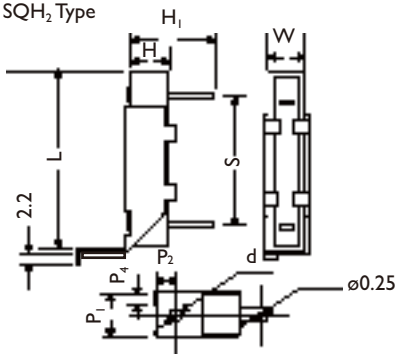

TEMPERATURE RISE

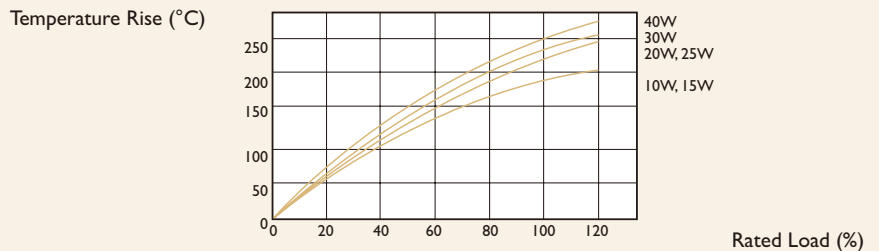

Unit : mm

STYLE		DIMENSION										
STD	Non-Ind.	L	H	W	S	H ₁	H ₂	P ₁	P ₂	P ₃	P ₄	
SQH10A	NSH10A	48.0±1.5	10.5±1.0	10.5±1	33.0±2	19.5±1.0	4.0	11.0±0.2	6.0	8.0	3.0	
SQH15A	NSH15A	48.0±1.5	12.5±1.0	12.0±1	33.0±2	20.5±1.0	4.0	11.0±0.2	6.0	8.0	3.0	
SQH20A	NSH20A	63.5±2.0	12.5±1.0	12.5±1	48.0±2	20.5±1.0	4.0	11.0±0.2	6.0	8.0	3.0	
SQH25A	NSH25A	63.5±2.0	16.0±1.0	16.0±1	46.0±2	28.0±1.5	4.2	11.0±0.2	6.0	10.0	3.0	
SQH30A	NSH30A	75.0±2.0	19.0±1.5	18.0±1	56.0±2	28.0±1.5	4.2	18.0±0.2	8.0	10.0	3.0	
SQH40A	NSH40A	90.0±2.5	19.0±1.5	18.0±1	71.0±2	28.0±1.5	4.2	18.0±0.2	8.0	10.0	3.0	



Note :

ELECTRICAL CHARACTERISTICS

STYLE	SQH10A	SQH15A	SQH20A	SQH25A	SQH30A	SQH40A
Power Rating	10W	15W	20W	25W	30W	40W
Operating Temp. Range	-55°C to +155°C					
Maximum Working Voltage	250V	350V	500V	500V	500V	500V
Maximum Overload Voltage	500V	700V	1000V	1000V	1000V	1000V
Dielectric Withstanding Voltage	1000V	1000V	1000V	1000V	1000V	1000V
Value Range ±5% (Ceramic Core)	0.39Ω~270Ω	0.39Ω~300Ω	0.51Ω~300Ω	0.51Ω~1KΩ	0.62Ω~1KΩ	0.62Ω~1KΩ
Value Range ±5% (Metal Oxide Film)	300Ω~10KΩ	330Ω~10KΩ				
Temperature Coefficient	±300ppm/°C					

* 1. Standard resistance is as the above list, below or over this resistance on request.

* 2. Non-Inductive type up to 50Ω only.

ENVIRONMENTAL CHARACTERISTICS

PERFORMANCE TEST	TEST METHOD		APPRAISE
Short Time Overload	JIS-C-5202 5.5	2.5 Times RCWV for 5 Seconds	±(2%+0.05Ω)
Dielectric Withstanding Voltage	JIS-C-5202 5.7	in V-Block for 60 Seconds	by Type
Temperature Coefficient of Resistance	JIS-C-5202 5.2	-55°C to +155°C	±300ppm/°C
Insulation Resistance	JIS-C-5202 5.6	in V-Block	>100MΩ
Solderability	JIS-C-5202 6.5	235±5°C for 5±0.5 Seconds	95% Min. Coverage
Resistance to Solvent	JIS-C-5202 6.9	IPA for 1 Min. with Ultrasonic	No Deterioration of Coatings and Markings
Terminal Strength	Direct Load for 10 Sec. in The Direction of The Terminal Leads		≥2.5kg (24.5N)
Pulse Overload	JIS-C-5202 5.8	4 Times RCWV 10000 Cycles (1 Sec. on , 25 Sec. off)	±(2%+0.05Ω)
Load Life in Humidity	JIS-C-5202 7.9	40±2°C, 90~95% RH at RCWV for 1000 Hrs. (1.5 Hrs. on , 0.5 Hrs. off)	±(5%+0.05Ω)
Load Life	JIS-C-5202 7.10	70°C at RCWV for 1000 Hrs. (1.5 Hrs. on , 0.5 Hrs. off)	±(5%+0.05Ω)
Temperature Cycling	JIS-C-5202 7.4	-55°C→Room Temp.→+155°C→Room Temp. for 5 Cycles	±(2%+0.05Ω)
Resistance to Soldering Heat	JIS-C-5202 6.4	350°C±10°C for 3±0.5 Seconds	±(1%+0.05Ω)

* Rated Continuous Working Voltage (RCWV)= $\sqrt{\text{Power Rating} \times \text{Resistance Value}}$

High Voltage Resistors

HVR Type

High Voltage Style [HVR Series]



INTRODUCTION

The HVR Series High Voltage Resistors are manufactured using vacuum sputtering system to deposit multiple layers of Metal Glaze and passive materials onto a carefully treated high grade ceramic substrate, the resistors are coated with layers of grey lacquer.

FEATURES

Power Rating : 1/6W, 1/4W, 1/2W, 1W, 2W

Resistance Tolerance : $\pm 5\%$

T.C.R: $\pm 200\text{ppm}/^\circ\text{C}$

DERATING CURVE

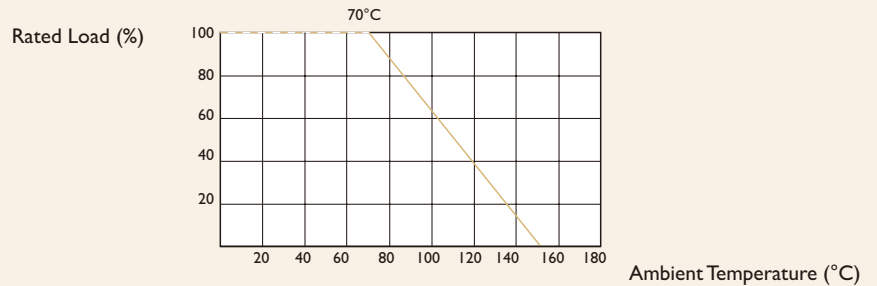

HOT-SPOT TEMPERATURE

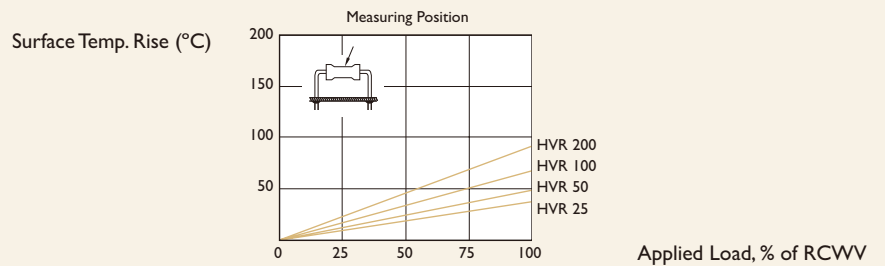

DIMENSIONS

Unit : mm

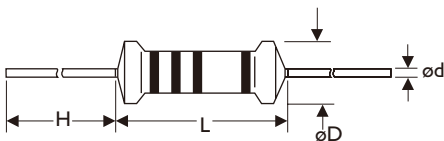

STYLE	DIMENSION			
	L	øD	H	ød
HVR-25	6.3 \pm 0.5	2.4 \pm 0.3	28 \pm 2.0	0.6 \pm 0.05
HVR-50	9.0 \pm 0.5	3.3 \pm 0.3	26 \pm 2.0	0.6 \pm 0.05
HVR100	11.5 \pm 1.0	4.5 \pm 0.5	35 \pm 2.0	0.8 \pm 0.05
HVR200	15.5 \pm 1.0	5.0 \pm 0.5	33 \pm 2.0	0.8 \pm 0.05



Note :

ELECTRICAL CHARACTERISTICS

STYLE	HVR-25	HVR-50	HVR100	HVR200
Power Rating at 70°C	1/4W	1/2W	1W	2W
Maximum Working Voltage	1600V	2000V	2500V	2500V
Maximum Overload Voltage	2000V	2500V	3000V	3000V
Dielectric Withstanding Voltage	700V	700V	700V	700V
Open Temp. Range	-55°C to +155°C			
Tolerance Range	±1%, ±5%			
Standard Value Range	100K~10MΩ for E24 series value			
Temperature Coefficient	±200 ppm /°C			

Resistance range for standard resistance, below or over this resistance on request

ENVIRONMENTAL CHARACTERISTICS

PERFORMANCE TEST	TEST METHOD		APPRAISE
Short Time Overload	JIS-C-5202 5.5	2.5 Times RCWV for 5 Seconds	±(2%+0.05Ω)
Dielectric Withstanding Voltage	JIS-C-5202 5.7	in V-Block for 60 Seconds	by Type
Temperature Coefficient of Resistance	JIS-C-5202 5.2	-55°C to +155°C	by Type
Insulation Resistance	JIS-C-5202 5.6	in V-Block	>10000MΩ
Solderability	JIS-C-5202 6.5	235±5°C for 5±0.5 Seconds	95% Min. Coverage
Resistance to Solvent	JIS-C-5202 6.9	IPA for 1 Min. with Ultrasonic	No Deterioration of Coatings and Markings
Terminal Strength	Direct Load for 10 Sec. in The Direction of The Terminal Leads		≥2.5kg (24.5N)
Pulse Overload	JIS-C-5202 5.8	4 Times RCWV 10000 Cycles (1 Sec. on , 25 Sec. off)	±(1%+0.05Ω)
Load Life in Humidity	JIS-C-5202 7.9	40±2°C, 90~95% RH at RCWV for 1000 Hrs. (1.5 Hrs. on , 0.5 Hrs. off)	±(5.0%+0.05Ω)
Load Life	JIS-C-5202 7.10	70°C at RCWV for 1000 Hrs. (1.5 Hrs. on , 0.5 Hrs. off)	±(5.0%+0.05Ω)
Temperature Cycling	JIS-C-5202 7.4	-55°C→Room Temp.→+155°C→Room Temp. for 5 Cycles	±(1.0%+0.05Ω)
Resistance to Soldering Heat	JIS-C-5202 6.4	350°C±10°C for 3±0.5 Seconds	±(1.0%+0.05Ω)

* Rated Continuous Working Voltage (RCWV)= $\sqrt{\text{Power Rating} \times \text{Resistance Value}}$



Note :

PACKING METHODS

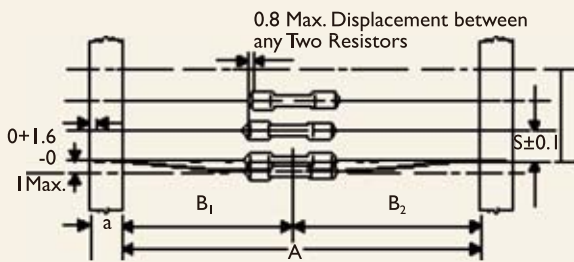

Bandolier for Axial Leads

The resistors are supplied on bandolier; either 1000 resistors in amopack or 5000 resistors on reel.

Unit : mm

STYLE		DIMENSIONS				
Normal	Miniature	a	A	B1-B2	S (Spacing)	T (Max. Deviation of Spacing)
TYPE-12	TYPE25S/204	6±0.5	52.4±1.5 26.0±1.5	1.2	5	
TYPE-25	TYPE50S/207	6±0.5	52.4±1.5 26.0±1.5	1.2 1.0	5	
TYPE-50	TYPE1WS	6±0.5	52.4±1.5	1.2	5	1mm Per 10 Spacings, 0.5mm Per 5 Spacings
TYPE100	TYPE2WS	6±0.5	73.0±1.5 52.4±1.5	1.5	5	
TYPE200	TYPE3WS	6±0.5	73.0±1.5	1.5	10	
KNP300	KNP5WS		52.4±1.5			
RSF300	RSF5WS	6±0.5	91.0±1.5	1.5	10	
RSF500/KNP500	KNP7WS		73.0±1.5			

TAPE ON REEL PACKING

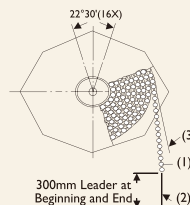

Bandoliers can be reeled;
dimension **a** differ with type.

- (1) Resistor
- (2) Bandolier
- (3) Paper
- (4) Flange
- (5) Cylinder

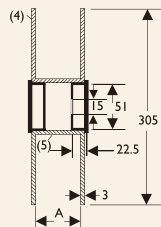

TAPE ON BOX PACKING

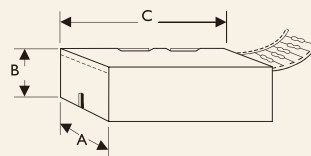

Bandoliers may also be supplied
in a cardboard box ("ammo-
pack").

"Ammopack" is an abbreviation of "ammunition packing".
The dimensions of A-B-C vary with type and quantity.

Unit : mm/pcs

STYLE		TAPE ON REEL		
Normal	Miniature	Across Flange (A)	QTY Per Reel	
TYPE-12	TYPE25S/204	72	5,000	
TYPE-25	TYPE50S/207	48/72	5,000	
TYPE-50	TYPE1WS	72	2,500	
TYPE100	TYPE2WS	95	2,000	
TYPE200	TYPE3WS	95	1,000	
KNP300	KNP5WS	95	1,000	
RSF300/500	KNP500	RSF5WS/KNP7WS	95	250

TAPE ON BOX			
W (A)	H (B)	L (C)	QTY Per Box
78/81	24/70	260	2,000/5,000
78/81	24/104	260	1,000/5,000
73	45	258	1,000
103	78	260	1,000
103	94	260	1,000
103	78	260	500
116	79	255	250



Note :

SPECIAL TYPE (FORMING DIMENSIONS)

M TYPE

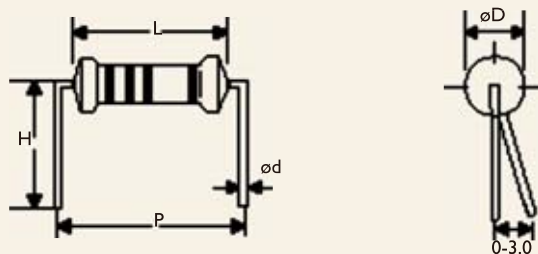

Unit : mm

STYLE	DIMENSIONS						
Normal	Miniature	L	P	ϕD	ϕd	H	
TYPE-12	TYPE25S	3.4 ± 0.3	6.0 ± 1	1.9 ± 0.2	0.5 ± 0.05	10.0 ± 1	
TYPE-25	TYPE50S	6.3 ± 0.5	10.0 ± 1	2.4 ± 0.2	0.6 ± 0.05	10.0 ± 1	
TYPE-50	TYPE1WS	9.0 ± 0.5	12.5 ± 1	3.3 ± 0.3	0.6 ± 0.05	10.0 ± 1	
TYPE100	TYPE2WS	11.5 ± 1.0	15.0 ± 1	4.5 ± 0.5	0.8 ± 0.05	12.5 ± 1	
TYPE200	TYPE3WS	15.5 ± 1.0	20.0 ± 1	5.0 ± 0.5	0.8 ± 0.05	15.0 ± 1	

MB TYPE

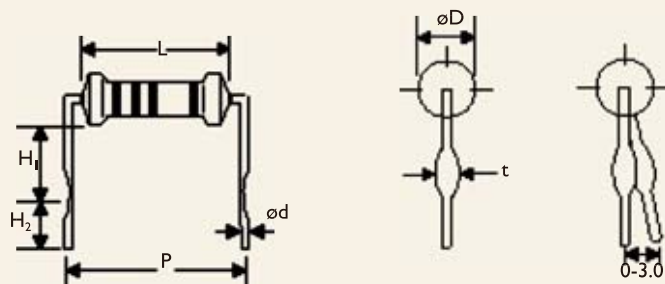

Unit : mm

STYLE	Miniature	DIMENSIONS						
Normal	Miniature	L	P	ϕD	ϕd	H1	H2	t
TYPE-25	TYPE50S	6.3 ± 0.5	10.0 ± 1	2.4 ± 0.2	0.6 ± 0.05	6.0 ± 1	5.0 ± 1	1.2 ± 0.2
TYPE-50	-	9.0 ± 0.5	12.5 ± 1	3.3 ± 0.3	0.6 ± 0.05	6.0 ± 1	5.0 ± 1	1.2 ± 0.2
-	TYPE1WS	9.0 ± 0.5	12.5 ± 1	3.3 ± 0.3	0.8 ± 0.05	6.0 ± 1	5.0 ± 1	1.4 ± 0.2
TYPE100	TYPE2WS	11.5 ± 1.0	15.0 ± 1	4.5 ± 0.5	0.8 ± 0.05	6.0 ± 1	5.0 ± 1	1.4 ± 0.2
TYPE200	TYPE3WS	15.5 ± 1.0	20.0 ± 1	5.0 ± 0.5	0.8 ± 0.05	10.0 ± 1	5.0 ± 1	1.4 ± 0.2
TYPE300	TYPE5WS	24.5 ± 1.0	30.0 ± 1	8.0 ± 0.5	0.8 ± 0.05	15.0 ± 1	5.0 ± 1	1.4 ± 0.2
TYPE500	-	24.5 ± 1.0	30.0 ± 1	8.0 ± 0.5	0.8 ± 0.05	15.0 ± 1	5.0 ± 1	1.4 ± 0.2



Note :

MR TYPE

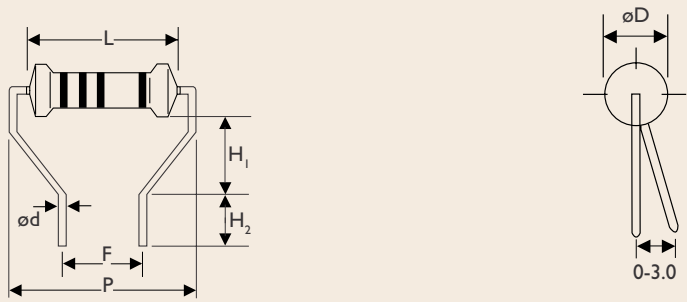

STYLE		DIMENSIONS							Unit : mm	
Normal	Miniature	L	P	F	øD	ød	H ₁	H ₂		
TYPE-50	TYPE1WS	9.0±0.5	14.5±1	7.0±0.5	3.3±0.3	0.6±0.05	7.0±1	5.0±1		
TYPE100	TYPE2WS	11.5±1.0	17.5±1	7.0±0.5	4.5±0.5	0.8±0.05	8.0±1	5.0±1		
TYPE200	TYPE3WS	15.5±1.0	21.5±1	7.0±0.5	5.0±0.5	0.8±0.05	9.0±1	5.0±1		

F TYPE

FK TYPE

FFK TYPE

FKK TYPE

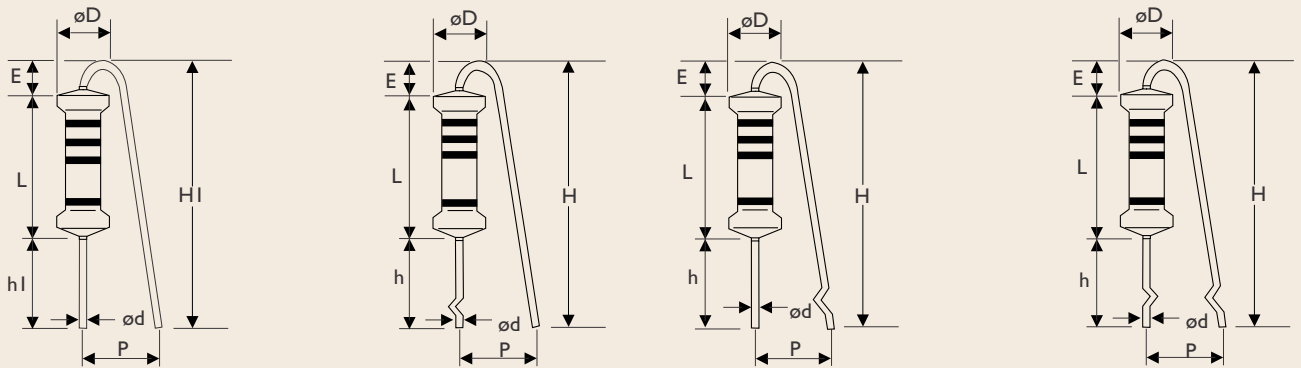

STYLE		DIMENSIONS									Unit : mm	
Normal	Miniature	L	P	øD	ød	h	H Max.	h ₁	H ₁ Max.	E Max.		
TYPE100	TYPE2WS	11.5±1	6±1	4.5±0.5	0.8±0.05	10.0±1	25	5.0±1	20	3.5		
TYPE200	TYPE3WS	15.5±1	6±1	5.0±0.5	0.8±0.05	10.0±1	30	5.0±1	25	3.5		

*TYPE-25/50S is available.



Note :

FT TYPE FORMING FOR TAPING

Rated Watts 1/4W & 1/2WS
 Body Dimension : L = 6.3±0.5mm
 øD = 2.4±0.2mm
 Rated Watts : 1/2W & 1WS
 Body Dimension : L = 9±0.5mm
 øD = 3.3±0.3mm

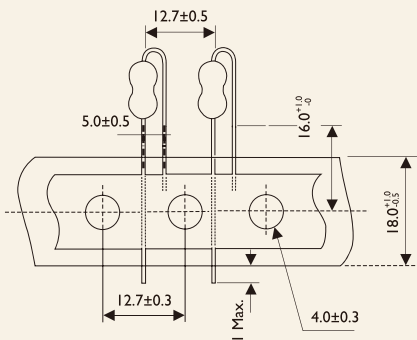

MT TYPE FORMING FOR TAPING

Rated Watts 1/6W & 1/4WS
 Body Dimension : L = 3.4±0.3mm
 øD = 1.9±0.2mm

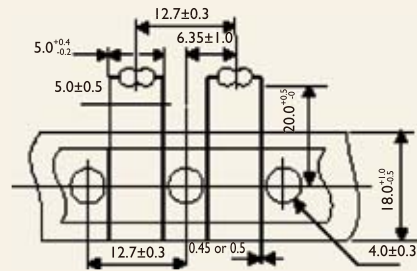

PNTYPE FORMING FOR TAPING

Rated Watts 1/4W & 1/2WS
 Body Dimension : L = 6.3±0.5mm
 øD = 2.4±0.2mm
 Rated Watts : 1/2W & 1WS
 Body Dimension : L = 9±0.5mm
 øD = 3.3±0.3mm

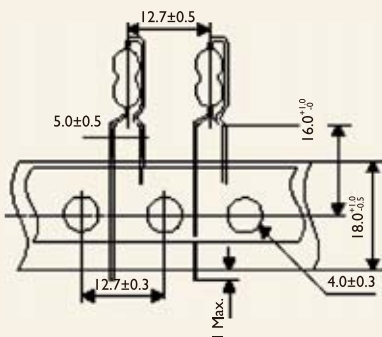

AV TYPE FORMING FOR TAPING

Rated Watts 1/4W & 1/2WS
 Body Dimension : L = 6.3±0.5mm
 øD = 2.4±0.2mm
 Rated Watts : 1/2W & 1WS
 Body Dimension : L = 9±0.5mm
 øD = 3.3±0.3mm

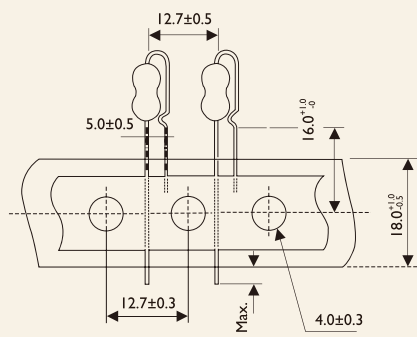



Note :

EXPLANATIONS OF ORDERING CODE

For Leaded Resistor

Explanations of Ordering Code

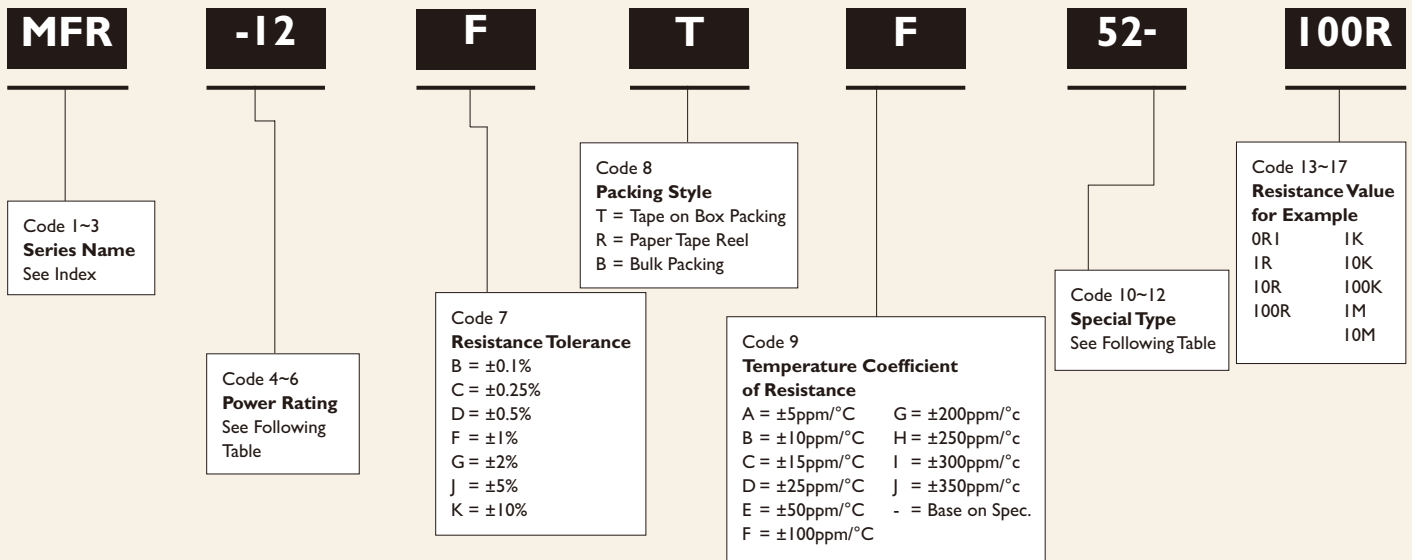

CODE 4~6

Power Rating

-12=1/6W	3WM=3WM	900=9W	90A=90W
-25=1/4W	400=4W	10A=10W	10B=100W
25S=1/4WS	4WS=4WS	10S=10WS	15B=150W
-50=1/2W	500=5W	15A=15W	20B=200W
50S=1/2WS	5WS=5WS	20A=20W	10C=1000W
100=1W	5SS=5SS	30A=30W	204=0.4W
1WS=1WS	600=6W	40A=40W	207=0.6W
200=2W	6WS=6WS	50A=50W	
2WS=2WS	700=7W	60A=60W	
300=3W	7WS=7WS	70A=70W	
3WS=3WS	800=8W	80A=80W	

CODE 10~12

Special Type

26=26mm	FKK=FKK-Type Forming for Bulk
52=52.4mm	PN=PANAsert for Taping
73=73mm	AV=AVIsert for Taping
81=81mm	MT=M-Type Forming for Taping
91=91mm	FT=F-Type Forming for Taping
M=M-Type Forming for Bulk	
MB=MB-Type Forming for Bulk	
MR=MR-Type Forming for Bulk	
F=F-Type Forming for Bulk	
FK=FK-Type Forming for Bulk	
FFK=FFK-Type Forming for Bulk	



Note :

YAGEO LEADED RESISTOR P/N FOR SYSTEM INPUT

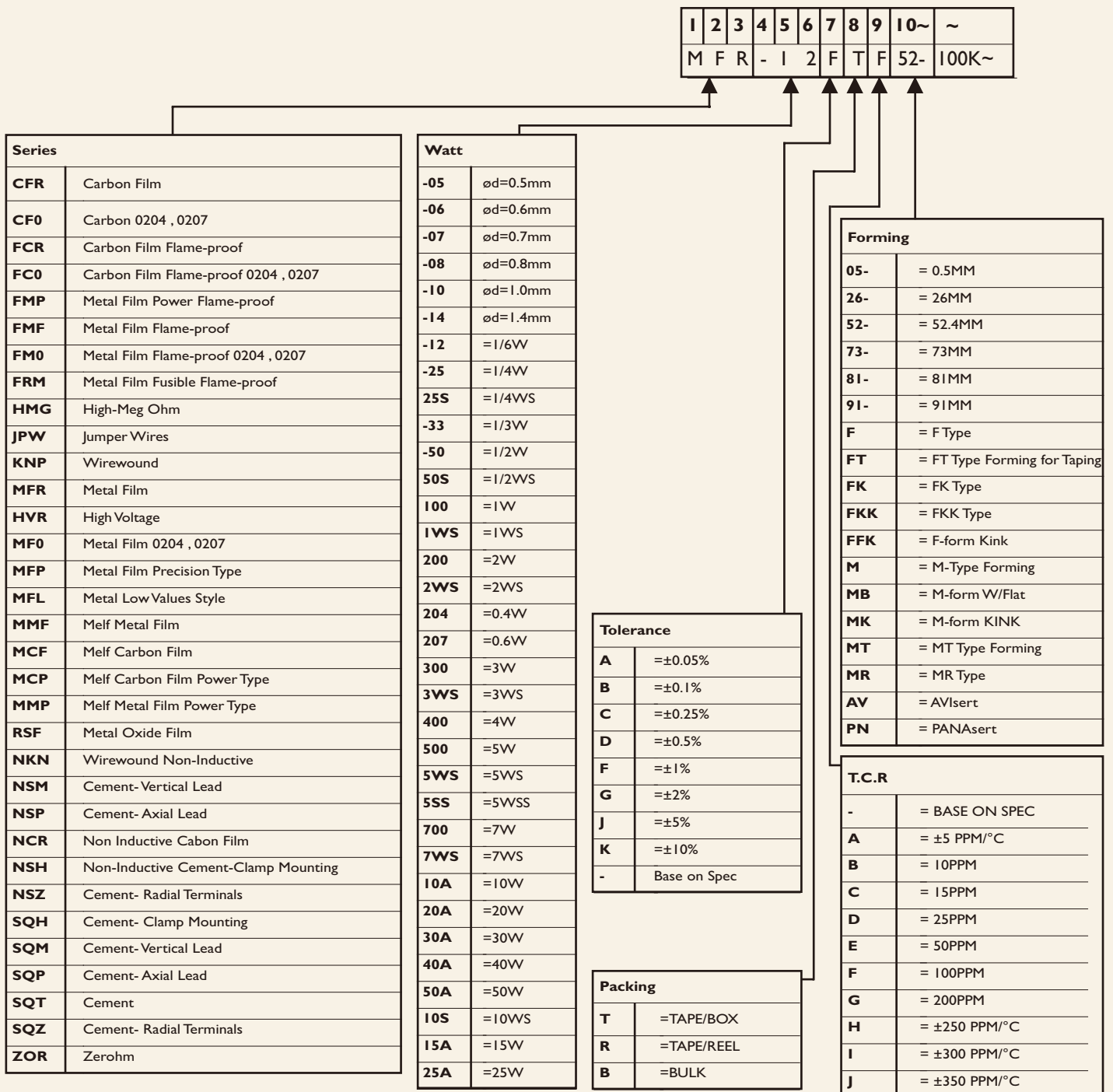



Note :

LEADED RESISTORS/KGS

POWER RATING	PCS/PER INNER BOX	BAG/PER INNER BOX	PCS/PER BAG
1/6W, 1/4WS, 0.4W	2,000	10	200
1/4W, 1/2WS, 0.6W	1,000	5	200
1/2W, 1WS	1,000	5	200
1W, 2WS	1,000	10	100
2W, 3WS	1,000	10	100
3W	500	10	50
5W	500	10	50
7W	500	10	50

LEAD TO LEAD TAPING

SIZE/POWER	RATING CODE	STANDARD LEAD LENGTH	MINIATURE LEAD LENGTH
-12	25S	52-	26-
-25	50S	52-	26-
204		52-	26-
207		52-	26-
-50	1WS	52-	N/A
100	2WS	73-	52-
200	3WS	73-	52-
	3WM	73-	52-
	5SS	73-	52-
300	5WS	91-	73-
500		91-	73-
700		91-	-

EXCEPTION

KNP/NKN	3W, 4W, 5WS	73-	52-
KNP/NKN/RSF	5W, 7W on T/R	73-	52-



Note :

LEADED RESISTORS/KGS

WATT	PACKAGE	Q'TY/PCS	WEIGHT	CTN Q'TY	NW / GW	CTN NO.	CTN SIZE / cm	CUBIC FIT
1/6W	tape/reel	5,000	1.1	50,000	11/13	E1	60 x 32 x 43	3
1/4WS	tape/box	2,000	0.3	120,000	18/20	E3	44 x 28 x 36	1.6
0.4W	tape/box	5,000	0.74	100,000	15/17	E3	44 x 28 x 36	1.6
	bulk	2,000	0.25	140,000	18/20	E3	44 x 28 x 36	1.6
1/4W	tape/reel	5,000	1.6	50,000	16/18	E1	60 x 32 x 43	3
1/2WS	tape/box	1,000	0.25	60000	15/17	E3	44 x 28 x 36	1.6
0.6W	tape/box	5,000	1.25	75,000	19/21	E3	44 x 28 x 36	1.6
	bulk	1,000	0.23	70000	16/18	E3	44 x 28 x 36	1.6
	tape/reel	2,500	1.3	25,000	13/15	E1	60 x 32 x 43	3
1/2W	tape/reel	3,000	1.6	30,000	16/18	E1	60 x 32 x 43	3
1WS	tape/box	1,000	0.43	30,000	13/15	E3	44 x 28 x 36	1.6
	bulk	1,000	0.4	40,000	16/18	E3	44 x 28 x 36	1.6
	tape/reel	2,000	2.2	20,000	22/24	E2	60 x 32 x 54.5	3.8
1W	tape/box	1,000	0.9	16,000	14/16	E3	44 x 28 x 36	1.6
2WS	bulk	1,000	0.9	16,000	14/16	E3	44 x 28 x 36	1.6
	forming	2,000	1.5	32,000	24/26	E3	44 x 28 x 36	1.6
	tape/reel	1,000	1.6	10,000	16/18	E2	60 x 32 x 54.5	3.8
2W	tape/box	1,000	1.18	12,000	14/16	E5	28 x 46 x 30	1.4
3WS	bulk	1,000	1.12	16,000	18/20	E3	44 x 28 x 36	1.6
	forming	1,000	1.02	16,000	16/18	E3	44 x 28 x 36	1.6
3W	tape/reel	500	2.2	5,000	22/24	E2	60 x 32 x 54.5	3.8
5W	tape/box	250	1.15	3,500	16/18	E3	44 x 28 x 36	1.6
5WS	bulk	500	2	4,000	16/18	E6	42.5 x 42.5 x 19	1.2
5SS	tape/box	500		10,000	18/20			1.7
	tape/reel	10,000	1.4	50,000	7/8	J2		
JPW-05	tape/Box	10,000	1.1	100,000	11/12	J1		
	tape/reel	10,000	2	50,000	10/11	J2		
JPW-06	tape/Box	10,000	1.5	100,000	15/16	J1		
	tape/reel	10,000	2.9	50,000	14/15	J2		



Note :

cement resISTORS

TYPE	WATT	BOX	CTN	NW	GW
SQP	2W	1	6	20	21
	3W	0.6	4.8	20	21
		0.5	4	18	19
	5W	0.5	4	20	21
	7W	0.25	2	18	19
	10W	0.25	2	20	21
	15W	0.15	0.9	18	19
	20W	0.1	0.6	16	17
SQM	2W	1	6	20	21
	3W	1.2	2.4	13	14
	5W	1	2	13	14
	7W	0.8	1.6	16	17
	10W	0.5	1	17	18
SQZ	5W	0.1	2	16	17
	7W	0.1	2	20	21
	10W	0.06	1.2	19	20
	15W	0.03	0.6	13	14
	20W	0.03	0.6	16	17
	40W				
SQH	10W	0.04	0.8	13	14
	15W	0.03	0.6	13	14
	20W	0.025	0.5	15	16
	40W	0.018	0.25	20	21
SQHG	20W	0.02	0.4	16	17
	30W	0.02	0.25		

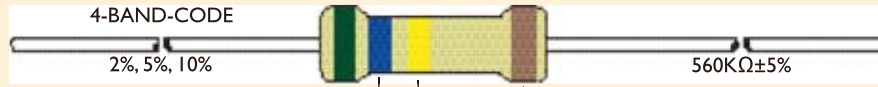

COLOR	1ST BAND	2ND BAND	3RD BAND	MULTIPLIER	TOLERANCE
BLACK	0	0	0	1Ω	
BROWN	1	1	1	10Ω	±1% (F)
RED	2	2	2	100Ω	±2% (G)
ORANGE	3	3	3	1KΩ	
YELLOW	4	4	4	10KΩ	
GREEN	5	5	5	100KΩ	±0.5% (D)
BLUE	6	6	6	1MΩ	±0.25% (C)
VIOLET	7	7	7	10MΩ	±0.10% (B)
GREY	8	8	8		±0.05%
WHITE	9	9	9		
GOLD				0.1	±5% (J)
SILVER				0.01	±10% (K)



STANDARD RESISTANCE VALUES FOR THE 10-TO-100 DECADE (Also Usable in Decade Multiples or Sub-Multiples)

RESISTANCE TOLERANCE (±%)

0.1%			0.25%			0.5%			1%			2%			5%			10%		
0.1%	0.25%	0.5%	0.1%	0.25%	0.5%	0.1%	0.25%	0.5%	0.1%	0.25%	0.5%	0.1%	0.25%	0.5%	0.1%	0.25%	0.5%	0.1%	0.25%	0.5%
10.0	10.0	10	14.7	14.7	-	21.5	21.5	-	31.6	31.6	-	46.4	46.4	-	68.1	68.1	68			
10.1	-	-	14.9	-	-	21.8	-	-	32.0	-	-	47.0	-	47	69.0	-	-			
10.2	10.2	-	15.0	15.0	15	22.1	22.1	22	32.4	32.4	-	47.5	47.5	-	69.8	69.8	-			
10.4	-	-	15.2	-	-	22.3	-	-	32.8	-	-	48.1	-	-	70.6	-	-			
10.5	10.5	-	15.4	15.4	-	22.6	22.6	-	33.2	33.2	33	48.7	48.7	-	71.5	71.5	-			
10.6	-	-	15.6	-	-	22.9	-	-	33.6	-	-	49.3	-	-	72.3	-	-			
10.7	10.7	-	15.8	15.8	-	23.2	23.2	-	34.0	34.0	-	49.9	49.9	-	73.2	73.2	-			
10.9	-	-	16.0	-	16	23.4	-	-	34.4	-	-	50.5	-	-	74.1	-	-			
11.0	11.0	11	16.2	16.2	-	23.7	23.7	-	34.8	34.8	-	51.1	51.1	51	75.0	75.0	75			
11.1	-	-	16.4	-	-	24.0	-	24	35.2	-	-	51.7	-	-	75.9	-	-			
11.3	11.3	-	16.5	16.5	-	24.3	24.3	-	35.7	35.7	-	52.3	52.3	-	76.8	76.8	-			
11.4	-	-	16.7	-	-	24.6	-	-	36.1	-	36	53.0	-	-	77.7	-	-			
11.5	11.5	-	16.9	16.9	-	24.9	24.9	-	36.5	36.5	-	53.6	53.6	-	78.7	78.7	-			
11.7	-	-	17.2	-	-	25.2	-	-	37.0	-	-	54.2	-	-	79.6	-	-			
11.8	11.8	-	17.4	17.4	-	25.5	25.5	-	37.4	37.4	-	54.9	54.9	-	80.6	80.6	-			
12.0	-	12	17.6	-	-	25.8	-	-	37.9	-	-	55.6	-	-	81.6	-	-			
12.1	12.1	-	17.8	17.8	-	26.1	26.1	-	38.3	38.3	-	56.2	56.2	56	82.5	82.5	82			
12.3	-	-	18.0	-	18	26.4	-	-	38.8	-	-	56.9	-	-	83.5	-	-			
12.4	12.4	-	18.2	18.2	-	26.7	26.7	-	39.2	39.2	39	57.6	57.6	-	84.5	84.5	-			
12.6	-	-	18.4	-	-	27.1	-	27	39.7	-	-	58.3	-	-	85.6	-	-			
12.7	12.7	-	18.7	18.7	-	27.4	27.4	-	40.2	40.2	-	59.0	59.0	-	86.6	86.6	-			
12.9	-	-	18.9	-	-	27.7	-	-	40.7	-	-	59.7	-	-	87.6	-	-			
13.0	13.0	13	19.1	19.1	-	28.0	28.0	-	41.2	41.2	-	60.4	60.4	-	88.7	88.7	-			
13.2	-	-	19.3	-	-	28.4	-	-	41.7	-	-	61.2	-	-	89.8	-	-			
13.3	13.3	-	19.6	19.6	-	28.7	28.7	-	42.2	42.2	-	61.9	61.9	62	90.9	90.9	91			
13.5	-	-	19.8	-	-	29.1	-	-	42.7	-	-	62.6	-	-	92.0	-	-			
13.7	13.7	-	20.0	20.0	20	29.4	29.4	-	43.2	43.2	43	63.4	63.4	-	93.1	93.1	-			
13.8	-	-	20.3	-	-	29.8	-	-	43.7	-	-	64.2	-	-	94.2	-	-			
14.0	14.0	-	20.5	20.5	-	30.1	30.1	30	44.2	44.2	-	64.9	64.9	-	95.3	95.3	-			
14.2	-	-	20.8	-	-	30.5	-	-	44.8	-	-	65.7	-	-	96.5	-	-			
14.3	14.3	-	21.0	21.0	-	30.9	30.9	-	45.3	45.3	-	66.5	66.5	-	97.6	97.6	-			
14.5	-	-	21.3	-	-	31.2	-	-	45.9	-	-	67.3	-	-	98.8	-	-			
E-192	E-96	E-24	E-192	E-96	E-24	E-192	E-96	E-24	E-192	E-96	E-24	E-192	E-96	E-24	E-192	E-96	E-24			