

DISTINCTIVE CHARACTERISTICS

- Nonilluminated options in 4 or 16 keys, illuminated choices in 12 or 16 keys
- 1.0mm (.039") tail pitch
- Easily integrated into designs: replaces multiple mechanical switches, soldered wires and cable assemblies
- Card insertion into design supports customized legends for nonilluminated models
- Actuating dome offers crisp, tactile feedback to positively indicate circuit transfer
- Illuminated models feature legends on embossed keypads
- Adhesive backing for easy mounting

GENERAL SPECIFICATIONS

Power Level	20mA @ 24V DC
Contact Resistance	500Ω maximum (10mA @ 10V DC)
Insulation Resistance	100 megohms minimum @ 250V DC minimum
Dielectric Strength	250V AC minimum for one minute minimum
Operational Life	1,000,000 operations minimum
Contact Timing	10 milliseconds maximum
Nominal Operating Force	1.0N ~ 6.0N
Stroke:	
Nonilluminated	.016" ~ .039" (0.4mm ~ 1.0mm)
Illuminated with Surface Sheet	.020" ~ .047" (0.5mm ~ 1.2mm)
Operating Temperature Range	-15°C ~ +50°C (+5°F ~ +122°F)

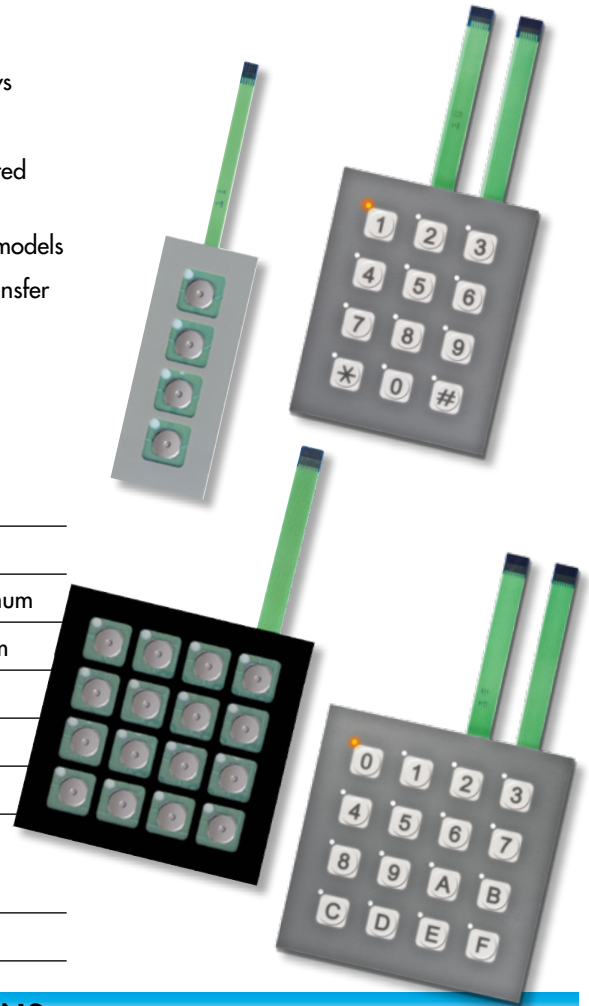

LED SPECIFICATIONS

Single Element LED Color: Amber		Unit	
Forward Voltage (Typical)	V _F	2.1	V
Forward Current (Typical)	I _F	20	mA
Forward Current (Maximum)	I _F	30	mA
* Forward Peak Current (Max)	I _{FM}	195	mA
Reverse Voltage (Maximum)	V _R	5.0	V

The electrical specifications shown are determined at a basic temperature of 25°C. LED is an integral part of the switch. LEDs are not sold separately.

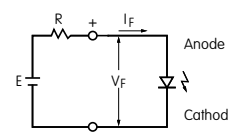

$$R = \frac{E - V_F}{I_F}$$

Where: R = Resistor Value (Ohms)
 E = Source Voltage (V)
 V_F = Forward Voltage (V)
 I_F = Forward Current (A)

LED circuits are isolated and require an external power source. If the source voltage exceeds the rated voltage, a ballast resistor is required.

* Note: Pulse width 0.1msec maximum with a maximum duty cycle ratio of 1/10

Ordering Information		Description			
Part Number	Illumination	Number of Keys	Surface Sheet		Overlay
			Black (D)	Gray (E)	
FMBN04BD	Nonilluminated	4	•		
FMBN04BE		4		•	
FMBN16BD		16	•		
FMBN16BE		16		•	
FMBP12BF	Dot Illuminated with Overlay	12			Gray Surface Sheet with Embossed White Keypad and Gray Legends
FMBP16BF		16			

TYPICAL SWITCH DIMENSIONS

Nonilluminated • 4 or 16 Keys

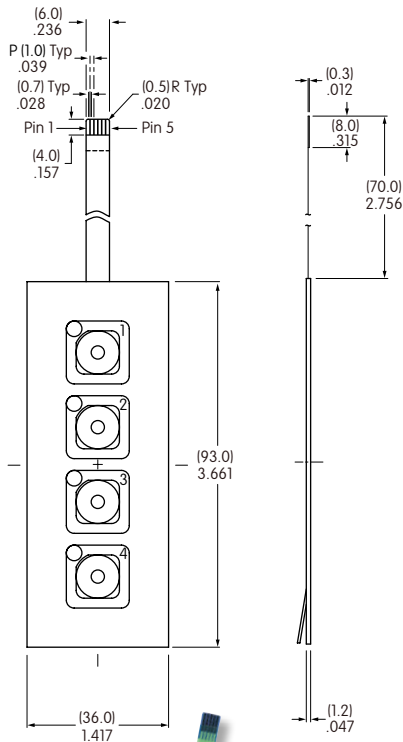

Switch Circuit Matrix For 4 Key

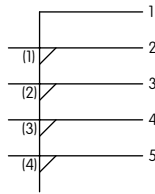

Key numbers in parenthesis are not actually on panel and are for reference only

Switch Circuit Matrix Detail For 4 or 16 Key

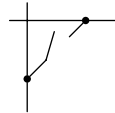

Switch Circuit Matrix For 16 Key

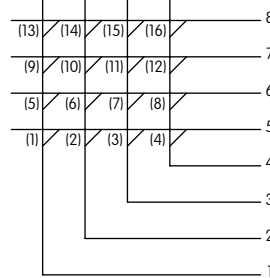

Key numbers in parenthesis are not actually on panel and are for reference only

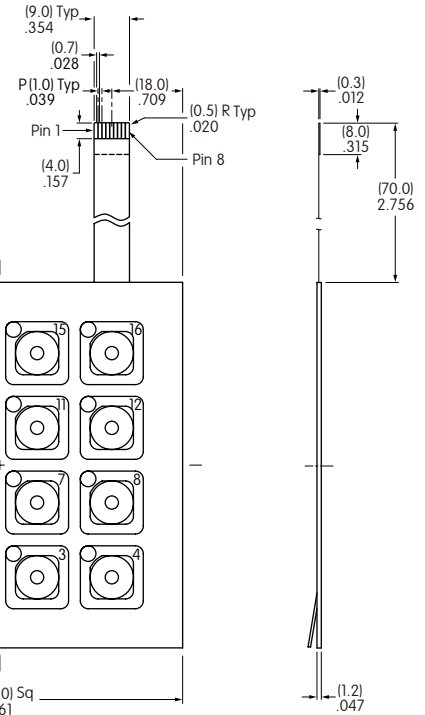

FMBN04BE
with Gray
Surface
Sheet

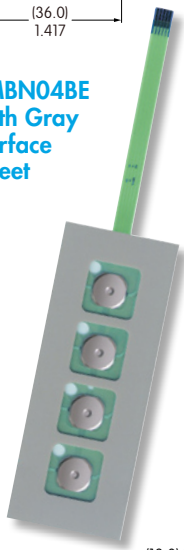

FMBN16BD
with Black
Surface
Sheet

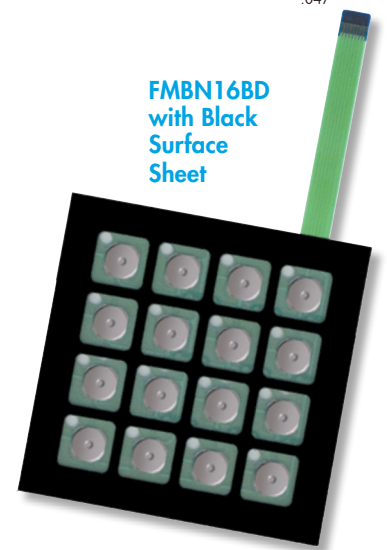

Insertable Legend Card for 4 Key or 16 Key

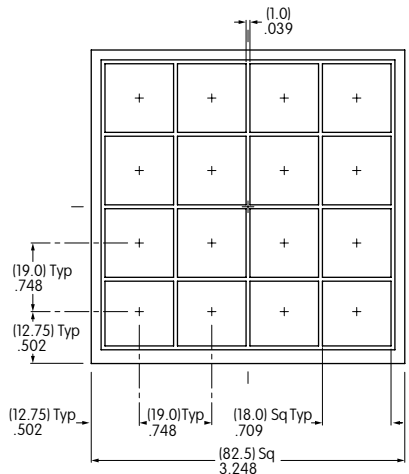
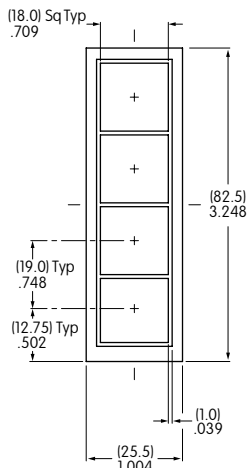

Insertable Legend Cards are supplied with the nonilluminated switch keypad assembly in Black, Gray and Yellow

TYPICAL SWITCH DIMENSIONS

Illuminated • 12 or 16 Keys

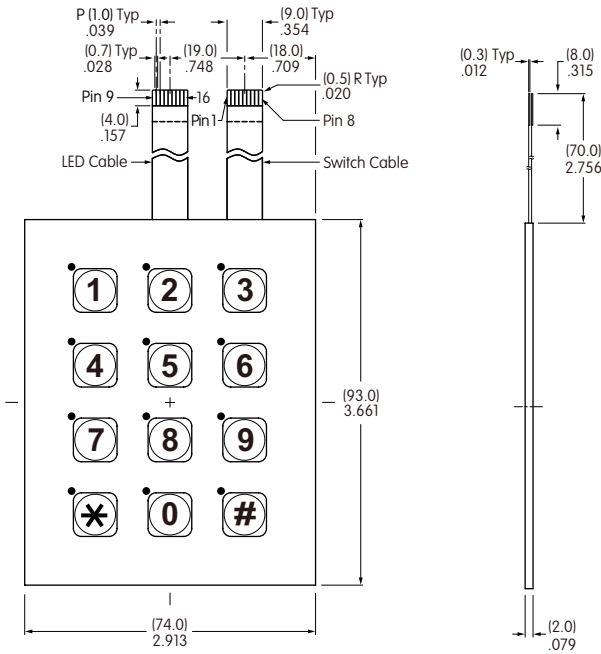

Dot illumination at upper left corner of each keypad

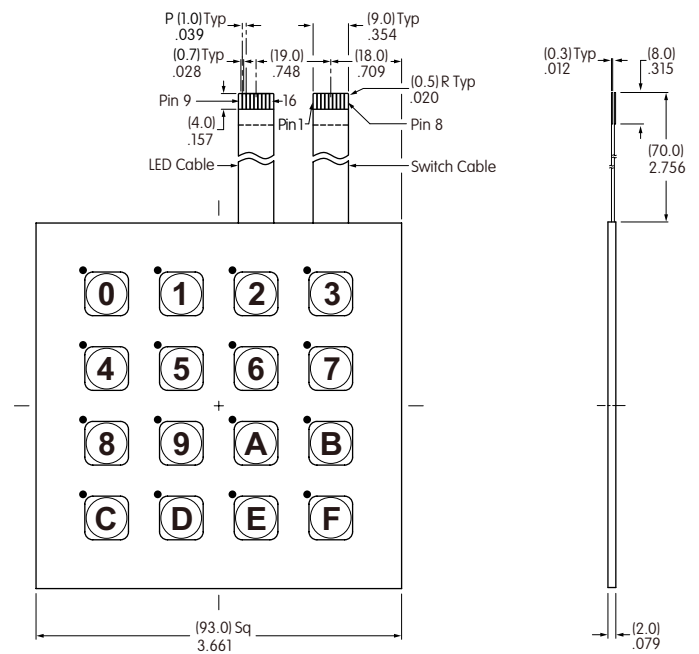

Dot illumination at upper left corner of each keypad

Switch Circuit Matrix For 12 Key

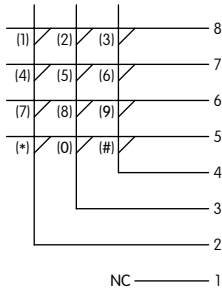

LED Circuit Matrix For 12 Key

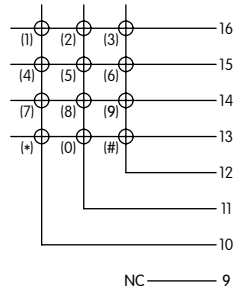

Switch Circuit Matrix For 16 Key

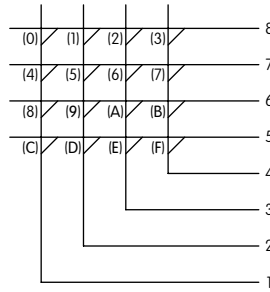

LED Circuit Matrix For 16 Key

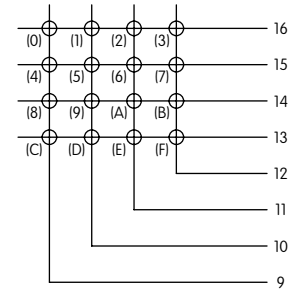

Key numbers in parenthesis are not actually on panel and are for reference only



FMBP12BF

Switch Circuit Matrix Detail For 12 or 16 Key

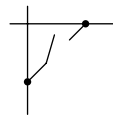

LED Circuit Matrix Detail For 12 or 16 Key

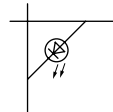

FMBP16BF

INSERTABLE LEGEND CARDS

Instructions for Customizing Insertable Legends

The membrane keypad assembly comes with three insertable legend cards: yellow, gray and black.

The following provides guidelines for creating and insertion of legend cards for the membrane switch keypad assembly. Read all of the instructions prior to customizing and inserting the legend card.

- Using the borders on the insertable legend card as a guide, be sure characters on the card are about 1.5mm (.059") within these borders. This is the printable area.
- Legend characters may be drawn, printed, etc. Be sure that application choice is completely dry before inserting into membrane keypad assembly.

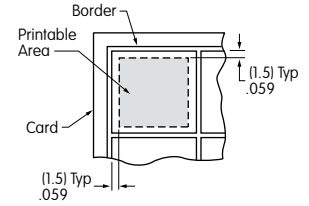

Instructions for Inserting Legend Card

- Note correct orientation of insertable legend card. Insert card under surface sheet, and use caution to avoid bending the membrane keypad assembly. Do not use pointed object to insert card, and do not remove surface sheet.
- Align and center all legend characters within the squares of the surface sheet.
- Smooth any wrinkles or air pockets from surface sheet.
- Peel off adhesive strip from the membrane keypad assembly.
- The legend card is now firmly in place and cannot be removed.
- Detach the protective film.

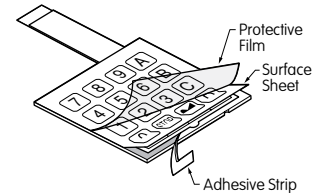
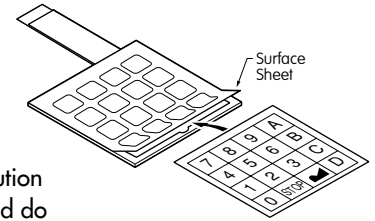

Connectors

Recommended Connectors for 5 Pin

Straight: FCI Part No. SLW5S-5C7LF
Right Angle: FCI Part No. SLW5R-5C7LF

Recommended Connectors for 8 Pin

Straight: FCI Part No. SLW8S-5C7LF
Right Angle: FCI Part No. SLW8R-5C7LF

APPLICATIONS

- Communication equipment
- Office machines
- Electronic equipment for national security
- Automation equipment
- Electronic equipment
- Amusement equipment