



### Features/Benefits

- Multi-pole and multi-position
- Shorting and non-shorting contacts available
- Low level and power capability
- PCB mounting

### Typical Applications

- Security alarm systems
- Medical equipment
- Computer servers

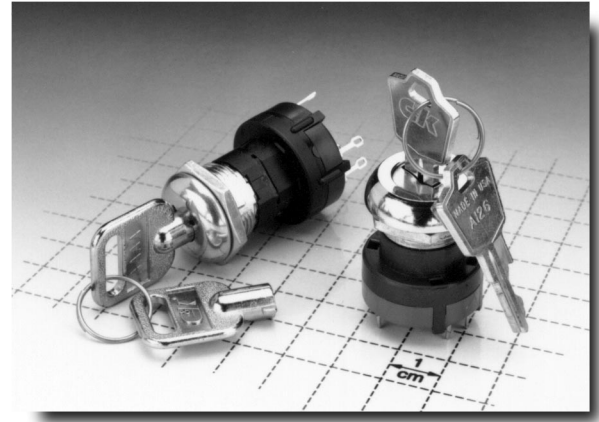

### Build-A-Switch

Our easy Build-A-Switch concept allows you to mix and match options to create the switch you need. Below is a complete listing of options shown in catalog. To order, simply select desired option from each category and place in the appropriate box. Switchlocks with standard options are shown on page H-36. Available options are shown and described on pages H-37 thru H-41. For additional options not shown in catalog, consult Customer Service Center.

Typical Example: A 2 1 6 1 3 — 2 — A — 2 — N — Z — N — Q —   —  

#### Switch and Lock Function

- A21613** (STD.) DP, 30° Index
- A2151U** (STD.) DP, 45° Index
- A11413** SP, 90° Index
- A21413** DP, 90° Index
- A31413** 3P, 90° Index
- A1141C** SP, 90° Index
- A2141C** DP, 90° Index
- A3141C** 3P, 90° Index
- A1141U** SP, 90° Index
- A2141U** DP, 90° Index
- A3141U** 3P, 90° Index
- A11513** SP, 45° Index
- A21513** DP, 45° Index
- A31513** 3P, 45° Index
- A1151C** SP, 45° Index
- A2151C** DP, 45° Index
- A3151C** 3P, 45° Index
- A1151U** SP, 45° Index
- A3151U** 3P, 45° Index
- A11582** SP, 45° Index
- A21582** DP, 45° Index
- A11613** SP, 30° Index
- A31613** 3P, 30° Index
- A1161C** SP, 30° Index
- A2161C** DP, 30° Index
- A3161C** 3P, 30° Index
- A1161U** SP, 30° Index
- A2161U** DP, 30° Index
- A3161U** 3P, 30° Index
- A11773** SP, 90° Index
- A1177C** SP, 90° Index
- A1177U** SP, 90° Index
- A12019** SP, 30° Index
- A22019** DP, 30° Index
- A32019** 3P, 30° Index
- A42019** 4P, 30° Index
- A12112** SP, 45° Index
- A22112** DP, 45° Index
- A32112** 3P, 45° Index
- A42112** 4P, 45° Index
- A12310** SP, 30° Index
- A22310** DP, 30° Index
- A32310** 3P, 30° Index
- A42310** 4P, 30° Index

#### Keying

- 2** (STD.) Two nickel plated brass keys (4 tumbler) or two die cast zinc alloy keys with chrome plating (6 tumbler)
- J** One nickel plated brass key with plastic insert molded round head and one nickel plated brass key
- T** One nickel plated brass key with plastic insert molded square head and one nickel plated brass key

#### Lock Type

- A** (STD.) 4 Tumbler lock
- W** (STD.) 6 Tumbler tubular lock with anti-static switch
- G** 5 Tumbler lock with anti-static switch
- Y** 4 Tumbler lock with anti-static switch
- B** 5 Tumbler lock

#### Lock Finish

- 2** (STD.) Stainless steel facing
- 1** Nickel plated with removable dress nut
- 4** Polished nickel with removable dress nut
- 8** Gloss black facing
- F** Polished nickel facing

#### Shorting/Non-Shorting

- N** (STD.) Non-shorting contacts
- S** Shorting contacts

#### Terminations

- Z** (STD.) Solder lug
- C** PC Thru-hole

#### Mounting/Lock Style

- N** (STD.) With nut
- D** With clip
- R** With removable dress nut

#### Contact Material

- Q** (STD.) Silver
- B** Gold
- G** Gold over silver

#### Seal

- NONE** (STD.) No seal
- E** Epoxy seal

#### Key Color

- NONE** (STD.) Nickel plated brass (4 & 5 tumbler) or chrome plated zinc alloy (6 tumbler)
- 1** White
- 2** Black
- 3** Red
- T** Beige

# A Series 4 & 5 Tumbler & 6 Tumbler 1-4 Pole Switchlocks



## Specifications

**CONTACT RATING:** Q contact material: Switch-2.5 AMPS @ 125 V AC; 350 mA @ 125 V DC (UL/CSA). Carry-5 AMPS continuous. See page H-41 for additional ratings.

**ELECTRICAL LIFE:** 15,000 make-and-break cycles at full load up to 300,000 detent operations.

**CONTACT RESISTANCE:** Below 20 milliohms typ. initial @ 2-4 V DC, 100 mA, for both silver and gold plated contacts.

**INSULATION RESISTANCE:**  $10^9$  ohms min.

**DIELECTRIC STRENGTH:** 1,000 V RMS min. @ sea level.

**OPERATING TEMPERATURE:**  $-30^{\circ}\text{C}$  to  $85^{\circ}\text{C}$ .

**INDEXING:**  $30^{\circ}$ , 2-4 positions.  $45^{\circ}$  or  $90^{\circ}$ , 2-3 positions.

**STATIC RESISTANCE:** Anti-static models exceed 20 KV DC static resistance @ sea level, lock body to terminals.

**NOTE:** Specifications and materials listed above are general specifications for switchlocks with standard options. For information on specific and custom switchlocks, consult Customer Service Center.

## Materials

**LOCK:** Zinc alloy with stainless steel facing (4 & 5 tumbler locks and 6 tumbler tubular lock).

**KEYS:** Two nickel plated brass keys with code number (4 & 5 tumbler lock). Two die cast chrome plated zinc alloy keys (6 tumbler lock).

**SWITCH HOUSING:** Glass filled 6/6 nylon (UL 94V-0).

**MOVABLE CONTACT:** Q contact material: Coin silver, silver plated. See page H-41 for additional contact materials.

**STATIONARY CONTACTS & TERMINALS:** Q contact material: Brass, silver plated. See page H-41 for additional contact materials.

**MOUNTING NUT:** Zinc alloy or steel, nickel or bright zinc plated.

**MOUNTING CLIP:** Steel, nickel or bright zinc plated.

**DRESS NUT:** Brass, nickel plated.

**LOCKING RING:** 6/6 nylon (UL 94V-2).

**TERMINAL SEAL:** Epoxy.

## SWITCHLOCKS WITH STANDARD OPTIONS

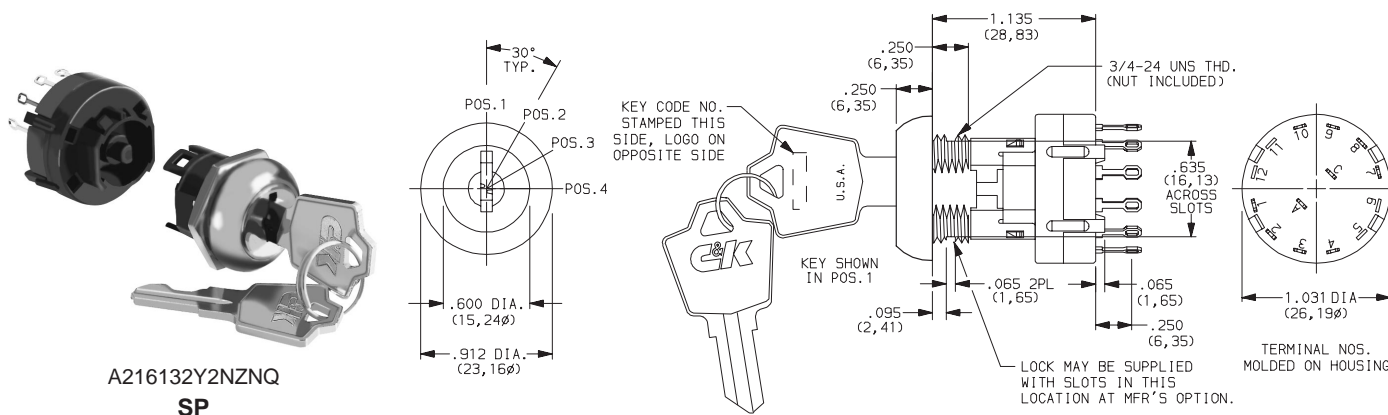

A216132Y2NZNQ  
SP

PART NUMBER	NO. TUMBLERS	INDEXING
A216132Y2NZNQ	4	$30^{\circ}$

**NOTE:** For panel mounting information, see page H-40.

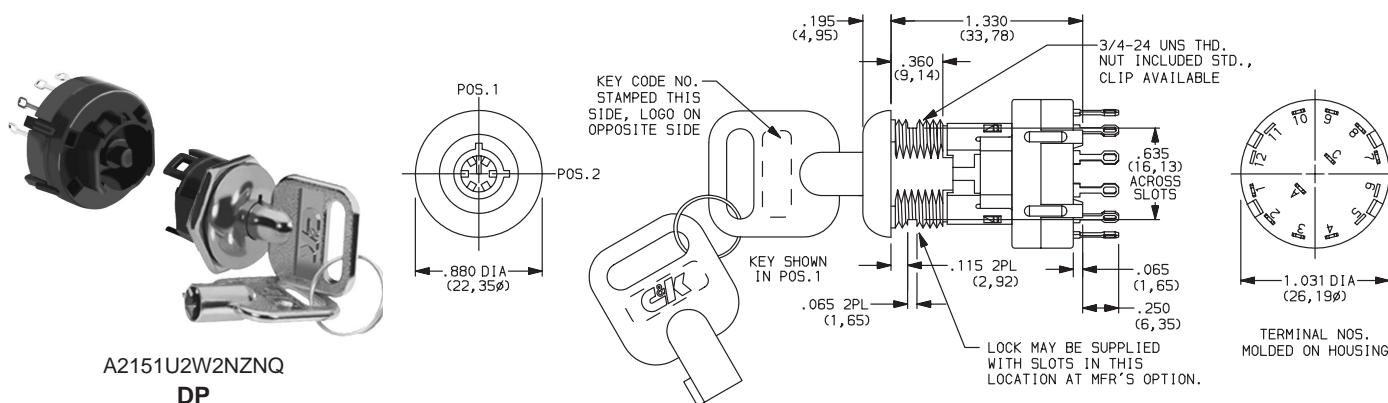

A2151U2W2NZNQ  
DP

PART NUMBER	NO. TUMBLERS	INDEXING
A2151U2W2NZNQ	6	$45^{\circ}$

**NOTE:** For panel mounting information, see page H-40.



# A Series 4, 5 & 6 Tumbler 1-4 Pole Switchlocks

## SWITCH AND LOCK FUNCTION



H

Switchlock

NO. TUMBLERS	NO. POLES	MODEL NO.	CONNECTED TERMINALS				KEY PULL POSITIONS	LOCK CONFIGURATION	INDEXING
			POS. 1	POS. 2	POS.3	POS.4			
4, 5 & 6	SP DP 3P	<b>A11413*</b> <b>A21413</b> <b>A31413</b>	A-1 A-1, C-7 A-1, B-5, C-9	A-4 A-4, C-10 A-4, B-8, C-12			Position 1		90°
4 & 5	SP DP 3P	<b>A1141C*</b> <b>A2141C</b> <b>A3141C</b>	A-1 A-1, C-7 A-1, B-5, C-9	A-4 A-4, C-10 A-4, B-8, C-12			Position 2		
4, 5 & 6	SP DP 3P	<b>A1141U*</b> <b>A2141U</b> <b>A3141U</b>	A-1 A-1, C-7 A-1, B-5, C-9	A-4 A-4, C-10 A-4, B-8, C-12			Positions 1 & 2		
4, 5 & 6	SP DP 3P	<b>A11513*</b> <b>A21513</b> <b>A31513</b>	A-1 A-1, C-7 A-1, B-5, C-9	A-2 A-2, C-8 A-2, B-6, C-10	A-4 A-4, C-10 A-4, B-8, C-12		Position 1		45°
4 & 5	SP DP 3P	<b>A1151C*</b> <b>A2151C</b> <b>A3151C</b>	A-1 A-1, C-7 A-1, B-5, C-9	A-2 A-2, C-8 A-2, B-6, C-10	A-4 A-4, C-10 A-4, B-8, C-12		Position 3		
4, 5 & 6	SP DP 3P	<b>A1151U*</b> <b>A2151U</b> <b>A3151U</b>	A-1 A-1, C-7 A-1, B-5, C-9	A-2 A-2, C-8 A-2, B-6, C-10	A-4 A-4, C-10 A-4, B-8, C-12		Positions 1 & 3		
4 & 5	SP DP	<b>A11582</b> <b>A21582</b>	A-4 A-4, C-10	A-5 A-5, C-11	A-2 A-2, C-8		Position 1		30°
4 & 5	SP DP 3P	<b>A11613*</b> <b>A21613</b> <b>A31613</b>	A-1 A-1, C-7 A-1, B-5, C-9	A-2 A-2, C-8 A-2, B-6, C-10	A-3 A-3, C-9 A-3, B-7, C-11	A-4 A-4, C-10 A-4, B-8, C-12	Position 1		
4 & 5	SP DP 3P	<b>A1161C*</b> <b>A2161C</b> <b>A3161C</b>	A-1 A-1, C-7 A-1, B-5, C-9	A-2 A-2, C-8 A-2, B-6, C-10	A-3 A-3, C-9 A-3, B-7, C-11	A-4 A-4, C-10 A-4, B-8, C-12	Position 4		
4 & 5	SP DP 3P	<b>A1161U*</b> <b>A2161U</b> <b>A3161U</b>	A-1 A-1, C-7 A-1, B-5, C-9	A-2 A-2, C-8 A-2, B-6, C-10	A-3 A-3, C-9 A-3, B-7, C-11	A-4 A-4, C-10 A-4, B-8, C-12	Positions 1 & 4		90°
4 & 5	SP	<b>A11773</b>	A-1	A-4	A-10		Position 1		

### LEGEND

- = Detent Positions (30°, 45° or 90°)
- ⊙ = Key pull possible in these positions.
- = Stop Positions

### TERMINAL NUMBERS



4P MODEL



3P MODEL

\*NOTE: Switchlock models A114XX, A115XX and A116XX with 'C' terminations have additional terminal no. 8 as switch support only. This terminal is not connected electrically inside switch.

All models with all options when ordered with 'G' or 'Q' contact material.

AX14 and AX17 models not available with 'S' shorting contacts.

SP MODEL (omit terminals B, C & D)  
DP MODEL (omit terminals B & D)

Terminal numbers molded on housing bottom.

# A Series 4 & 5 Tumbler & 6 Tumbler 1-4 Pole Switchlocks



## SWITCH AND LOCK FUNCTION

NO. TUMBLERS	NO. POLES	MODEL NO.	CONNECTED TERMINALS			KEY PULL POSITIONS	LOCK CONFIGURATION	INDEXING
			POS. 1	POS. 2	POS. 3			
4 & 5	SP	<b>A1177C</b>	A-1	A-4	A-10	Positions 2, 3		90°
4 & 5	SP	<b>A1177U</b>	A-1	A-4	A-10	Positions 1, 2 & 3		
4 & 5	SP	<b>A12019*</b>	A-1	A-2		Position 1		30°
	DP	<b>A22019</b>	A-1, C-7	A-2, C-8				
	3P	<b>A32019</b>	A-1, B-5, C-9	A-2, B-6, C-10				
	4P	<b>A42019</b>	A-1, B-4, C-7, D-10	A-2, B-5, C-8, D-11				
4 & 5	SP	<b>A12112*</b>	A-1	A-2		Position 1		45°
	DP	<b>A22112</b>	A-1, C-7	A-2, C-8				
	3P	<b>A32112</b>	A-1, B-5, C-9	A-2, B-6, C-10				
	4P	<b>A42112</b>	A-1, B-4, C-7, D-10	A-2, B-5, C-8, D-11				
4 & 5	SP	<b>A12310*</b>	A-1	A-2	A-3	Position 1		30°
	DP	<b>A22310</b>	A-1, C-7	A-2, C-8	A-3, C-9			
	3P	<b>A32310</b>	A-1, B-5, C-9	A-2, B-6, C-10	A-3, B-7, C-11			
	4P	<b>A42310</b>	A-1, B-4, C-7, D-10	A-2, B-5, C-8, D-11	A-3, B-6, C-9, D-12			

### LEGEND

- = Detent Positions (30°, 45° or 90°)
- ⊙ = Key pull possible in these positions.
- ⊙ = Stop Positions

### TERMINAL NUMBERS



4P MODEL



3P MODEL

\*NOTE: Switchlock models A12019, A12112, A12310 with 'C' terminations have additional terminal no. 8 as switch support only. This terminal is not connected electrically inside switch.

AX20 and AX23 models not available with 'G' or 'Z' lock types.

All models with all options when ordered with 'G' or 'Q' contact material.

SP MODEL (omit terminals B, C & D)  
DP MODEL (omit terminals B & D)

Terminal numbers molded on housing bottom.

### KEYING

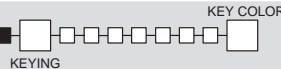

OPTION CODE	KEY OPTIONS	CODE NO. ON KEY	CODE NO. ON LOCK
<b>2</b>	(STD.) 2 NICKEL PLATED BRASS KEYS (4 & 5 TUMBLER) OR 2 DIE CAST CHROME PLATED ZINC ALLOY KEYS (6 TUMBLER)	YES	NO
<b>J</b>	1 NICKEL PLATED BRASS KEY WITH PLASTIC INSERT MOLDED ROUND HEAD & 1 NICKEL PLATED BRASS KEY	YES	NO
<b>T</b>	1 NICKEL PLATED BRASS KEY WITH PLASTIC INSERT MOLDED SQUARE HEAD & 1 NICKEL PLATED BRASS KEY	YES	NO

OPTION CODE	KEY COLOR
<b>NONE</b>	(STD.) NICKEL PLATED BRASS (4 & 5 TUMBLER) OR CHROME PLATED ZINC ALLOY (6 TUMBLER)
<b>1</b>	WHITE
<b>2</b>	BLACK
<b>3</b>	RED
<b>T</b>	BEIGE

NOTE: All orders keyed alike, standard. For more than one key code, replacement keys or other special features, consult Customer Service Center.

**NICKEL PLATED BRASS KEY**

Key part number: 115140126

**NICKEL PLATED BRASS KEY WITH PLASTIC INSERT MOLDED ROUND HEAD**

Key part number: 16564112602

**NICKEL PLATED BRASS KEY WITH PLASTIC INSERT MOLDED SQUARE HEAD**

Key part number: 11599112602

**CHROME PLATED ZINC ALLOY KEY**

Code number on opposite side of key.

Key part number: 1110801



## LOCK TYPE

**A** (STD.) 4 TUMBLER LOCK WITH REMOVABLE DRESS NUT

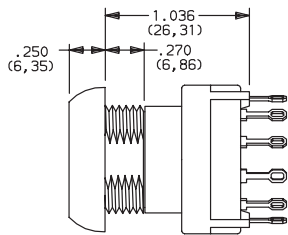

**W** (STD.) 6 TUMBLER TUBULAR LOCK WITH ANTI-STATIC SNAP-ON SWITCH

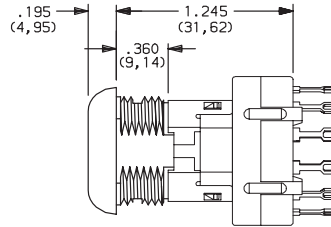

**G** 5 TUMBLER LOCK WITH ANTI-STATIC SWITCH

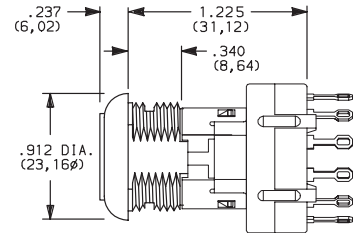

**Y** 4 TUMBLER LOCK WITH ANTI-STATIC SWITCH

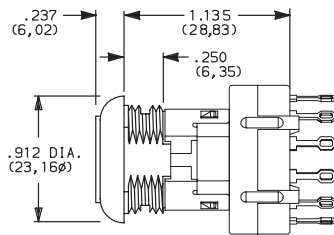

**B** 5 TUMBLER LOCK WITH REMOVABLE DRESS NUT

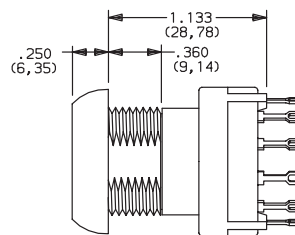

Not available with AX20 and AX23 models.

LOCK TYPES	MOUNTING STYLES		
	D	N	R
G	•	•	
A			•
W	•	•	
Y	•	•	
B			•

Not available with AX20 and AX23 models.

NOTE: For available option combinations, see page H-40.

## LOCK FINISH

**2** (STD.) STAINLESS STEEL

**1** NICKEL

**4** POLISHED NICKEL

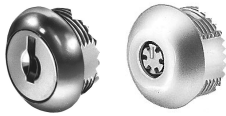

Available with W lock type only.

**8** GLOSS BLACK

**F** POLISHED NICKEL



FINISH OPTIONS	LOCK TYPES					MOUNTING STYLES		
	G	A	W	Y	B	D	N	R
1		•			•			•
2	•		•	•		•		
4		•			•			
8	•	•		•	•	•		•
F	•			•		•		

NOTE: For available option combinations, see page H-40.

## SHORTING/NON-SHORTING

**N** (STD.) NON-SHORTING CONTACTS (break-before-make)

**S** SHORTING CONTACTS (make-before-break)

Not available with AX14 and AX17 models.

## TERMINATIONS

**Z** (STD.) SOLDER LUG

**C** PC THRU-HOLE

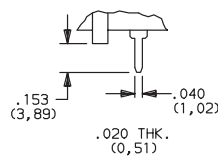
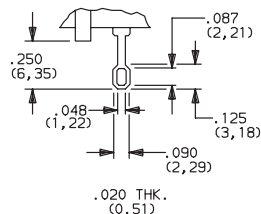

PC MOUNTING

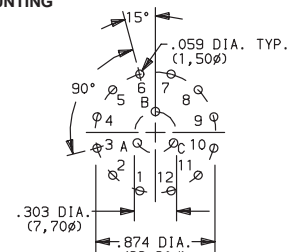
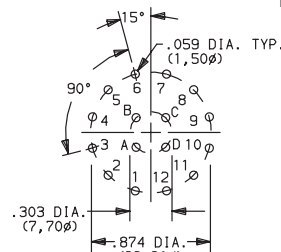

4P MODEL

3P MODEL

SP MODEL (omit terminals B, C & D)  
DP MODEL (omit terminals B & D)

# A Series 4 & 5 Tumbler & 6 Tumbler 1-4 Pole Switchlocks



## MOUNTING/LOCK STYLE

**N** (STD.) WITH NUT

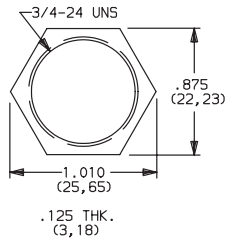

Nut part number: 175050700

**D** WITH CLIP

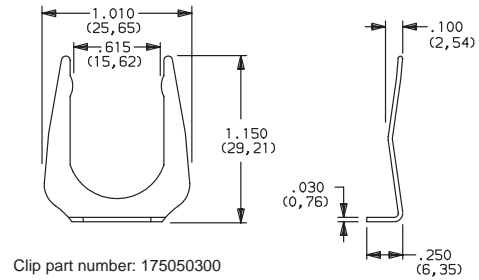

Clip part number: 175050300

**R** REMOVABLE DRESS NUT

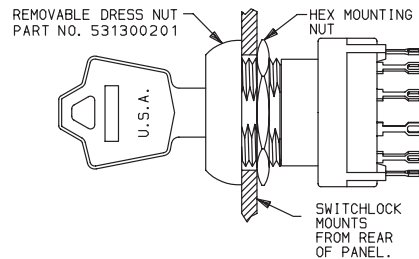
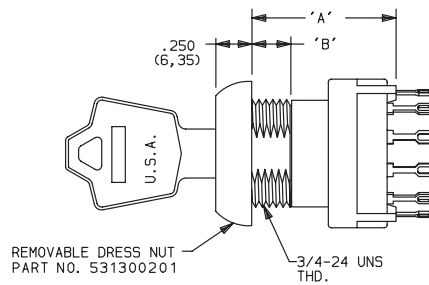
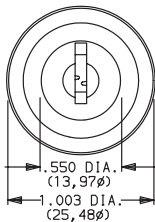

LOCK DIMENSIONS		
LOCK TYPES	DIMENSIONS	
	'A'	'B'
A	1.036 (26,31)	.270 (6,68)
B	1.133 (28,78)	.360 (9,14)

### TYPICAL INSTALLATION

Install hex nut with enough clearance to allow for dress nut and panel. Place switch through cutout in rear of panel. Install and tighten dress nut by hand, then tighten hex nut. Always tighten assembly with back of panel hex nut to avoid damaging front of panel.

### Mounting Information (All Models)

MOUNTING STYLES	PANEL THICKNESS		
	A & Y LOCK TYPES	B & G LOCK TYPES	W LOCK TYPES
D	.065 - .085 (1,65 - 2,16)		.085 - .105 (2,16 - 2,67)
N	.105 (2,67) max.	.195 (4,95) max.	.215 (5,46) max.
R	.125 (3,18) max.	.215 (5,46) max.	—

AVAILABLE OPTION COMBINATIONS										
MOUNTING STYLES	LOCK FINISHES					LOCK TYPES				
	1	2	4	8	F	G	A	W	Y	B
D		•		•	•	•		•	•	
N		•		•	•	•		•	•	
R	•		•	•			•			•

### PANEL MOUNTING

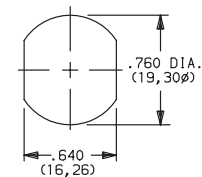

For models with 'N' or 'D' mounting styles.

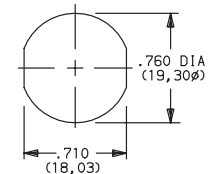

For models with 'R' mounting style.

## MOUNTING/LOCK STYLE

### Switch and Lock Assembly Instructions

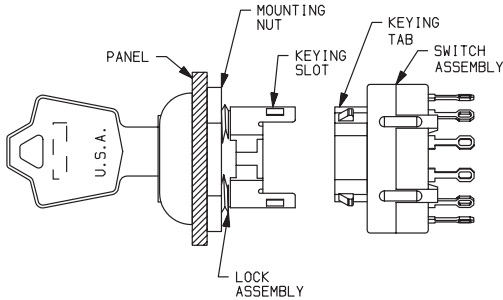

1. Place lock assembly in mounting hole on panel, secure with mounting nut.
2. Align keying tab on switch assembly with keying slot on lock assembly.
3. Snap assemblies together.
4. Switch installation is permanent. Switch cannot be removed from lock after assembly. Attempting to separate switch and lock may cause damage to switchlock.



H

Switchlock

## CONTACT MATERIAL

OPTION CODE	CONTACT AND TERMINAL MATERIAL	RATINGS	
<b>Q (STD.)</b>	SILVER <sup>2</sup>	POWER	SWITCH - 2.5 AMPS @ 125 V AC; 350 mA @ 125 V DC (UL/CSA). CARRY - 5 AMPS CONTINUOUS.
<b>B</b>	GOLD <sup>1</sup>	LOW LEVEL / DRY CIRCUIT	0.4 VA MAX. @ 20 V AC OR DC MAX.
<b>G</b>	GOLD OVER SILVER <sup>3</sup>	LOW LEVEL / DRY CIRCUIT OR POWER	0.4 VA MAX. @ 20 V AC OR DC MAX. OR SWITCH - 2.5 AMPS @ 125 V AC; 350 mA @ 125 V DC (UL/CSA). CARRY - 5 AMPS CONTINUOUS.

CONTACT MATERIAL / APPLICATION RECOMMENDATIONS — SEE CHART, PAGE L-31.

<sup>1</sup> MOVABLE CONTACT: Copper alloy, with gold plate over nickel plate.  
STATIONARY CONTACTS & TERMINALS: Brass, with gold plate over nickel plate.

<sup>2</sup> MOVABLE CONTACT: Coin silver, silver plated.  
STATIONARY CONTACTS & TERMINALS: Brass, silver plated (standard with all termination options).

<sup>3</sup> MOVABLE CONTACT: Coin silver, with gold plate over nickel plate over silver plate.  
STATIONARY CONTACTS & TERMINALS: Brass, with gold plate over nickel plate over silver plate.

All models with all options when ordered with 'G' or 'Q' contact material.

**NOTE:** 'G' contact material is equivalent to both 'B' and 'Q' contact materials.

## SEAL

**NONE** (STD.) NO SEAL

**E** EPOXY SEAL

