

GaAlAs Hermetic Infrared Emitting Diodes Types OP231, OP232, OP233

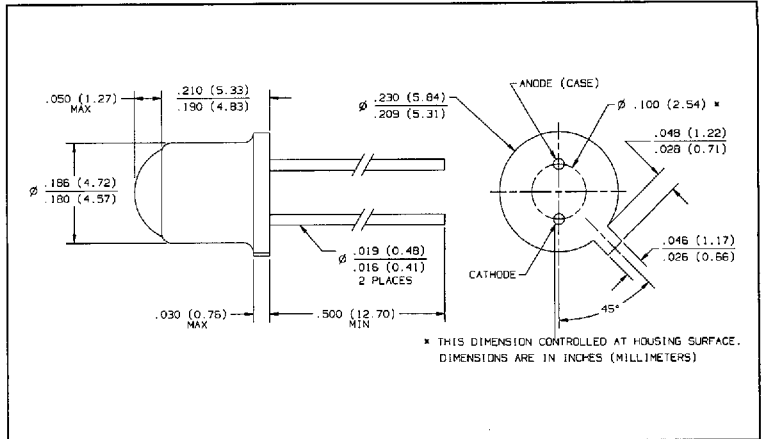
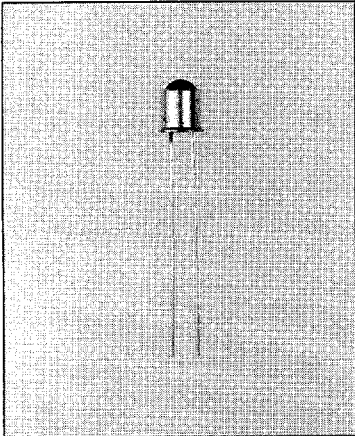

Features

- Enhanced temperature range
- TO-46 hermetically sealed package
- Mechanically and spectrally matched to OP800, OP593, and OP598 phototransistors
- Specified apertured power in ranges to satisfy most applications
- Variety of power ranges

Description

The OP231 series devices are gallium aluminum arsenide infrared emitting diodes mounted in hermetic TO-46 housings. Gallium aluminum arsenide features higher radiated output than gallium arsenide at the same forward current. The wavelength is centered at 890 nm which closely matches the spectral response of silicon phototransistors. The OP231 series is lensed to provide a narrow beam angle (18° between half power points). The narrow beam angle and the specified radiant intensity of the OP231 series allow ease of design in beam interrupt applications in conjunction with the OP800 or OP598 series photosensor.

Please refer to application bulletins 208 and 210 for additional design information and reliability (degradation) data.

Absolute Maximum Ratings ($T_A = 25^\circ\text{C}$ unless otherwise noted)

Reverse Voltage	2.0 V
Continuous Forward Current	100 mA
Peak Forward Current (2 μs pulse width, 0.1% duty cycle)	10.0 A
Storage Temperature Range	-65°C to $+150^\circ\text{C}$
Operating Temperature Range	-65°C to $+125^\circ\text{C}$
Lead Soldering Temperature [1/16 inch (1.6 mm) from case for 5 sec. with soldering iron]	$260^\circ\text{C}^{(1)}$
Power Dissipation	200 $\text{mW}^{(2)}$

Notes:

- (1) RMA flux is recommended. Duration can be extended to 10 seconds max. when flow soldering.
- (2) Derate linearly 2.0 $\text{mW}/^\circ\text{C}$ above 25°C .
- (3) $E_{e(\text{APT})}$ is a measurement of the average radiant intensity within the cone formed by the measurement surface, a radius of $1.429''$ (36.30 mm) measured from the lens side of the tab to the sensing surface and a sensing surface of $0.250''$ (6.35 mm) in diameter forming a 10° cone. $E_{e(\text{APT})}$ is not necessarily uniform within the measured area.
- (4) Measurement made with $100\mu\text{s}$ pulse measured at the trailing edge of the pulse with a duty cycle of 0.10% and an $I_F = 100\text{ mA}$.

Typical Performance Curves

Forward Voltage vs. Forward Current

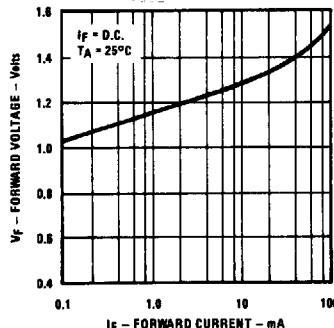

Forward Voltage and Radiant Incidence vs. Forward Current

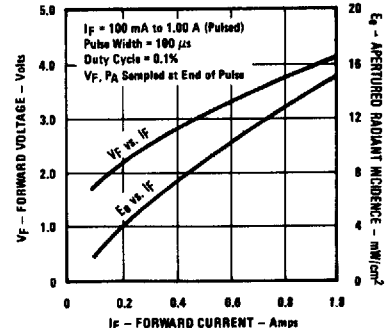

6798580 0002573 65T

Types OP231, OP232, OP233

Electrical Characteristics ($T_A = 25^\circ\text{C}$ unless otherwise noted)

SYMBOL	PARAMETER	MIN	TYP	MAX	UNITS	TEST CONDITIONS
$E_e(\text{APT})$	Apertured Radiant Incidence	OP231 OP232 OP233	1.5 2.0 3.0		mW/cm^2 mW/cm^2 mW/cm^2	$I_F = 100\text{ mA}^{(3)(4)}$ $I_F = 100\text{ mA}^{(3)(4)}$ $I_F = 100\text{ mA}^{(3)(4)}$
P_o	Radiant Power Output	OP231 OP232 OP233	6.0 8.0 10.0		mW mW mW	$I_F = 100\text{ mA}^{(3)(4)}$ $I_F = 100\text{ mA}^{(3)(4)}$ $I_F = 100\text{ mA}^{(3)(4)}$
V_F	Forward Voltage			2.0	V	$I_F = 100\text{ mA}^{(4)}$
I_R	Reverse Current			100	μA	$V_R = 2\text{ V}$
λ_p	Wavelength at Peak Emission		890		nm	$I_F = 10\text{ mA}$
B	Spectral Bandwidth Between Half Power Points		80		nm	$I_F = 10\text{ mA}$
$\Delta\lambda_p/\Delta T$	Spectral Shift with Temperature		+0.30		$\text{nm}/^\circ\text{C}$	$I_F = \text{Constant}$
θ_{HP}	Emission Angle at Half Power Points		18		Deg.	$I_F = 100\text{ mA}$
t_r	Output Rise Time		500		ns	$I_{F(\text{PK})} = 100\text{ mA}$, $\text{PW} = 10\ \mu\text{s}$, D.C. = 10%
t_f	Output Fall Time		250		ns	$I_{F(\text{PK})} = 100\text{ mA}$, $\text{PW} = 10\ \mu\text{s}$, D.C. = 10%

INFRARED
EMITTING
DIODES

Typical Performance Curves

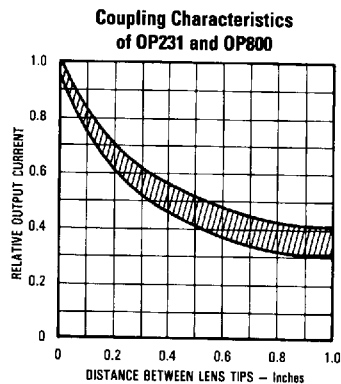
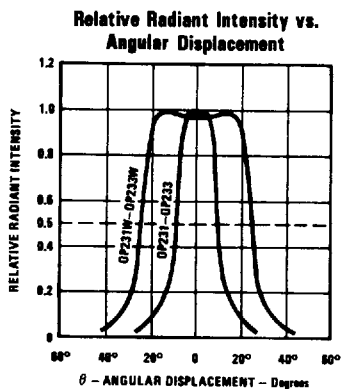
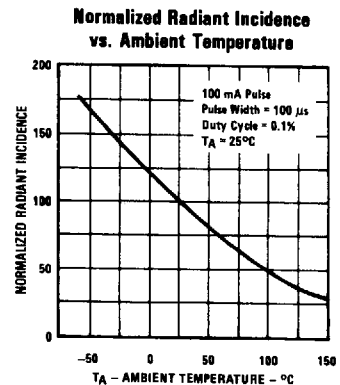
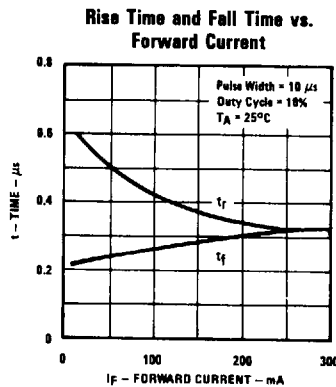
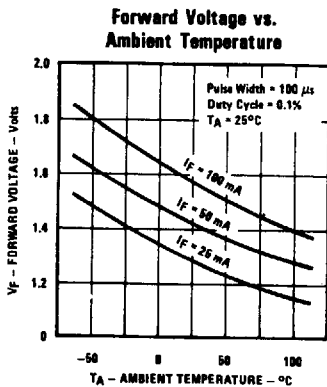

6798580 0002574 596

Optek reserves the right to make changes at any time in order to improve design and to supply the best product possible.

Optek Technology, Inc.

1215 W. Crosby Road

Carrollton, Texas 75006

(972)323-2200

Fax (972)323-2396