

## LOW VOLTAGE AUDIO POWER AMPLIFIER

### ■ GENERAL DESCRIPTION

The NJM2113 is a audio power amplifier designed for telephone applications, such as in speakerphones.

Coupling capacitors to the speaker are not required, as it has differential speaker outputs. The closed loop gain is set with two external resistors. A CD pin permit powering down with muting the input signal.

### ■ FEATURES

- Wide Operating Voltage (2~16V)
- Low Operating Current (2.7mA Typ.)
- CD Input to Power Down the IC with Mute
- Low Power-Down Operating Current (72μA Typ.)
- Output Power Exceeds 250mW ( $V^+=6V, R_L=32\Omega$ )
- Gain Adjustable ( $G_{VD}=0\sim 43\text{dB}$ , Voice Band)
- Package Outline DMP8, DIP8, SIP8, SSOP8, VSP8, EMP8
- Bipolar Technology

### ■ PACKAGE OUTLINE

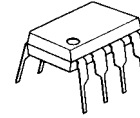

NJM2113D



NJM2113M

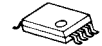

NJM2113V

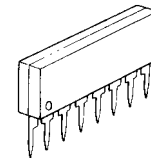

NJM2113L



NJM2113R

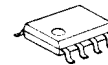

NJM2113E

### ■ RECOMMENDED OPERATING CONDITIONS

- Load Impedance  $R_L$  8~200Ω
- Differential Gain  $G_{VD}$  0~43dB (5kHz bandwidth)
- Input Voltage at CD  $V_{CD}$  0~ $V^+V_{dc}$

### ■ PIN CONFIGURATION

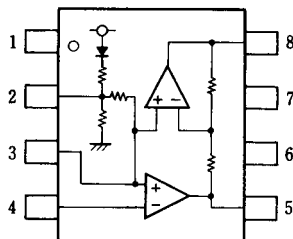

NJM2113D  
NJM2113M  
NJM2113V  
NJM2113R

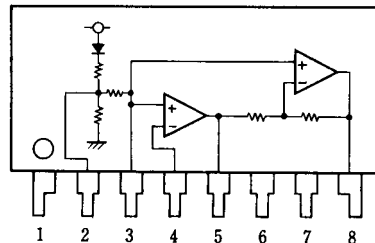

NJM2113L

### PIN FUNCTION

1. CD
2.  $V_{REF}$
3.  $+V_{IN}$
4.  $-V_{IN}$
5.  $V_{OUT1}$
6.  $V^+$
7. GND
8.  $V_{OUT2}$

### ■ BLOCK DIAGRAM

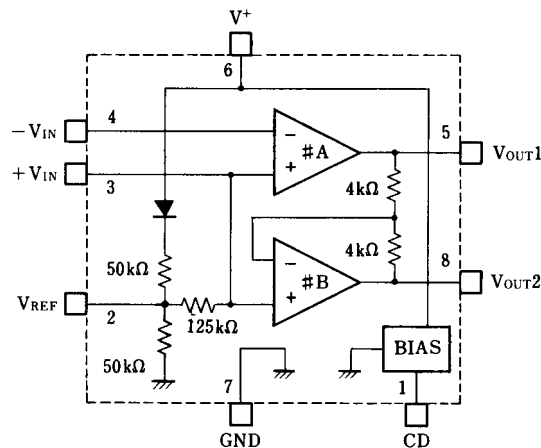

# NJM2113

## ■ ABSOLUTE MAXIMUM RATINGS

( Ta=25°C )

PARAMETER	SYMBOL	RATINGS	UNIT
Supply Voltage	V <sup>+</sup>	+18	V
Output Peak Current	I <sub>OP</sub>	± 250	mA
Input Voltage Range	V <sub>IN</sub>	( 1~4pin )-0.3 to V <sup>+</sup> +0.3 ( 5,8pin )-0.3 to V <sup>+</sup> +0.3 ( when Power-Down )	V
Power Dissipation	P <sub>D</sub>	( DIP8 ) 500 ( SIP8 ) 800 ( DMP8 ) 500 ( note1 ) ( SSOP8 ) 360 ( note1 ) ( VSP8 ) 320 ( EMP8 ) 300	mW
Operating Temperature Range	T <sub>opr</sub>	-20~+75	°C
Storage Temperature Range	T <sub>stg</sub>	-40~+125	°C

( note1 ) Mounted on PC Board

## ■ ELECTRICAL CHARACTERISTICS

( V<sup>+</sup>=6V, Ta=25°C, unless otherwise specified )

PARAMETER	SYMBOL	TEST CONDITION	MIN.	TYP.	MAX.	UNIT
Operating Current ( no signal )	I <sub>CC1</sub>	V <sup>+</sup> =3.0V, R <sub>L</sub> =∞, 1pin=0.8V	-	2.7	4.0	mA
	I <sub>CC2</sub>	V <sup>+</sup> =16.0V, R <sub>L</sub> =∞, 1pin=0.8V	-	3.4	5.0	mA
	I <sub>CCD</sub>	V <sup>+</sup> =3.0V, R <sub>L</sub> =∞, 1pin=2.0V	-	72	100	μA
Open Loop Gain	A <sub>V1</sub>	Amplifier#A, f<100Hz	77	83	-	dB
Closed Loop Gain	A <sub>V2</sub>	Amplifier#B, f=1kHz, R <sub>L</sub> =32Ω	-0.35	0	+0.35	dB
Output Power ( note2 )	P <sub>O1</sub>	V <sup>+</sup> =3.0V, R <sub>L</sub> =16Ω, THD≤10%	55	-	-	mW
	P <sub>O2</sub>	V <sup>+</sup> =6.0V, R <sub>L</sub> =32Ω, THD≤10%	250	-	-	mW
	P <sub>O3</sub>	V <sup>+</sup> =12.0V, R <sub>L</sub> =100Ω, THD≤10% ( note3 )	400	-	-	mW
Total Harmonic Distortion ( f=1kHz )	THD1	V <sup>+</sup> =6V, R <sub>L</sub> =32Ω, P <sub>O</sub> =125mW, G <sub>VD</sub> =34dB	-	0.5	1.0	%
	THD2	V <sup>+</sup> ≥3V, R <sub>L</sub> =8Ω, P <sub>O</sub> =20mW, G <sub>VD</sub> =12dB	-	0.5	-	%
	THD3	V <sup>+</sup> ≥12V, R <sub>L</sub> =32Ω, P <sub>O</sub> =200mW, G <sub>VD</sub> =34dB	-	0.6	-	%
Power Supply Rejection Ratio ( V <sup>+</sup> =6.0V, ΔV <sup>+</sup> =3.0V )	PSRR1	C1=∞, C2=0.01μF, DC	50	-	-	dB
	PSRR2	C1=0.1μF, C2=0, f=1kHz	-	12	-	dB
	PSRR3	C1=1.0μF, C2=5.0μF, f=1kHz	-	52	-	dB
Mute Attenuation	MAT	f=1kHz~20kHz, 1pin=2.0V	-	70	-	dB
Output Voltage ( R <sub>f</sub> =75kΩ, DC )	V <sub>O1</sub>	V <sup>+</sup> =3.0V, R <sub>L</sub> =16Ω	1.00	1.18	1.25	V
	V <sub>O2</sub>	V <sup>+</sup> =6.0V	-	2.68	-	V
	V <sub>O3</sub>	V <sup>+</sup> =12.0V	-	5.71	-	V
Output High Level	V <sub>OH</sub>	I <sub>OUT</sub> =-75mA, V <sup>+</sup> =2.0~16.0V	-	V <sup>+</sup> -1.1	-	V
Output Low Level	V <sub>OL</sub>	I <sub>OUT</sub> =75mA, V <sup>+</sup> =2.0~16.0V	-	0.21	-	V
Output DC Offset	ΔV <sub>O</sub>	R <sub>f</sub> =75kΩ, R <sub>L</sub> =32Ω, 5pin~8pin	-30	0	+30	mV
Input Bias Current Equivalent Resistance	I <sub>B</sub>	4pin	-	-30	-200	nA
	R <sub>HIN</sub>	3pin	100	150	220	kΩ
	R <sub>REF</sub>	2pin	18	25	40	kΩ
CD Input Voltage H	V <sub>CDH</sub>	1pin	2.0	-	V <sup>+</sup>	V
CD Input Voltage L	V <sub>CDL</sub>	1pin	0.0	-	0.8	V
CD Input Resistance	R <sub>CD</sub>	V <sub>CD</sub> =16.0V, 1pin	50	75	175	kΩ

( note2 ) NJM2113M, NJM2113V : At on PC Board

( note3 ) Not specified for NJM2113V, NJM2113R

## ■ APPLICATION CIRCUIT

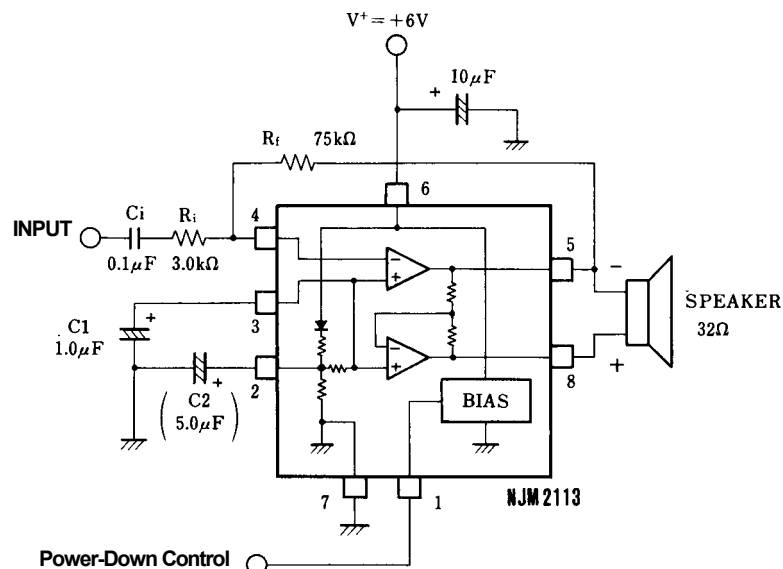

( note )

1. The NJM2113 is active mode during the CD terminal is Low level ( $<0.8V$ ) and it is stand-by mode during the CD terminal is High level ( $>2.0V$ )
2. C1 and C2 improve power supply rejection ratio.  
In case of C1 is enough large, C2 is unnecessary.
3. Please note that the C1 and C2 make slow power rise up to the NJM2113 regardless the external power supply condition.
4. Input current flow on the internal resistor shown in the equivalent circuit of CD terminal.
5. No snubber resistor and capacitor are required normally.  
But the snubber resistor and capacitor are required if the NJM2113 oscillates by Condition of PCB layout, stray capacitor and speaker wire length.

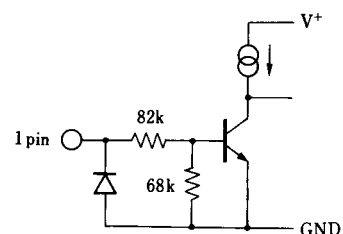

## ■ TYPICAL CHARACTERISTICS

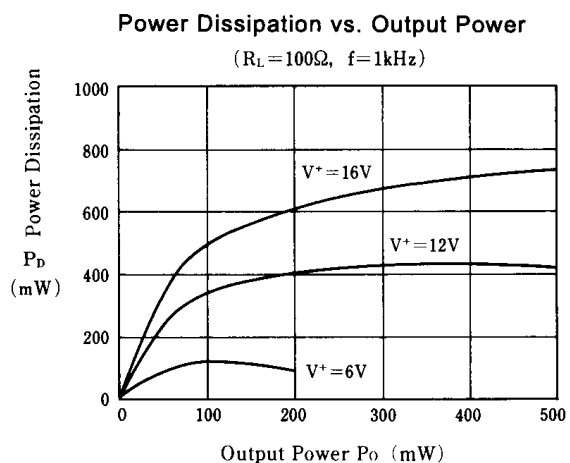
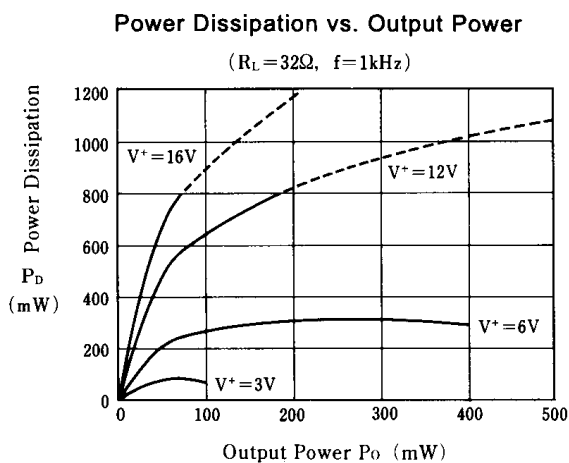
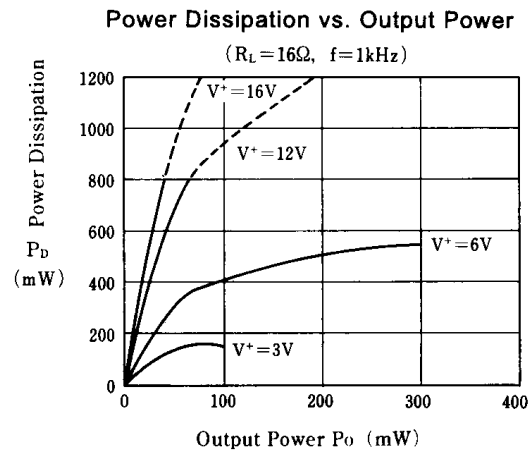
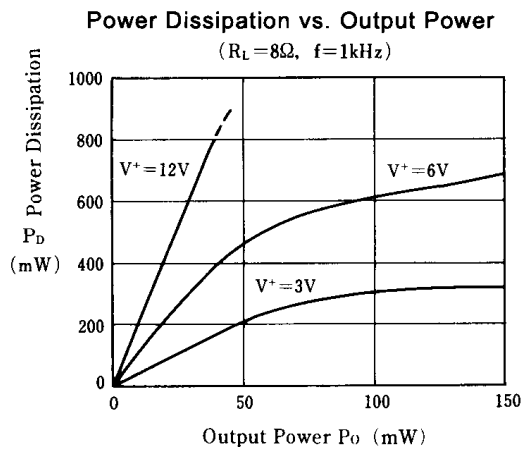
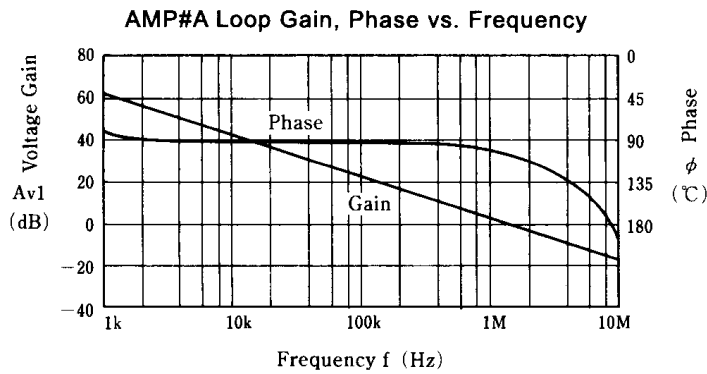

## ■ TYPICAL CHARACTERISTICS

### Operating Current vs. Supply Voltage

( $T_a=25^\circ\text{C}$ )

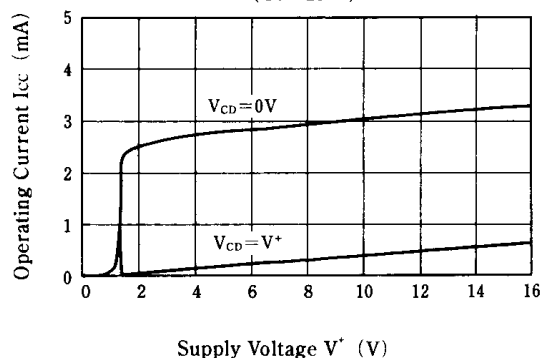

### CD Terminal Sink Current vs. Apply Voltage

$V^+=16\text{V}$



### Power Supply Rejection Ratio vs. Frequency

( $C_2=0\mu\text{F}$ )

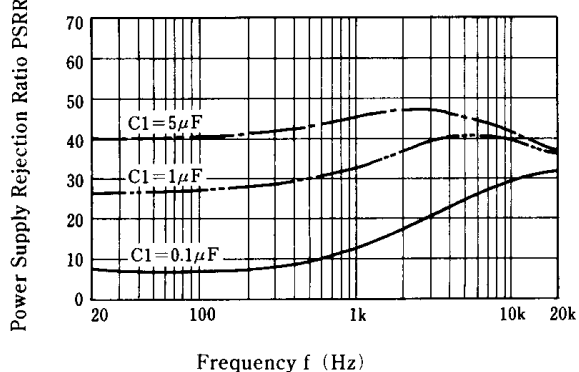

### Power Supply Rejection Ratio vs. Frequency

( $C_2=1\mu\text{F}$ )

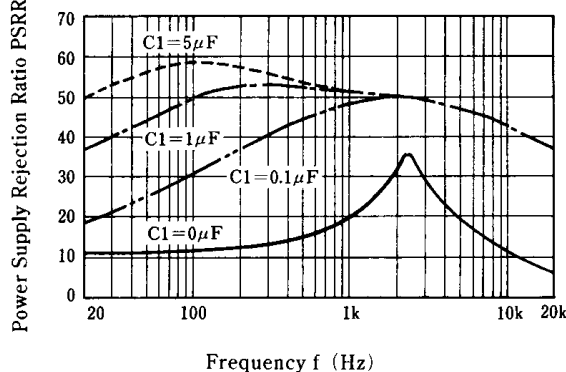

### Power Supply Rejection Ratio vs. Frequency

( $C_2=5\mu\text{F}$ )

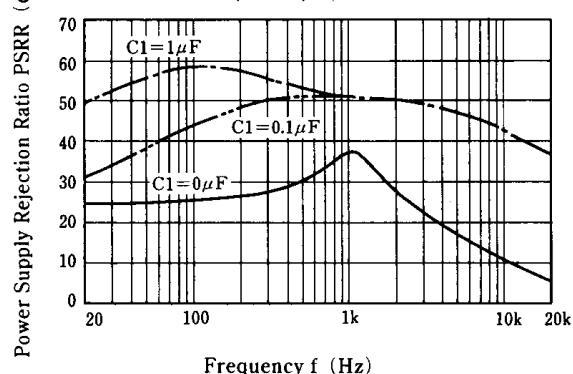

### Power Supply Rejection Ratio vs. Frequency

( $C_2=10\mu\text{F}$ )



## ■ TYPICAL CHARACTERISTICS

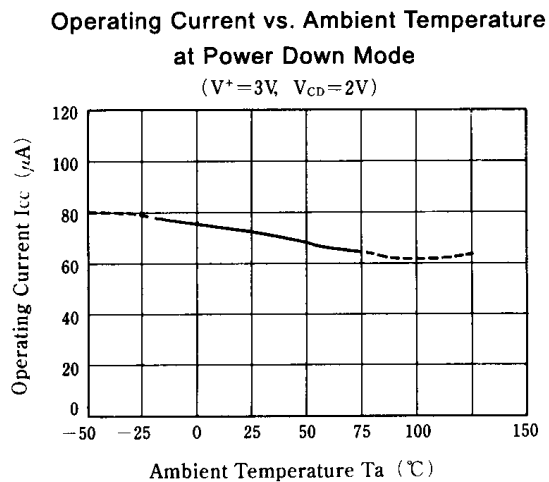
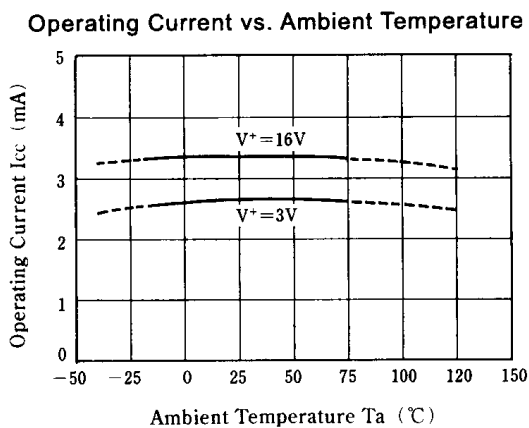
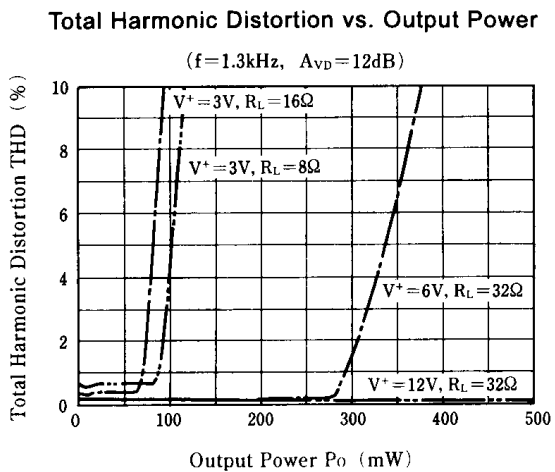
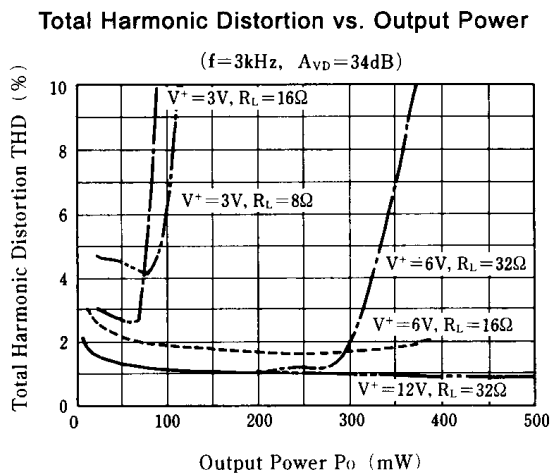
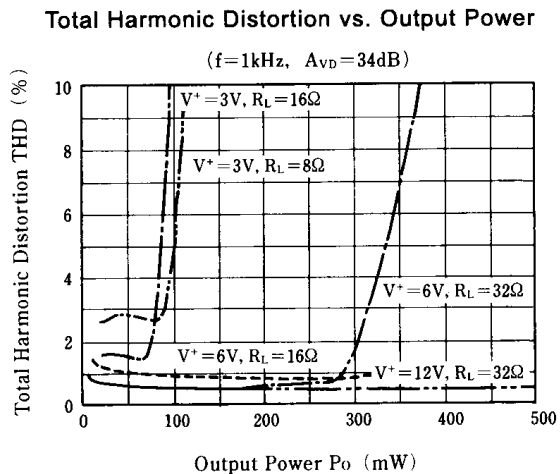

**[CAUTION]**

The specifications on this databook are only given for information, without any guarantee as regards either mistakes or omissions. The application circuits in this databook are described only to show representative usages of the product and not intended for the guarantee or permission of any right including the industrial rights.