

## FPNH10

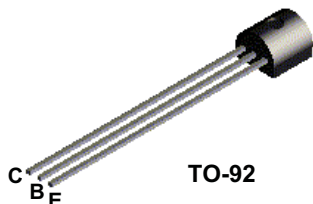

### NPN RF Transistor

This device is designed for use in low noise UHF/VHF amplifiers, with collector currents in the 100  $\mu$ A to 20 mA range in common emitter or common base mode of operations, and in low frequency drift, high output UHF oscillators. Sourced from Process 42.

#### Absolute Maximum Ratings\*

TA = 25°C unless otherwise noted

Symbol	Parameter	Value	Units
V <sub>CEO</sub>	Collector-Emitter Voltage	25	V
V <sub>CBO</sub>	Collector-Base Voltage	30	V
V <sub>EBO</sub>	Emitter-Base Voltage	3.0	V
I <sub>C</sub>	Collector Current - Continuous	50	mA
T <sub>J</sub> , T <sub>stg</sub>	Operating and Storage Junction Temperature Range	-55 to +150	°C

\*These ratings are limiting values above which the serviceability of any semiconductor device may be impaired.

#### NOTES:

- 1) These ratings are based on a maximum junction temperature of 150 degrees C.
- 2) These are steady state limits. The factory should be consulted on applications involving pulsed or low duty cycle operations.

#### Thermal Characteristics

TA = 25°C unless otherwise noted

Symbol	Characteristic	Max	Units
		FPNH10	
P <sub>D</sub>	Total Device Dissipation Derate above 25°C	350	mW
		2.8	mW/°C
R <sub>θJC</sub>	Thermal Resistance, Junction to Case	125	°C/W
R <sub>θJA</sub>	Thermal Resistance, Junction to Ambient	357	°C/W

\*Device mounted on FR-4 PCB 1.6" X 1.6" X 0.06."

**NPN RF Transistor**  
(continued)

**FPNH10**

**Electrical Characteristics**

TA = 25°C unless otherwise noted

Symbol	Parameter	Test Conditions	Min	Max	Units
--------	-----------	-----------------	-----	-----	-------

**OFF CHARACTERISTICS**

$V_{(BR)CEO}$	Collector-Emitter Sustaining Voltage*	$I_C = 1.0 \text{ mA}, I_B = 0$	25		V
$V_{(BR)CBO}$	Collector-Base Breakdown Voltage	$I_C = 100 \text{ } \mu\text{A}, I_E = 0$	30		V
$V_{(BR)EBO}$	Emitter-Base Breakdown Voltage	$I_E = 10 \text{ } \mu\text{A}, I_C = 0$	3.0		V
$I_{CBO}$	Collector Cutoff Current	$V_{CB} = 25 \text{ V}, I_E = 0$		100	nA
$I_{EBO}$	Emitter Cutoff Current	$V_{EB} = 2.0 \text{ V}, I_C = 0$		100	nA

**ON CHARACTERISTICS**

$h_{FE}$	DC Current Gain	$I_C = 4.0 \text{ mA}, V_{CE} = 10 \text{ V}$	60		
$V_{CE(sat)}$	Collector-Emitter Saturation Voltage	$I_C = 4.0 \text{ mA}, I_B = 0.4 \text{ mA}$		0.5	V
$V_{BE(on)}$	Base-Emitter On Voltage	$I_C = 4.0 \text{ mA}, V_{CE} = 10 \text{ V}$		0.95	V

**SMALL SIGNAL CHARACTERISTICS**

$f_T$	Current Gain - Bandwidth Product	$I_C = 4.0 \text{ mA}, V_{CE} = 10 \text{ V}, f = 100 \text{ MHz}$	650		MHz
$C_{cb}$	Collector-Base Capacitance	$V_{CB} = 10 \text{ V}, I_E = 0, f = 1.0 \text{ MHz}$		0.720	pF
$C_{rb}$	Common-Base Feedback Capacitance	$V_{CB} = 10 \text{ V}, I_E = 0, f = 1.0 \text{ MHz}$	0.34	0.65	pF
$rb'C_c$	Collector Base Time Constant	$I_C = 4.0 \text{ mA}, V_{CB} = 10 \text{ V}, f = 31.8 \text{ MHz}$		9.0	ps

\*Pulse Test: Pulse Width  $\leq 300 \text{ } \mu\text{s}$ , Duty Cycle  $\leq 2.0\%$

**Spice Model**

NPN (Is=69.28E-18 Xti=3 Eg=1.11 Vaf=100 Bf=308.6 Ne=1.197 Ise=69.28E-18 Ikf=22.83m Xtb=1.5 Br=1.11 Nc=2 Isc=0 Ikr=0 Rc=4 Cjc=1.042p Mjc=.2468 Vjc=.75 Fc=.5 Cje=1.52p Mje=.3223 Vje=.75 Tr=1.558n Tf=135.8p Itf=.27 Vtf=10 Xtf=30 Rb=10)

Typical Characteristics

Typical Pulsed Current Gain vs Collector Current

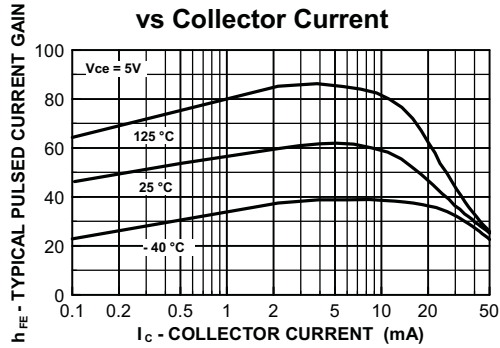

Collector-Emitter Saturation Voltage vs Collector Current

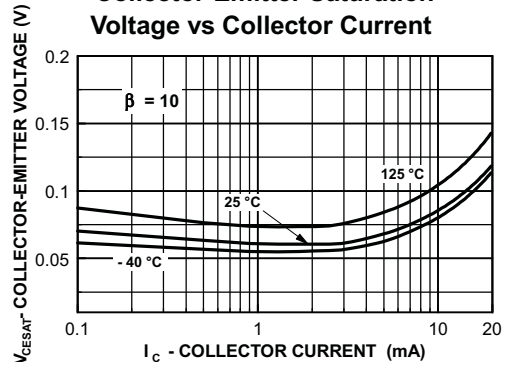

Base-Emitter Saturation Voltage vs Collector Current

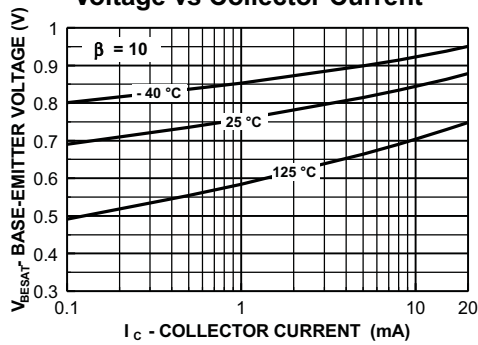

Base-Emitter ON Voltage vs Collector Current

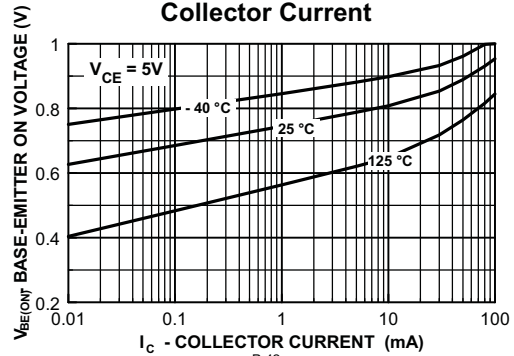

Collector-Cutoff Current vs Ambient Temperature

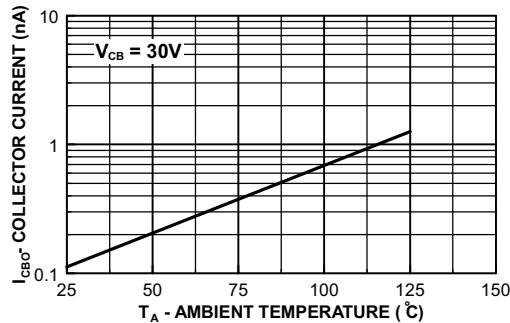

Power Dissipation vs. Ambient Temperature

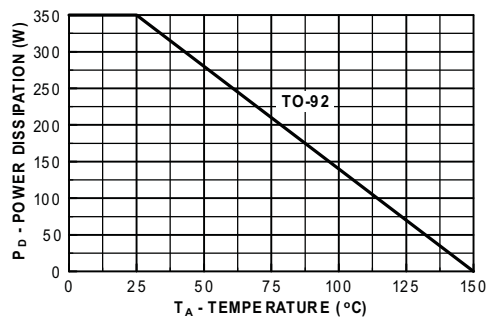

Common Base Y Parameters vs. Frequency

Input Admittance

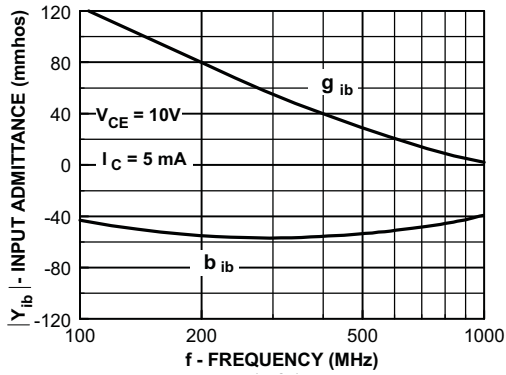

Output Admittance

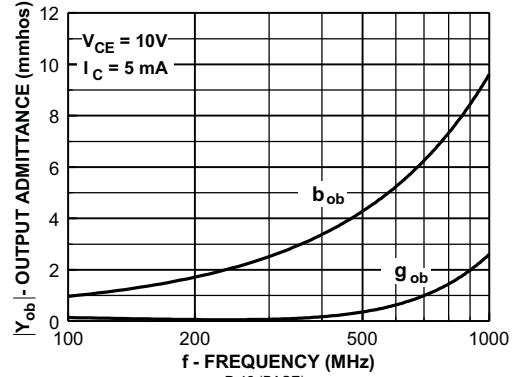

Forward Transfer Admittance

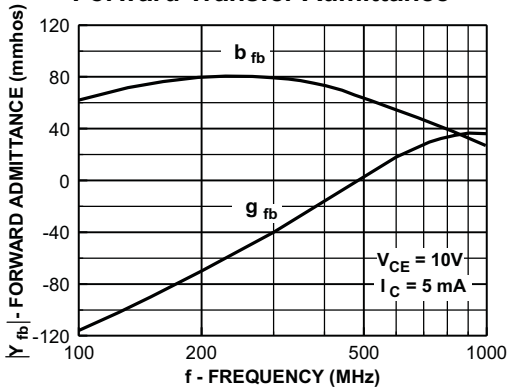

Reverse Transfer Admittance

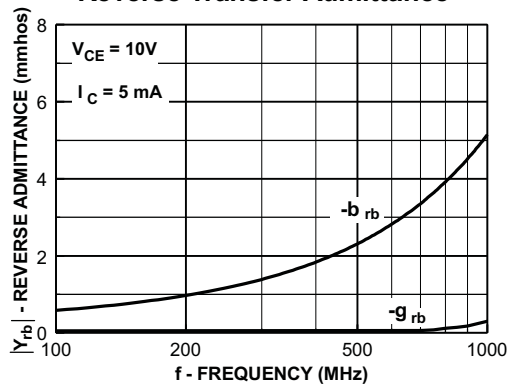

Common Emitter Y Parameters vs. Frequency

Input Admittance

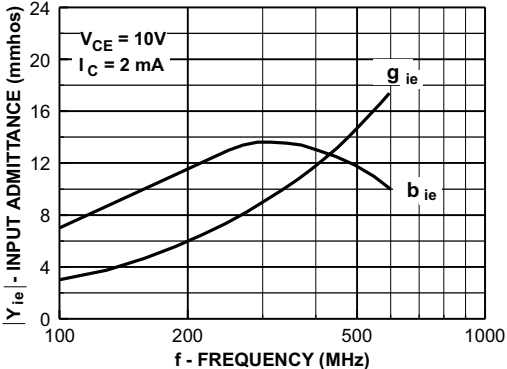

Output Admittance

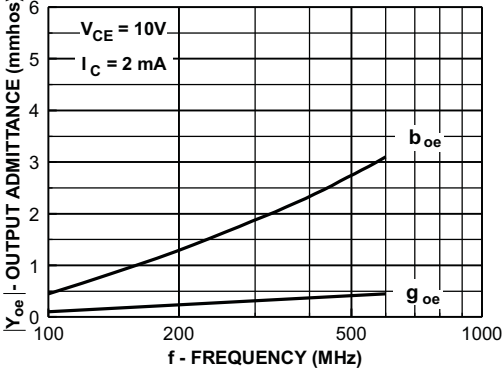

Forward Transfer Admittance

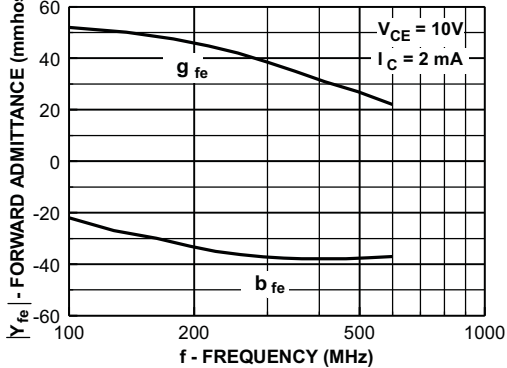

Reverse Transfer Admittance

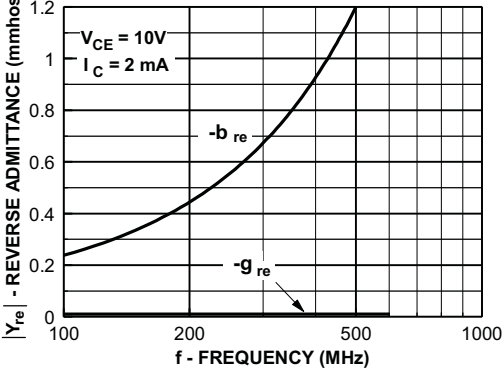

Test Circuits

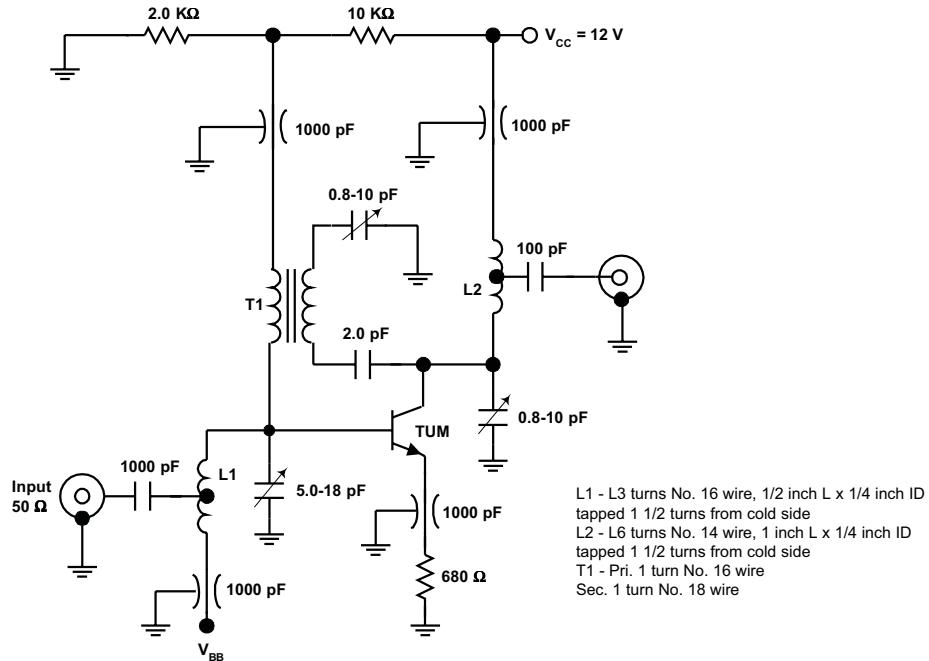

FIGURE 1: Neutralized 200 MHz pF and NF Circuit

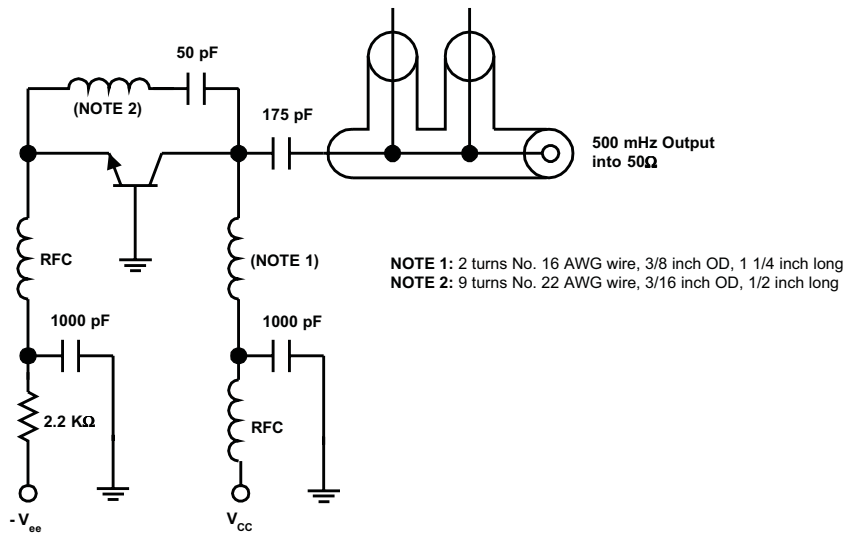

FIGURE 2: 500 MHz Oscillator Circuit

## TRADEMARKS

The following are registered and unregistered trademarks Fairchild Semiconductor owns or is authorized to use and is not intended to be an exhaustive list of all such trademarks.

ACE <sup>x</sup> ™	FAST <sup>r</sup> ™	PowerTrench®	SyncFET™
Bottomless™	GlobalOptoisolator™	QFET™	TinyLogic™
CoolFET™	GTO™	QS™	UHC™
CROSSVOLT™	HiSeC™	QT Optoelectronics™	VCX™
DOME™	ISOPLANAR™	Quiet Series™	
E <sup>2</sup> CMOS™	MICROWIRE™	SILENT SWITCHER®	
EnSigna™	OPTOLOGIC™	SMART START™	
FACT™	OPTOPLANAR™	SuperSOT™-3	
FACT Quiet Series™	PACMAN™	SuperSOT™-6	
FAST®	POP™	SuperSOT™-8	

## DISCLAIMER

FAIRCHILD SEMICONDUCTOR RESERVES THE RIGHT TO MAKE CHANGES WITHOUT FURTHER NOTICE TO ANY PRODUCTS HEREIN TO IMPROVE RELIABILITY, FUNCTION OR DESIGN. FAIRCHILD DOES NOT ASSUME ANY LIABILITY ARISING OUT OF THE APPLICATION OR USE OF ANY PRODUCT OR CIRCUIT DESCRIBED HEREIN; NEITHER DOES IT CONVEY ANY LICENSE UNDER ITS PATENT RIGHTS, NOR THE RIGHTS OF OTHERS.

## LIFE SUPPORT POLICY

FAIRCHILD'S PRODUCTS ARE NOT AUTHORIZED FOR USE AS CRITICAL COMPONENTS IN LIFE SUPPORT DEVICES OR SYSTEMS WITHOUT THE EXPRESS WRITTEN APPROVAL OF FAIRCHILD SEMICONDUCTOR CORPORATION. As used herein:

1. Life support devices or systems are devices or systems which, (a) are intended for surgical implant into the body, or (b) support or sustain life, or (c) whose failure to perform when properly used in accordance with instructions for use provided in the labeling, can be reasonably expected to result in significant injury to the user.
2. A critical component is any component of a life support device or system whose failure to perform can be reasonably expected to cause the failure of the life support device or system, or to affect its safety or effectiveness.

## PRODUCT STATUS DEFINITIONS

### Definition of Terms

Datasheet Identification	Product Status	Definition
Advance Information	Formative or In Design	This datasheet contains the design specifications for product development. Specifications may change in any manner without notice.
Preliminary	First Production	This datasheet contains preliminary data, and supplementary data will be published at a later date. Fairchild Semiconductor reserves the right to make changes at any time without notice in order to improve design.
No Identification Needed	Full Production	This datasheet contains final specifications. Fairchild Semiconductor reserves the right to make changes at any time without notice in order to improve design.
Obsolete	Not In Production	This datasheet contains specifications on a product that has been discontinued by Fairchild semiconductor. The datasheet is printed for reference information only.