

## Photo Modules for PCM Remote Control Systems

### Available types for different carrier frequencies

Type	fo	Type	fo
TFMM 5300	30 kHz	TFMM 5330	33 kHz
TFMM 5360	36 kHz	TFMM 5370	36.7 kHz
TFMM 5380	38 kHz	TFMM 5400	40 kHz
TFMM 5560	56 kHz		

### Description

The TFMM5..0 – series are miniaturized receivers for infrared remote control systems. PIN diode and pre-amplifier are assembled on PC board, the epoxy package is designed as IR filter.

The demodulated output signal can directly be decoded by a microprocessor. The main benefit is the reliable function even in disturbed ambient and the protection against uncontrolled output pulses.

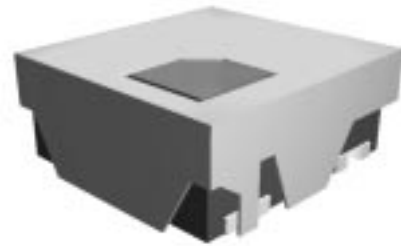

95 10266

### Features

- Photo detector and preamplifier in one package
- Output active low
- Internal filter for PCM frequency
- High immunity against ambient light
- High shielding against electric field disturbance
- 5 Volt supply voltage, low power consumption
- TTL and CMOS compatibility
- Continuous transmission possible ( $t_{pi}/T \leq 0.4$ )
- SMD

### Block Diagram

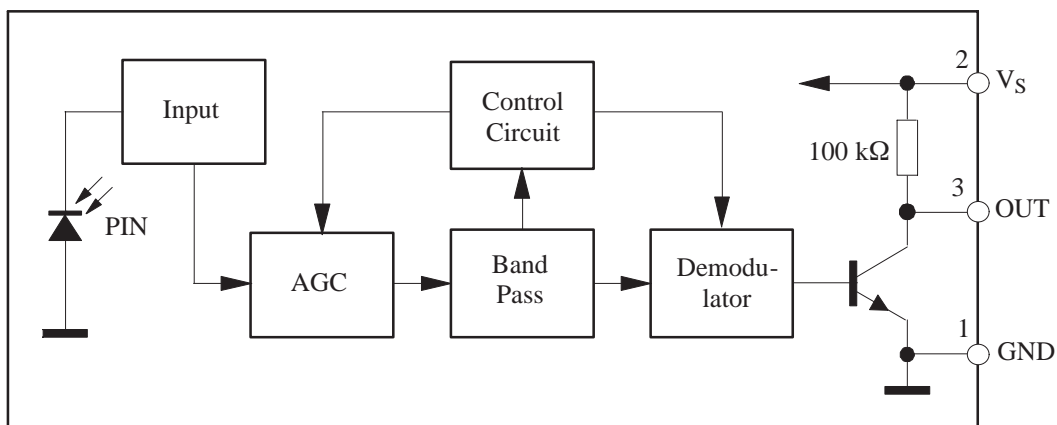

94 8136

### Absolute Maximum Ratings

$T_{amb} = 25^{\circ}\text{C}$

Parameter	Test Conditions	Symbol	Value	Unit
Supply Voltage	(Pin 2)	$V_S$	-0.3...6.0	V
Supply Current	(Pin 2)	$I_S$	5	mA
Output Voltage	(Pin 3)	$V_O$	-0.3...6.0	V
Output Current	(Pin 3)	$I_O$	5	mA
Junction Temperature		$T_j$	100	$^{\circ}\text{C}$
Storage Temperature Range		$T_{stg}$	-40...+85	$^{\circ}\text{C}$
Operating Temperature Range		$T_{amb}$	-25...+85	$^{\circ}\text{C}$
Power Consumption	( $T_{amb} \leq 85^{\circ}\text{C}$ )	$P_{tot}$	50	mW
Soldering Temperature	$t \leq 10\text{ s}$ , 1 mm from case	$T_{sd}$	230	$^{\circ}\text{C}$

### Basic Characteristics

$T_{amb} = 25^{\circ}\text{C}$

Parameter	Test Conditions	Symbol	Min	Typ	Max	Unit
Supply Current (Pin 2)	$V_S = 5\text{ V}$ , $E_v = 0$	$I_{SD}$	0.4	0.5	0.8	mA
	$V_S = 5\text{ V}$ , $E_v = 40\text{ klx}$ , sunlight	$I_{SH}$		1.0		mA
Transmission Distance	$E_v = 0$ , test signal see fig.7, IR diode TSIP5201, $I_F = 1.5\text{ A}$	$d$		35		m
Output Voltage Low (Pin 3)	$I_{OSL} = 0.5\text{ mA}$ , $E_e = 0.7\text{ mW/m}^2$ , $f = f_o$ , $t_p/T = 0.4$	$V_{OSL}$			250	mV
Irradiance (30 – 40 kHz)	Pulse width tolerance: $t_{po} = t_{pi} \pm 160\text{ }\mu\text{s}$ , test signal (see fig.7)	$E_{e\ min}$		0.6		$\text{mW/m}^2$
Irradiance (56 kHz)		$E_{e\ min}$		0.8		$\text{mW/m}^2$
Irradiance		$E_{e\ max}$	20			$\text{W/m}^2$
Directivity	Angle of half transmission distance	$\phi_{1/2}$		$\pm 40$		deg

### Application Circuit

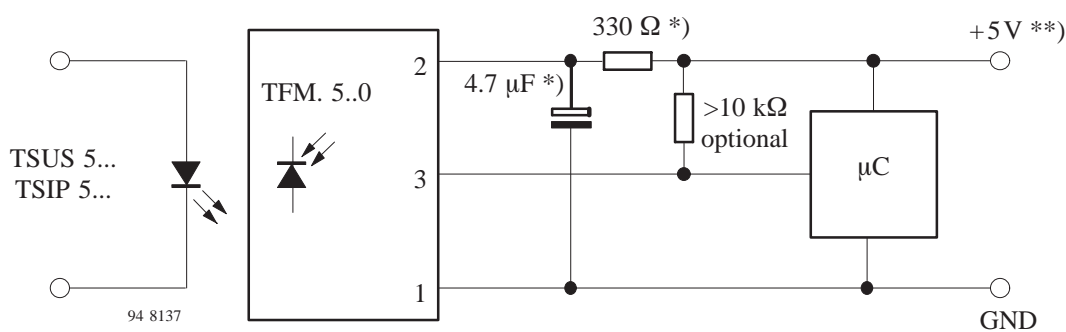

\*) only necessary to suppress power supply disturbances

\*\*\*) tolerated supply voltage range :  $4.5\text{ V} < V_S < 5.5\text{ V}$

**Typical Characteristics** ( $T_{amb} = 25^{\circ}\text{C}$  unless otherwise specified)

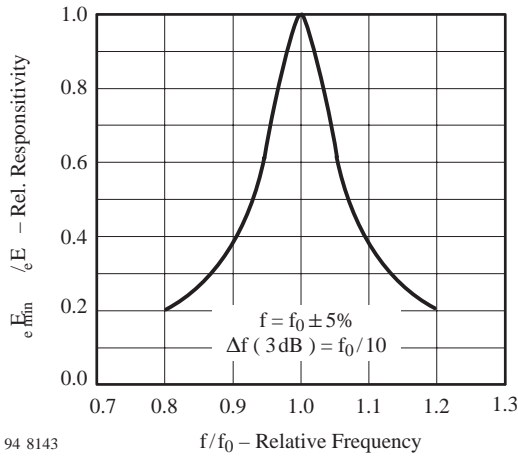

Figure 1. Frequency Dependence of Responsivity

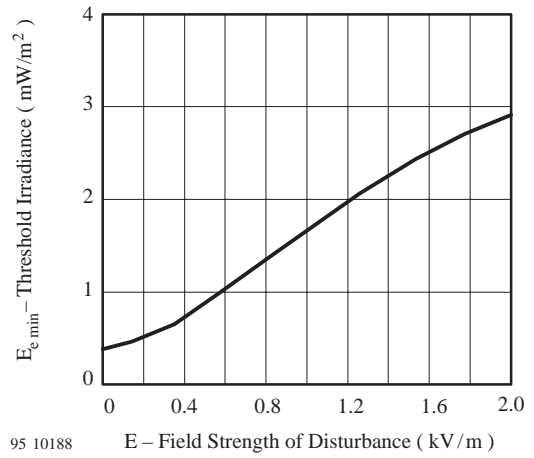

Figure 4. Sensitivity vs. Electric Field Disturbances

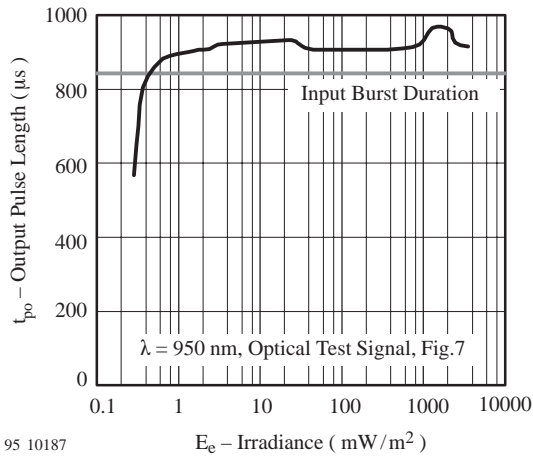

Figure 2. Sensitivity in Dark Ambient

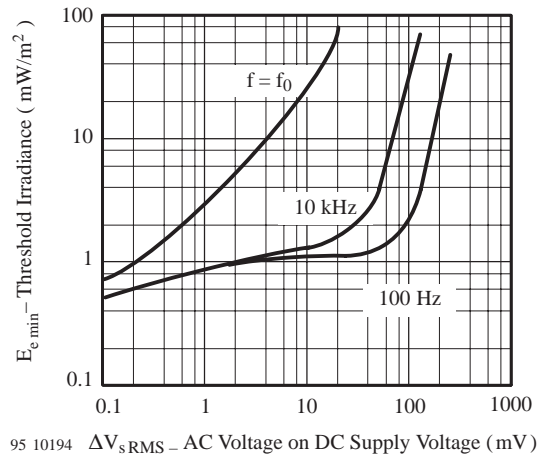

Figure 5. Sensitivity vs. Supply Voltage Disturbances

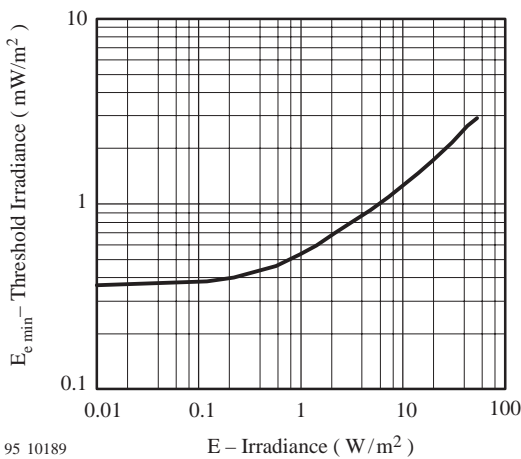

Figure 3. Sensitivity in Bright Ambient

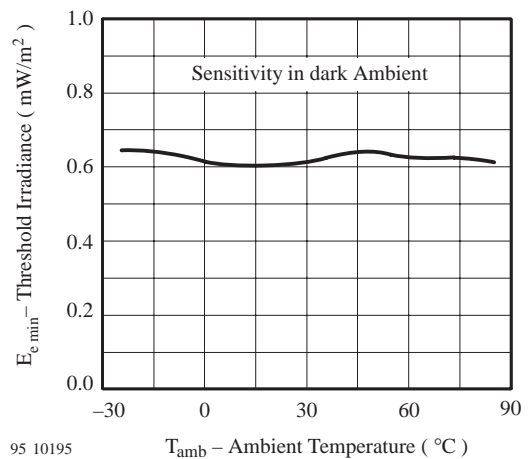

Figure 6. Sensitivity vs. Ambient Temperature

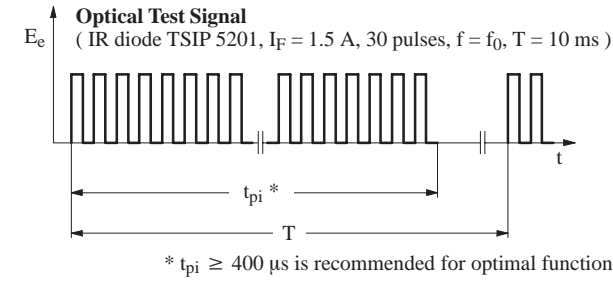

Figure 7. Output Function

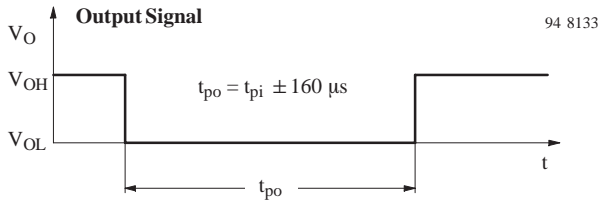

Figure 8. Output Function

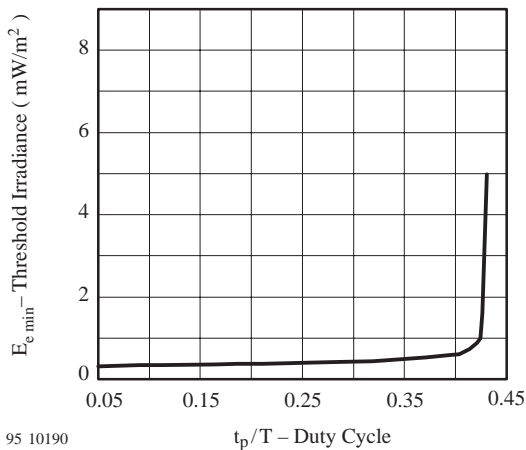

Figure 9. Sensitivity vs. Duty Cycle

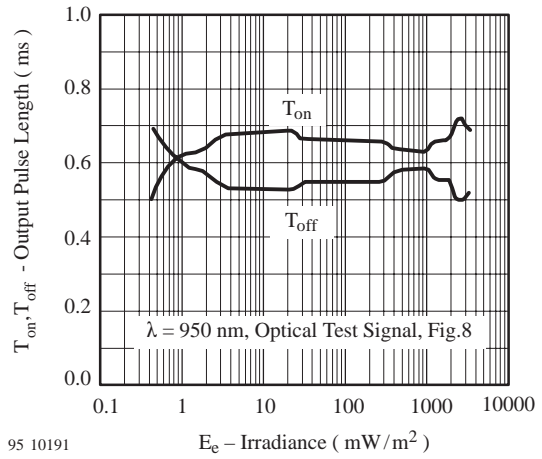

Figure 10. Output Pulse Diagram

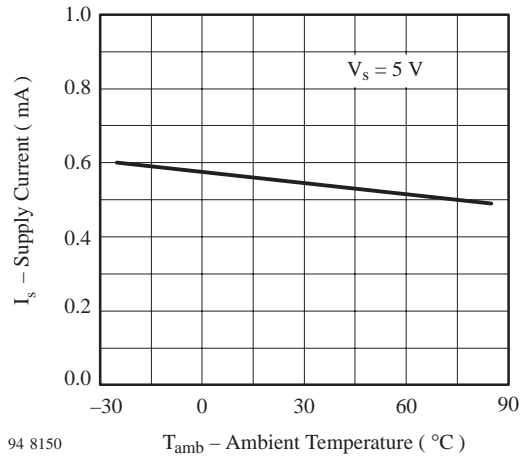

Figure 11. Supply Current vs. Ambient Temperature

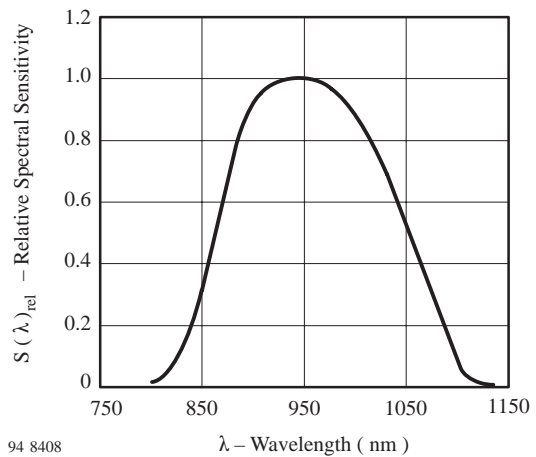

Figure 12. Relative Spectral Sensitivity vs. Wavelength

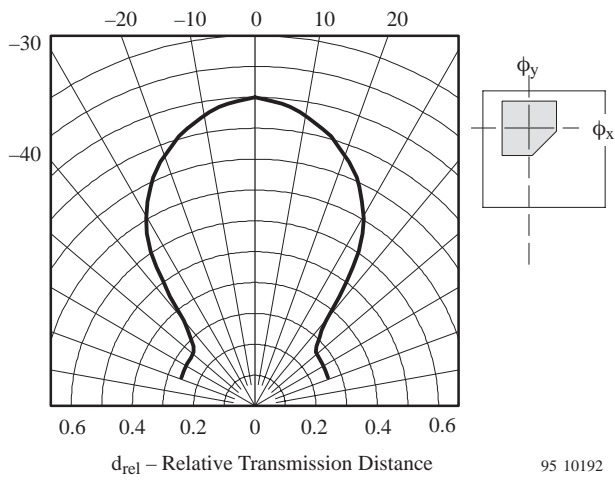

Figure 13. Vertical Directivity  $\phi_y$

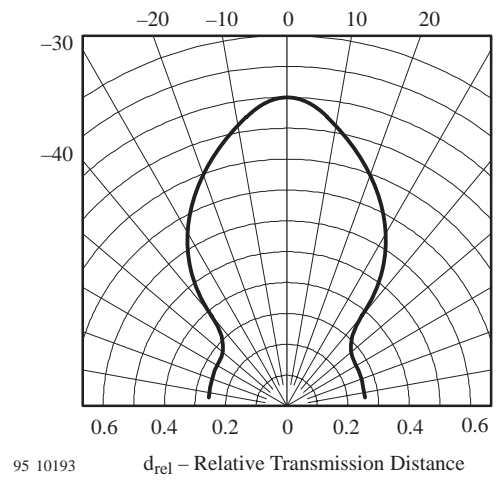
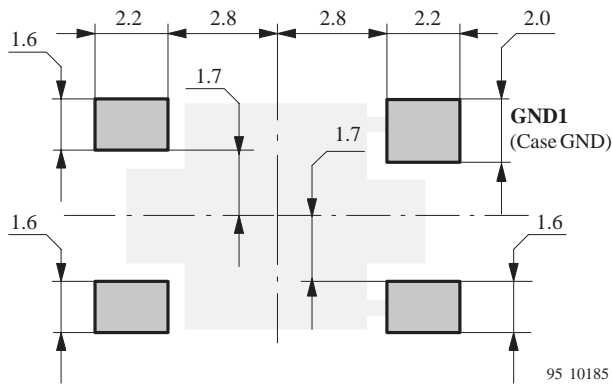

Figure 14. Horizontal Directivity  $\phi_x$

### Soldering Pads for Reflow Soldering



**Note:** Mounting area on the PC board for TFMM.... series has to be solid grounded and has to be insulated by resist.

### Pinning

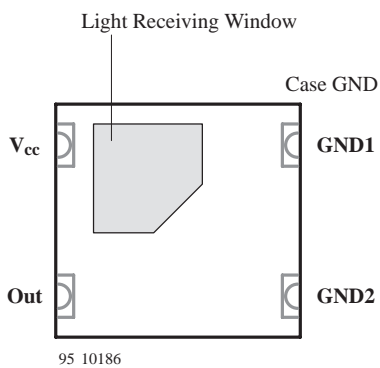

## Dimensions in mm

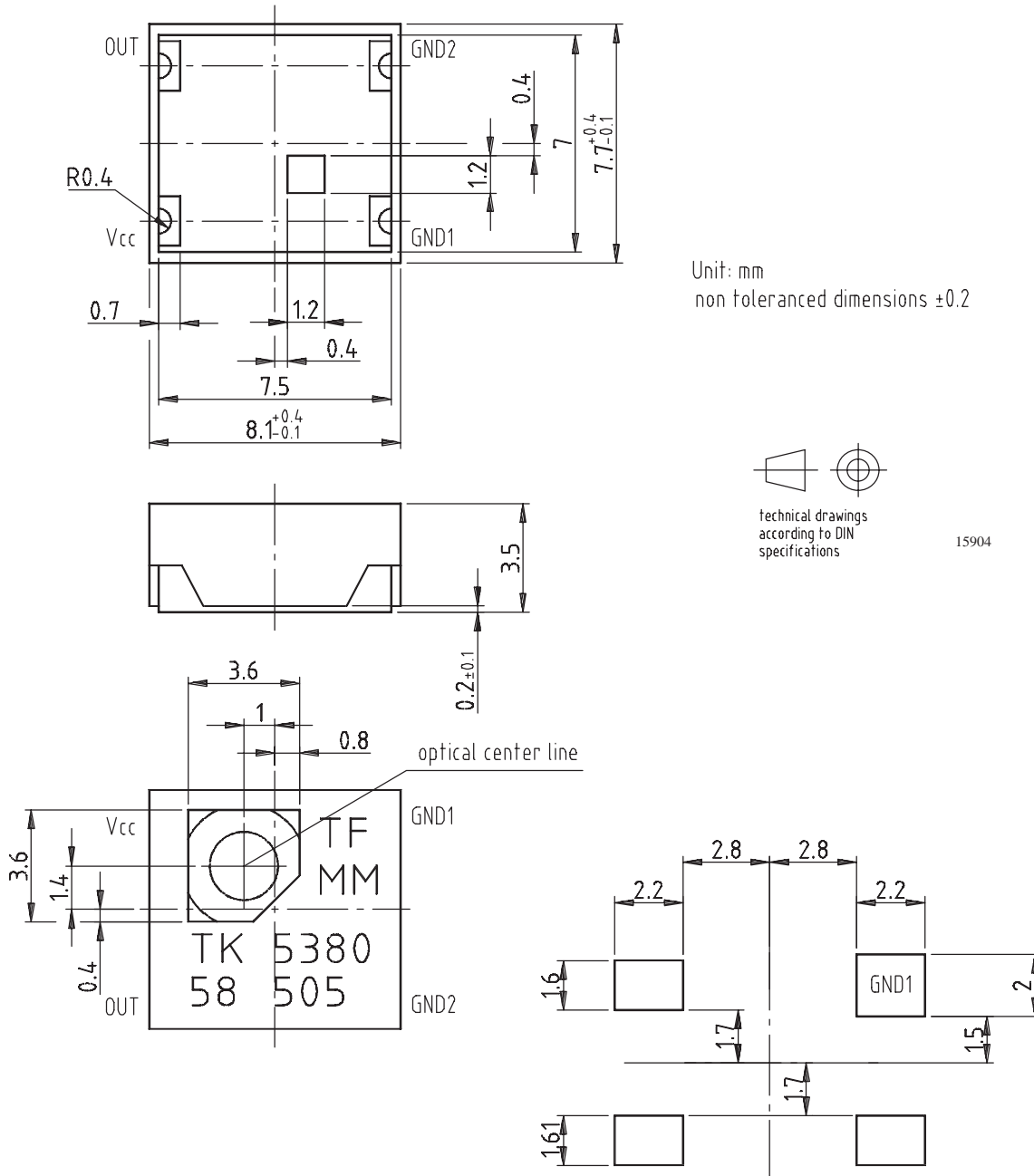

Recommended VISHAY installation pads

## Operating Instructions

### Reflow Soldering

- Reflow soldering must be done within 48 hours stored under max. 30°C, 80% RH after opening envelop
- Recommended soldering paste (composition: SN 63%, Pb 37%)  
Melting temperature 178 to 192°C
- Apply solder paste to the specified soldering pads using a dispenser or by screen printing.
- Recommended thickness of metal mask is 0.2 mm for screen printing.
- The recommended reflow furnace is a combination-type with upper and lower heaters.
- Set the furnace temperatures for pre-heating and heating in accordance with the reflow temperature profile as shown below. Exercise extreme care to keep the maximum temperature below 230°C. The following temperature profile means the temperature at the device surface. Since temperature difference occurs between the work and the surface of the circuit board depending on the position of circuit board or reflow furnace, the operating conditions should be verified prior to start of operation.
- Handling after reflow should be done only after the work surface has been cooled off.

### Manual Soldering

- Use the 6/4 solder or the solder containing silver.
  - Use a soldering iron of 25 W or smaller. Adjust the temperature of the soldering iron below 300°C.
  - Finish soldering within three seconds.
  - Handle products only after the temperature is cooled off.
- ### Cleaning
- Perform cleaning after soldering strictly in conformance to the following conditions:  
Cleaning agent:  
2-propanol (isopropyl alcohol).  
Commercially available grades (industrial use) should be used.  
Demineralized or distilled water having a resistivity of not less than 500 mΩ corresponding to a conductivity of 2 mS/m.
  - Temperature and time: 30 seconds under the temperature below 50°C or 3 minutes below 30°C.
  - Ultrasonic cleaning: Below 20 W.

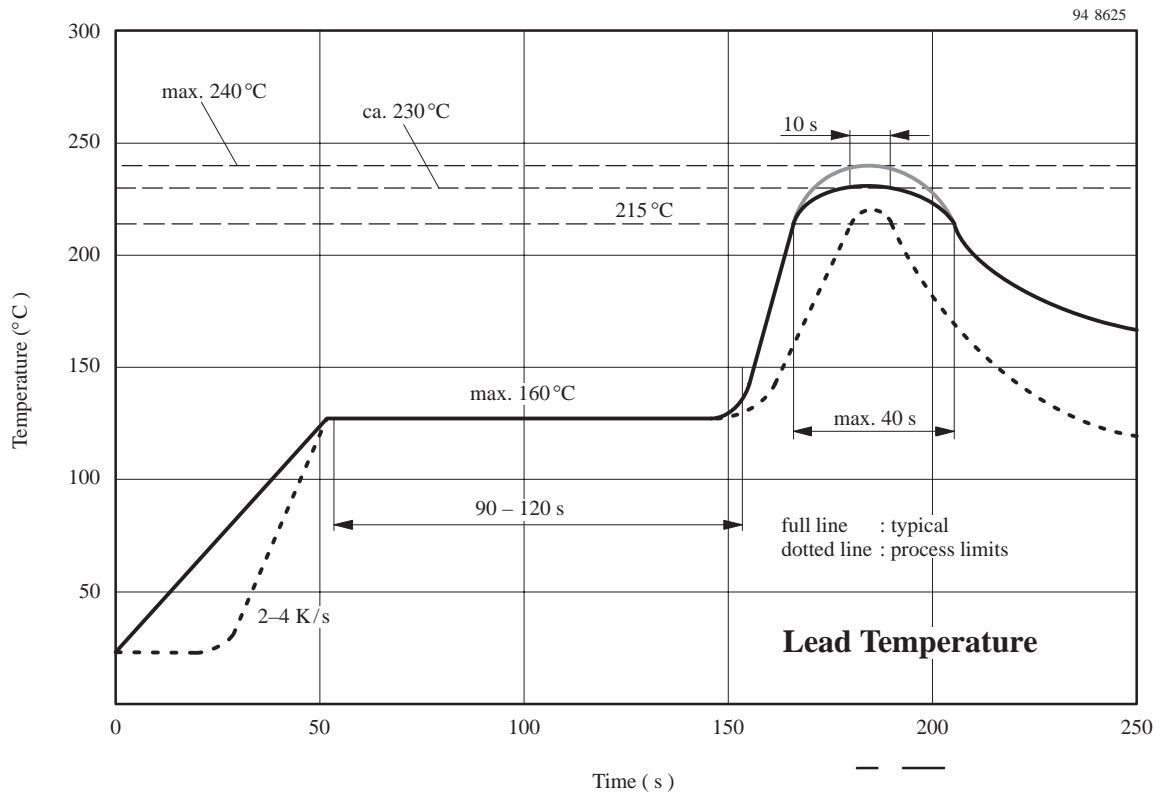

Taping Specifications

(1) Shape and dimensions of reels (in accordance with EIAJRC-1009B); unit in mm

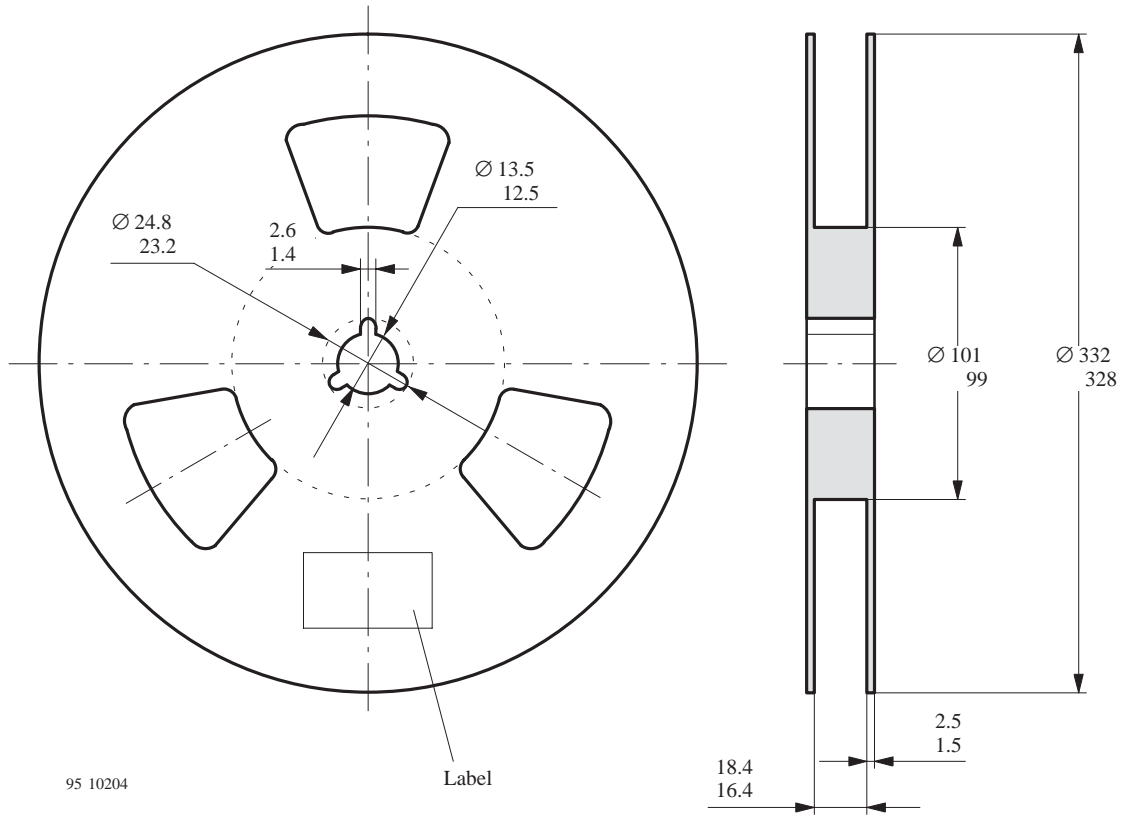

(2) Dimensions of tape

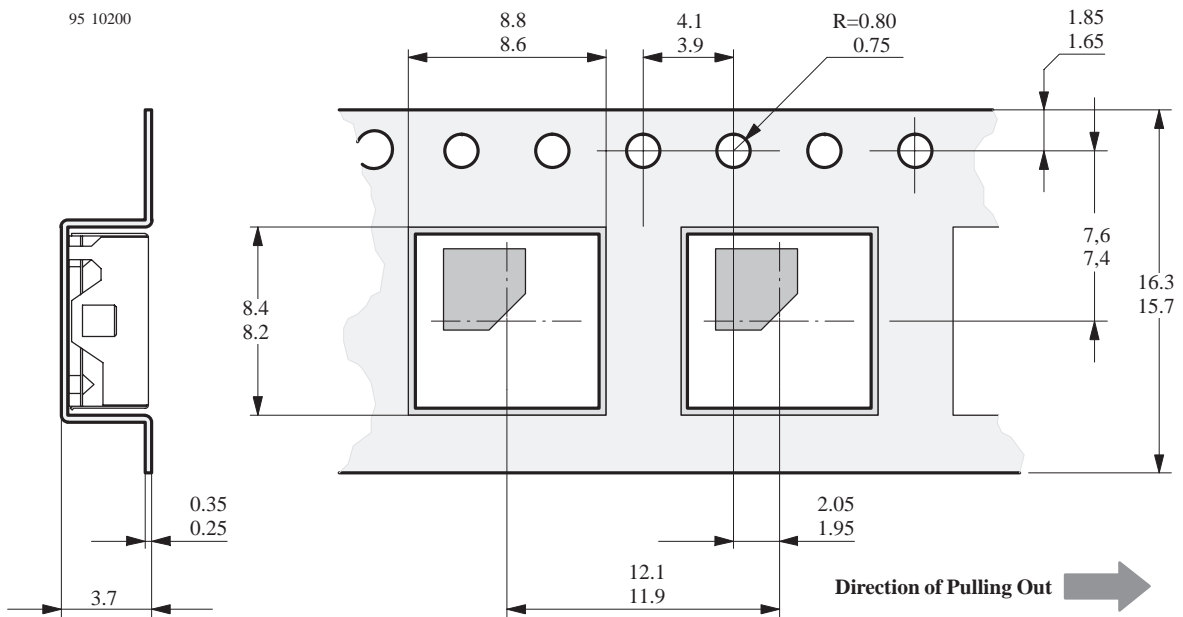



**(3) Configuration of tapes**

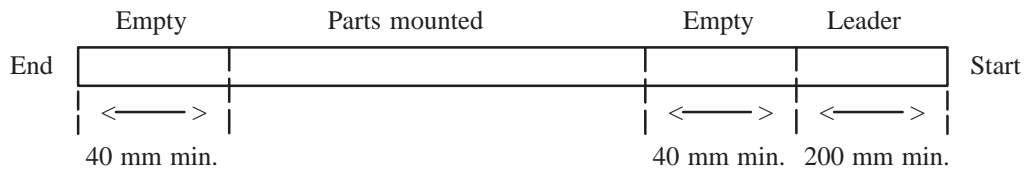

**(4) Quantity**

1000 pcs. per reel

**Packing**

**(1) Dampproof packing**

Products will be packed in anti-humidity aluminium bags to prevent the products from moisture absorption during transportation and storage. Each bag contains

a desiccant with moisture indicators. In the event bags absorb moisture, the indicators change their color from blue to pink.

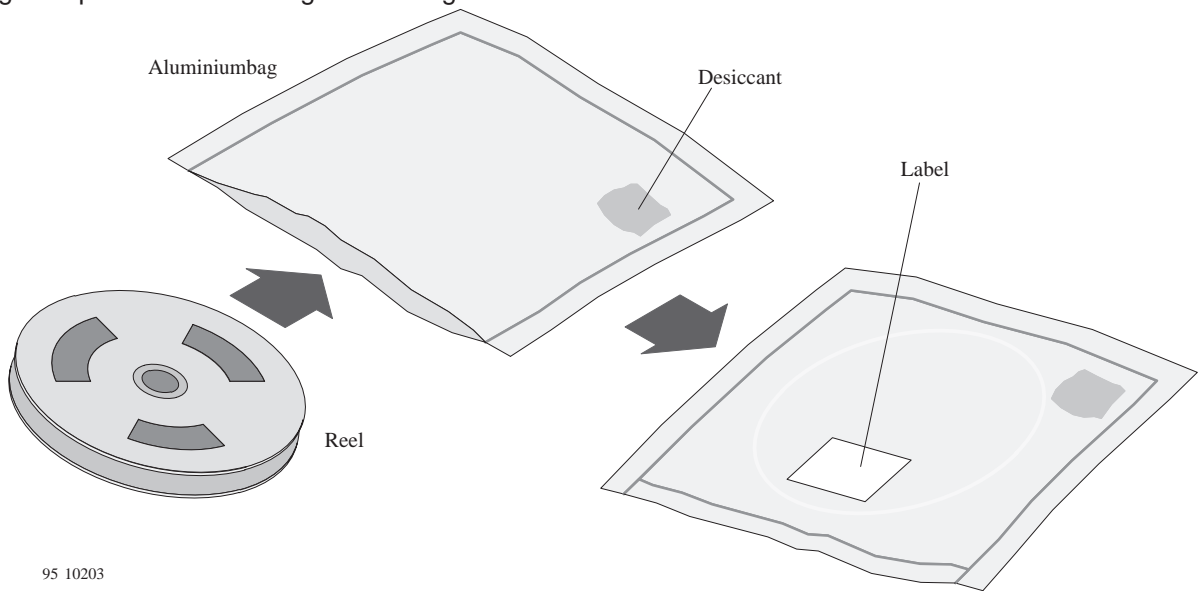

**(2) Recommended method of storage**

Dry box storage is recommended to prevent the parts from moisture absorption. The following conditions

should be preserved if dry boxes are not available.

Storage temperature: 10 – 30°C

Storage humidity: 60% RH max

In case of moisture absorption the device will recover to the former condition by drying under the following recommended conditions:

taped version: 60°C/48 h

untaped version: 125°C/2 h

**Lot Number**

3 digits

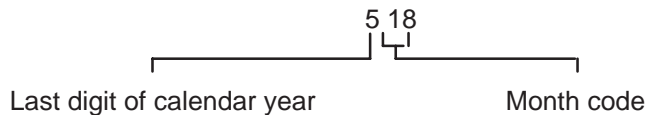

Lot number is labeled on the aluminum bag and also indicated on the reverse side of each part.



### Ozone Depleting Substances Policy Statement

It is the policy of **Vishay Semiconductor GmbH** to

1. Meet all present and future national and international statutory requirements.
2. Regularly and continuously improve the performance of our products, processes, distribution and operating systems with respect to their impact on the health and safety of our employees and the public, as well as their impact on the environment.

It is particular concern to control or eliminate releases of those substances into the atmosphere which are known as ozone depleting substances (ODSs).

The Montreal Protocol (1987) and its London Amendments (1990) intend to severely restrict the use of ODSs and forbid their use within the next ten years. Various national and international initiatives are pressing for an earlier ban on these substances.

**Vishay Semiconductor GmbH** has been able to use its policy of continuous improvements to eliminate the use of ODSs listed in the following documents.

1. Annex A, B and list of transitional substances of the Montreal Protocol and the London Amendments respectively
2. Class I and II ozone depleting substances in the Clean Air Act Amendments of 1990 by the Environmental Protection Agency (EPA) in the USA
3. Council Decision 88/540/EEC and 91/690/EEC Annex A, B and C (transitional substances) respectively.

**Vishay Semiconductor GmbH** can certify that our semiconductors are not manufactured with ozone depleting substances and do not contain such substances.

**We reserve the right to make changes to improve technical design and may do so without further notice.**

Parameters can vary in different applications. All operating parameters must be validated for each customer application by the customer. Should the buyer use Vishay-Telefunken products for any unintended or unauthorized application, the buyer shall indemnify Vishay-Telefunken against all claims, costs, damages, and expenses, arising out of, directly or indirectly, any claim of personal damage, injury or death associated with such unintended or unauthorized use.

Vishay Semiconductor GmbH, P.O.B. 3535, D-74025 Heilbronn, Germany  
Telephone: 49 (0)7131 67 2831, Fax number: 49 (0)7131 67 2423