

Complementary 30-V (D-S) MOSFET

PRODUCT SUMMARY			
	V_{DS} (V)	$r_{DS(on)}$ (Ω)	I_D (A)
P-Channel	-30	0.051 @ $V_{GS} = -10$ V	-6.4
		0.075 @ $V_{GS} = -6$ V	-5.3
N-Channel	30	0.035 @ $V_{GS} = 10$ V	7.7
		0.050 @ $V_{GS} = 4.5$ V	6.5

FEATURES

- TrenchFET® Power MOSFET
- New Low Thermal Resistance PowerPAK® Package with Low 1.07-mm Profile

APPLICATIONS

- Backlight Inverter
- DC/DC Converter
 - 4-Cell Battery

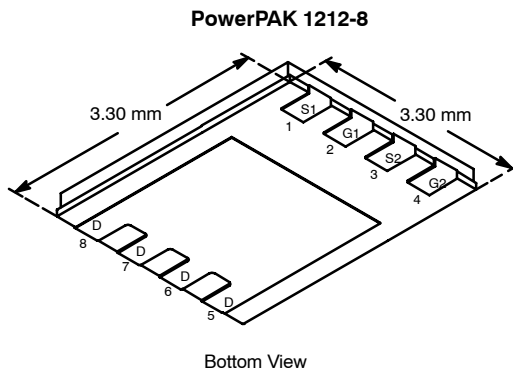

Bottom View

Ordering Information: Si7501DN-T1—E3

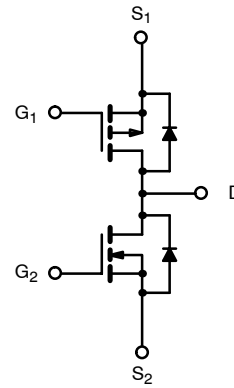

ABSOLUTE MAXIMUM RATINGS ($T_A = 25^\circ\text{C}$ UNLESS OTHERWISE NOTED)

Parameter	Symbol	P-Channel		N-Channel		Unit
		10 secs	Steady State	10 secs	Steady State	
Drain-Source Voltage	V_{DS}	-30		30		V
Gate-Source Voltage	V_{GS}	± 25		± 20		V
Continuous Drain Current ($T_J = 150^\circ\text{C}$) ^a	$T_A = 25^\circ\text{C}$	-6.4	-4.5	7.7	5.4	A
	$T_A = 70^\circ\text{C}$	-5.1	-3.6	4.7	4.3	
Pulsed Drain Current	I_{DM}	-25		25		A
Continuous Source Current (Diode Conduction) ^a	I_S	-2.6	-1.3	2.6	1.3	A
Maximum Power Dissipation ^a	$T_A = 25^\circ\text{C}$	3.1	1.6	3.1	1.6	W
	$T_A = 70^\circ\text{C}$	3	1.0	2	1.0	
Operating Junction and Storage Temperature Range	T_J, T_{stg}	-55 to 150				$^\circ\text{C}$

THERMAL RESISTANCE RATINGS

Parameter	Symbol	Typical	Maximum	Unit
Maximum Junction-to-Ambient ^a	$t \leq 10$ sec	32	40	$^\circ\text{C}/\text{W}$
	Steady State	65	81	
Maximum Junction-to-Foot (Case)	Steady State	5	6.3	

Notes

a. Surface Mounted on 1" x 1" FR4 Board.

SPECIFICATIONS (T _J = 25 °C UNLESS OTHERWISE NOTED)							
Parameter	Symbol	Test Condition		Min	Typ	Max	Unit
Static							
Gate Threshold Voltage	V _{GS(th)}	V _{DS} = V _{GS} , I _D = -250 μA	P-Ch	-1.0		-3	V
		V _{DS} = V _{GS} , I _D = 250 μA	N-Ch	1.0		3	
Gate-Body Leakage	I _{GSS}	V _{DS} = 0 V, V _{GS} = ±25 V	P-Ch			±200	nA
		V _{DS} = 0 V, V _{GS} = ±20 V	N-Ch			±100	
Zero Gate Voltage Drain Current	I _{DSS}	V _{DS} = -30 V, V _{GS} = 0 V	P-Ch			-1	μA
		V _{DS} = 30 V, V _{GS} = 0 V	N-Ch			1	
		V _{DS} = -30 V, V _{GS} = 0 V, T _J = 55 °C	P-Ch			-5	
		V _{DS} = 30 V, V _{GS} = 0 V, T _J = 55 °C	N-Ch			5	
On-State Drain Current ^a	I _{D(on)}	V _{DS} ≥ -5 V, V _{GS} = -10 V	P-Ch	-25			A
		V _{DS} ≤ 5 V, V _{GS} = 10 V	N-Ch	25			
Drain-Source On-State Resistance ^a	r _{DS(on)}	V _{GS} = -10 V, I _D = -6.4 A	P-Ch		0.041	0.051	Ω
		V _{GS} = 10 V, I _D = 7.7 A	N-Ch		0.028	0.035	
		V _{GS} = -6 V, I _D = -5.3 A	P-Ch		0.055	0.075	
		V _{GS} = 4.5 V, I _D = 6.5 A	N-Ch		0.040	0.050	
Forward Transconductance ^a	g _{fs}	V _{DS} = -15 V, I _D = -6.4 A	P-Ch		13		S
		V _{DS} = 15 V, I _D = 7.7 A	N-Ch		15		
Diode Forward Voltage ^a	V _{SD}	I _S = -1.7 A, V _{GS} = 0 V	P-Ch		-0.80	-1.2	V
		I _S = 1.7 A, V _{GS} = 0 V	N-Ch		0.80	1.2	
Dynamic^b							
Total Gate Charge	Q _g	P-Channel V _{DS} = -15 V, V _{GS} = -10 V, I _D = -6.4 A N-Channel V _{DS} = 15 V, V _{GS} = 10 V, I _D = 7.7 A	P-Ch		12.5	19	nC
			N-Ch		9	14	
Gate-Source Charge	Q _{gs}		P-Ch		2.5		
			N-Ch		2		
Gate-Drain Charge	Q _{gd}		P-Ch		3.6		
			N-Ch		1.3		
Gate Resistance	R _g	P-Ch		9		Ω	
		N-Ch		3			
Turn-On Delay Time	t _{d(on)}	P-Ch		10	15	ns	
		N-Ch		10	15		
Rise Time	t _r	P-Ch		20	30		
		N-Ch		15	25		
Turn-Off Delay Time	t _{d(off)}	P-Ch		25	40		
		N-Ch		20	30		
Fall Time	t _f	P-Ch		30	45		
		N-Ch		10	15		
Source-Drain Reverse Recovery Time	t _{rr}	I _F = -1.7 A, di/dt = 100 A/μs	P-Ch		25	50	
		I _F = 1.7 A, di/dt = 100 A/μs	N-Ch		20	40	

Notes

- a. Pulse test; pulse width ≤ 300 μs, duty cycle ≤ 2%.
 b. Guaranteed by design, not subject to production testing.



TYPICAL CHARACTERISTICS (25°C UNLESS NOTED)

P-CHANNEL

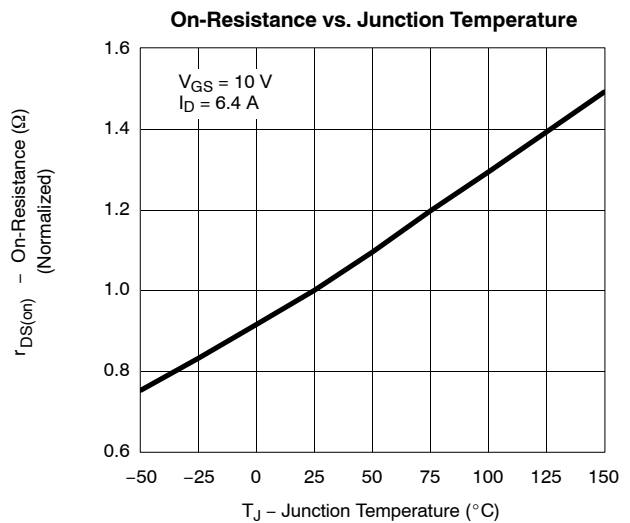
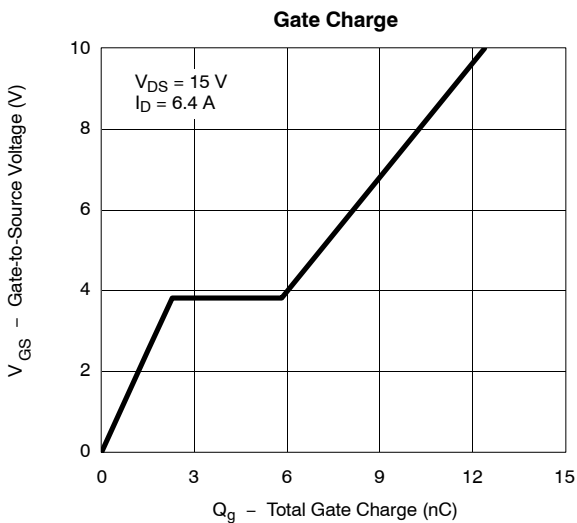
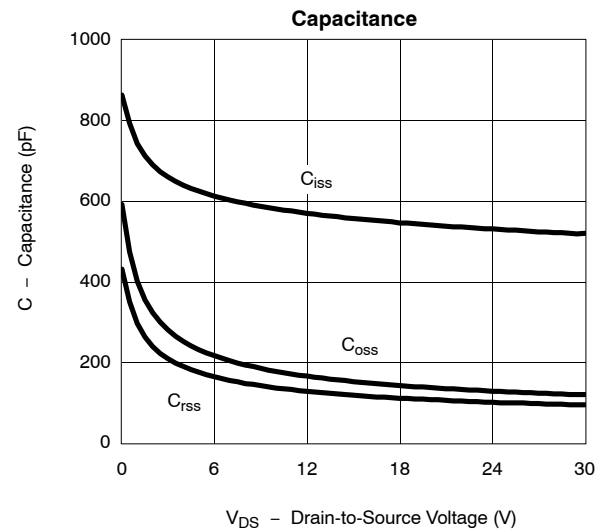
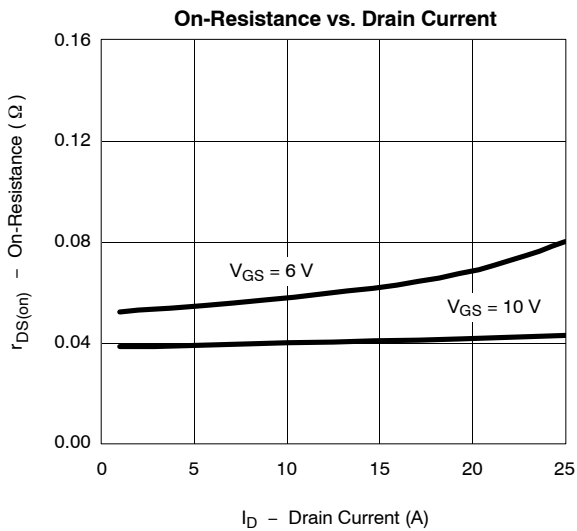
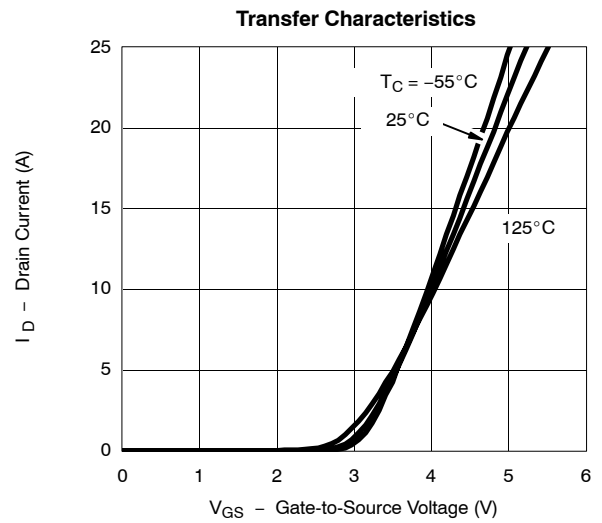
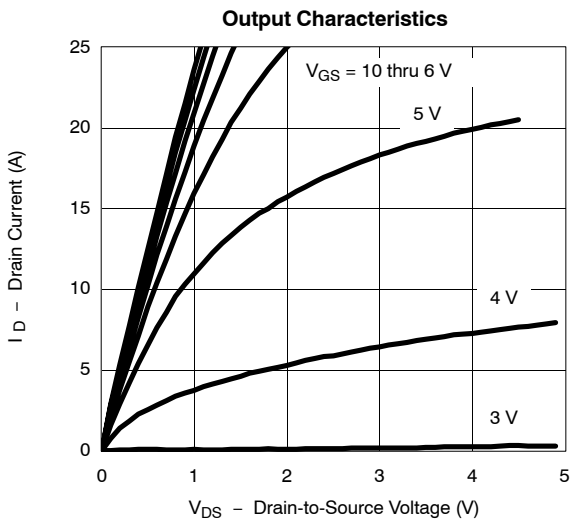

TYPICAL CHARACTERISTICS (25 °C UNLESS NOTED) P-CHANNEL

Source-Drain Diode Forward Voltage

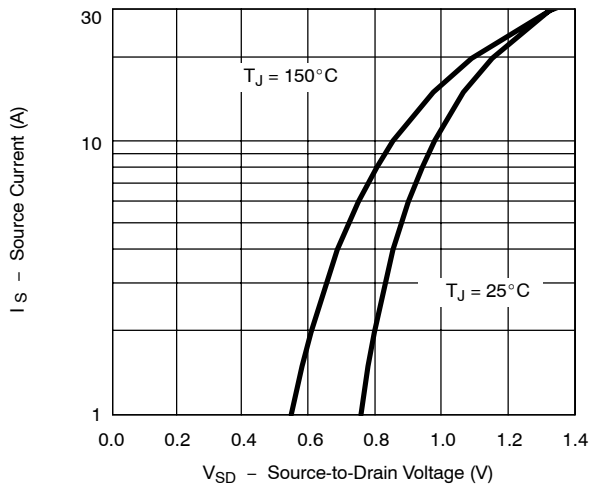

On-Resistance vs. Gate-to-Source Voltage

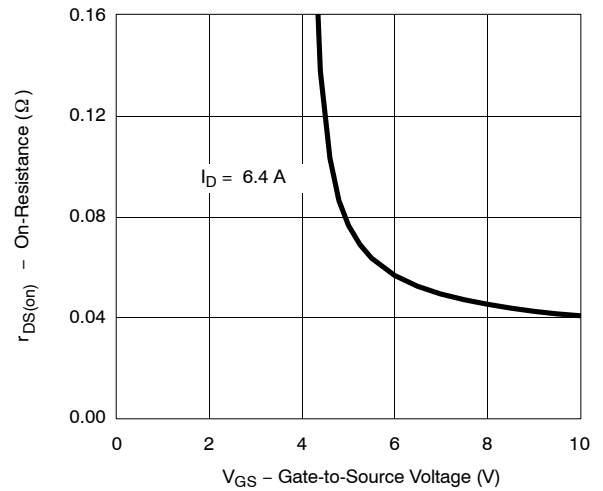

Threshold Voltage

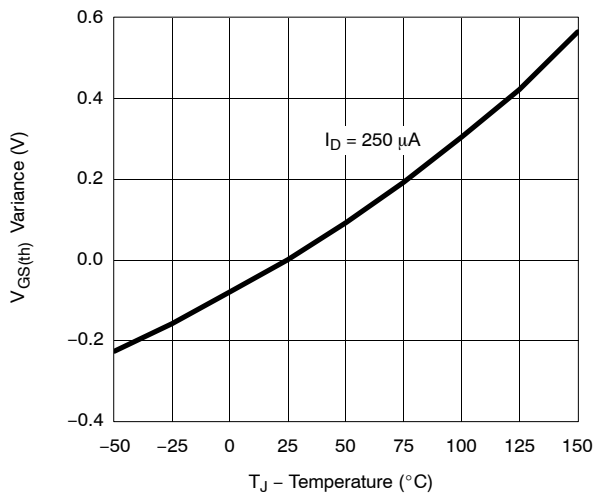

Single Pulse Power

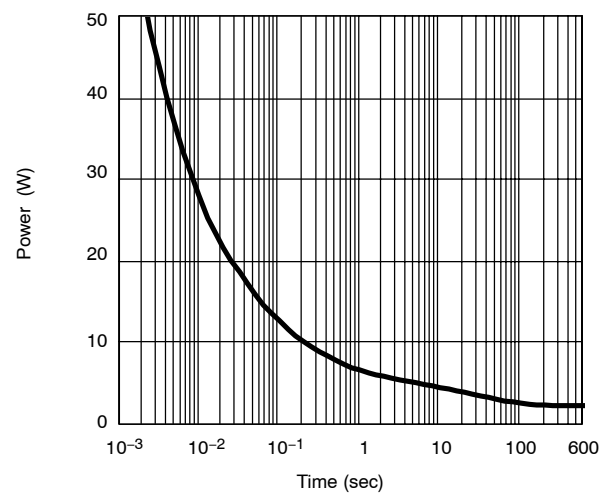

Safe Operating Area

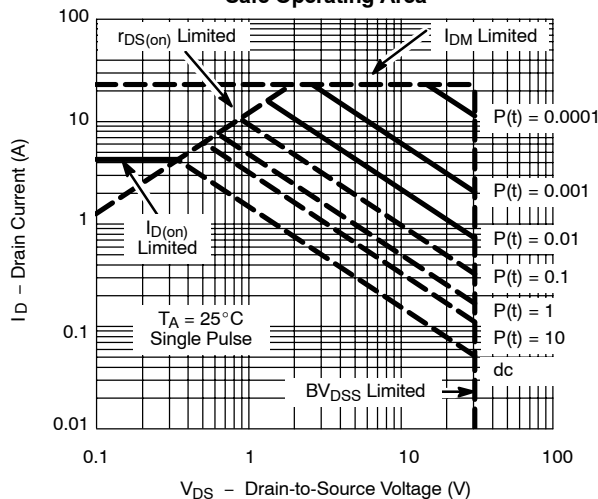



TYPICAL CHARACTERISTICS (25°C UNLESS NOTED)

P-CHANNEL

Normalized Thermal Transient Impedance, Junction-to-Ambient

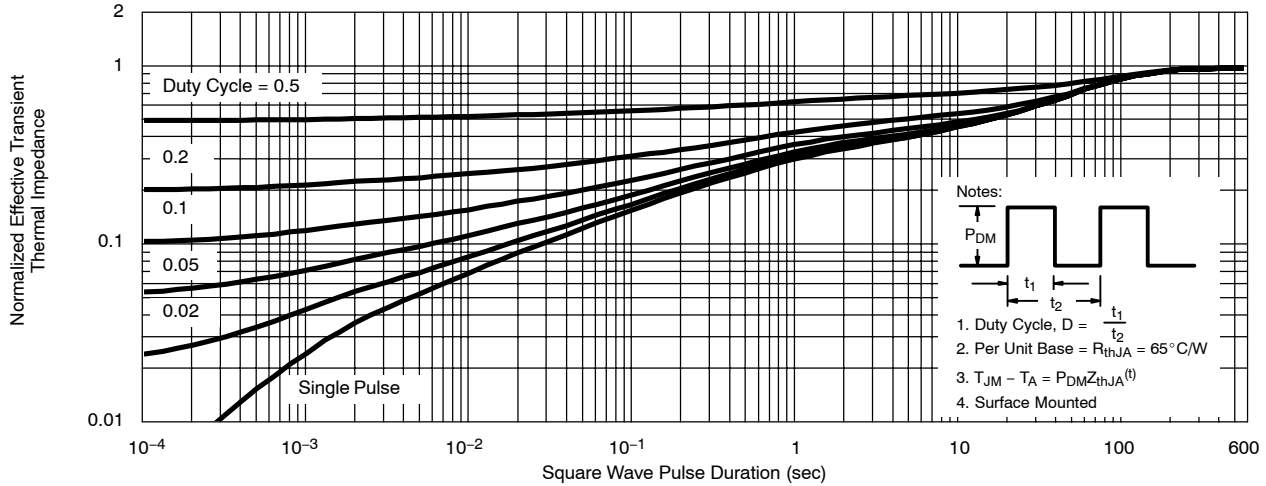

Normalized Thermal Transient Impedance, Junction-to-Case

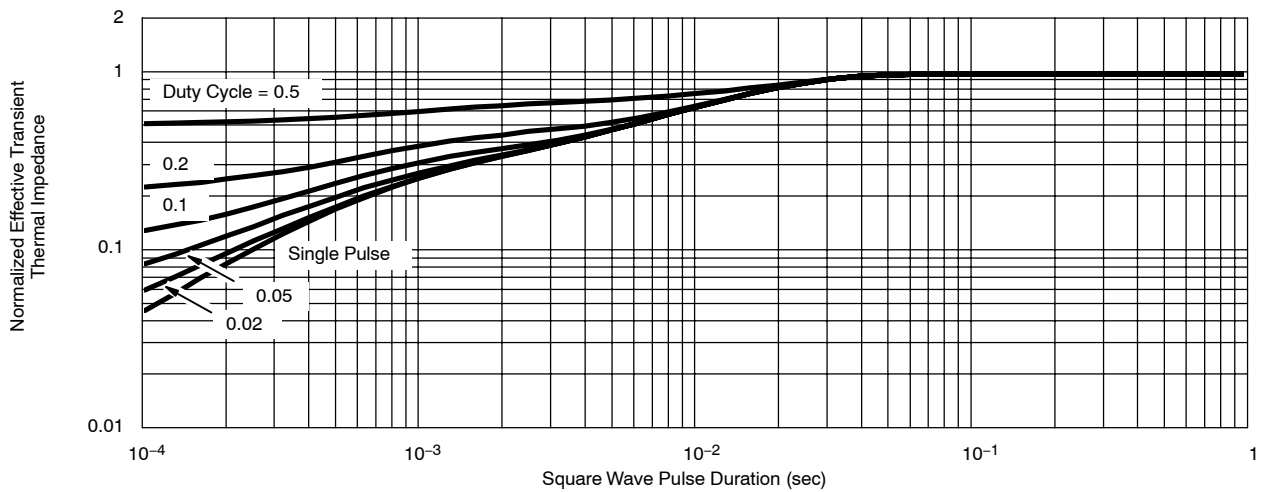

TYPICAL CHARACTERISTICS (25 °C UNLESS NOTED) N-CHANNEL

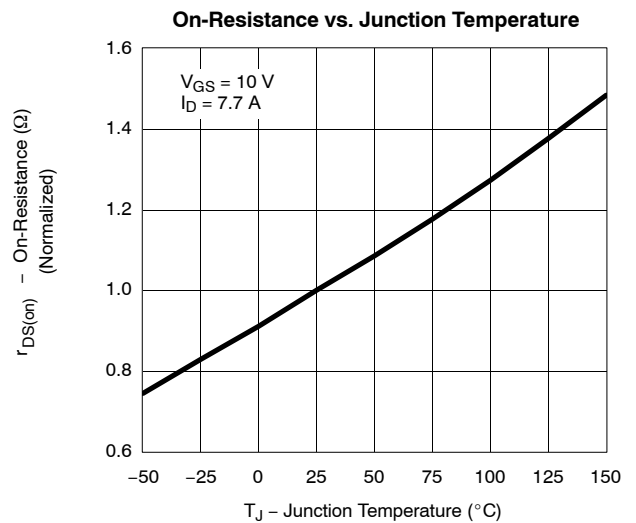
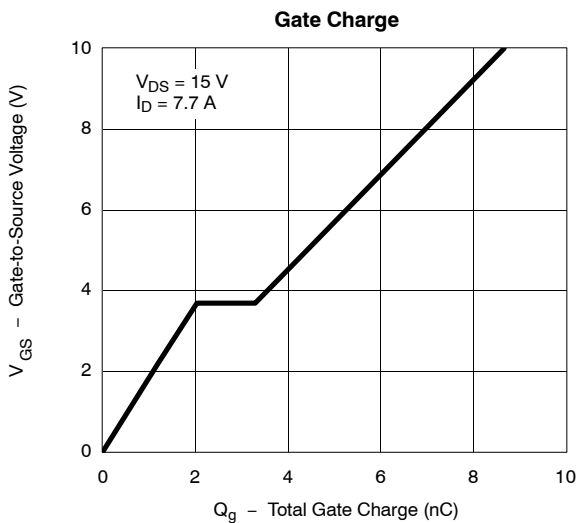
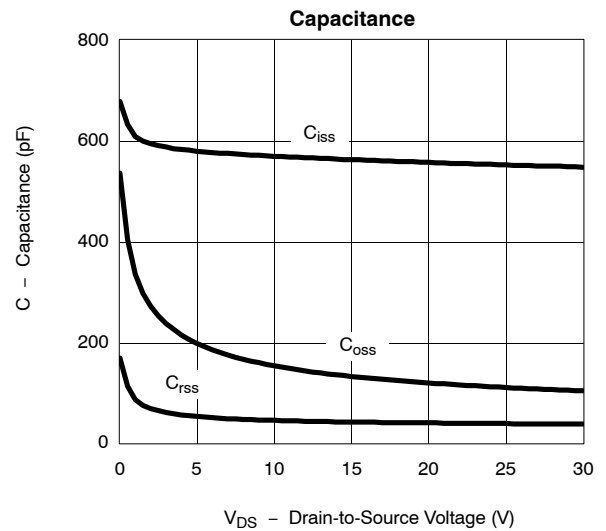
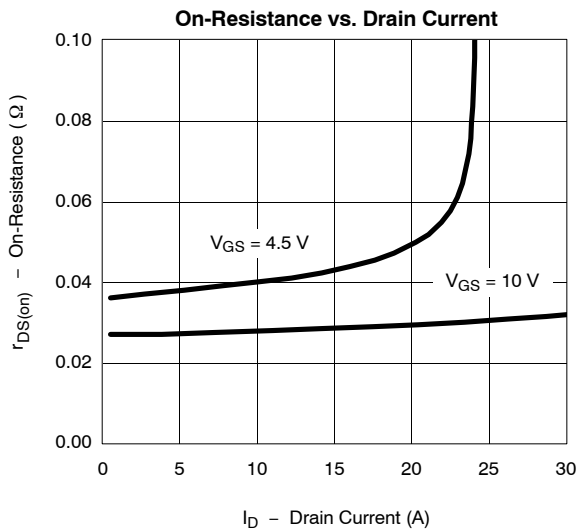
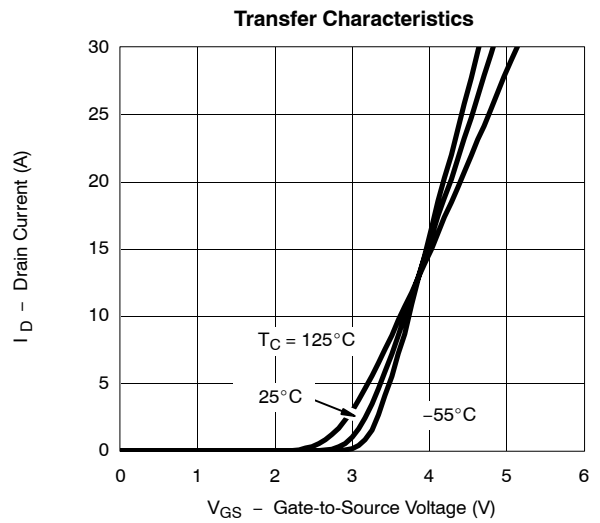
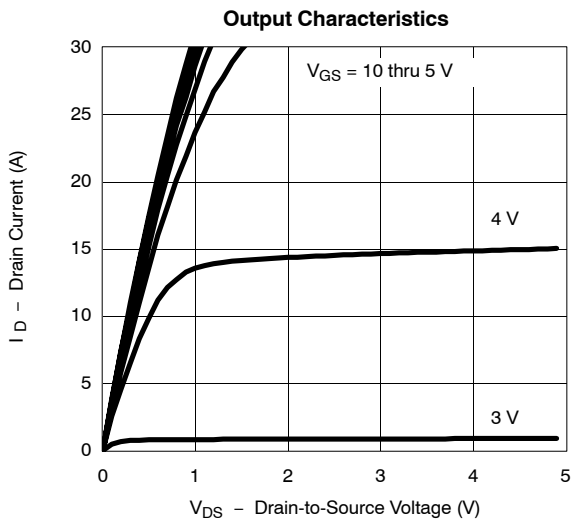



TYPICAL CHARACTERISTICS (25°C UNLESS NOTED)

N-CHANNEL

Source-Drain Diode Forward Voltage

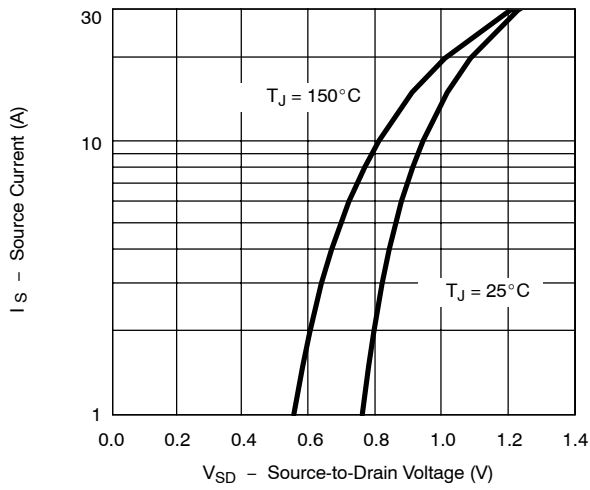

On-Resistance vs. Gate-to-Source Voltage

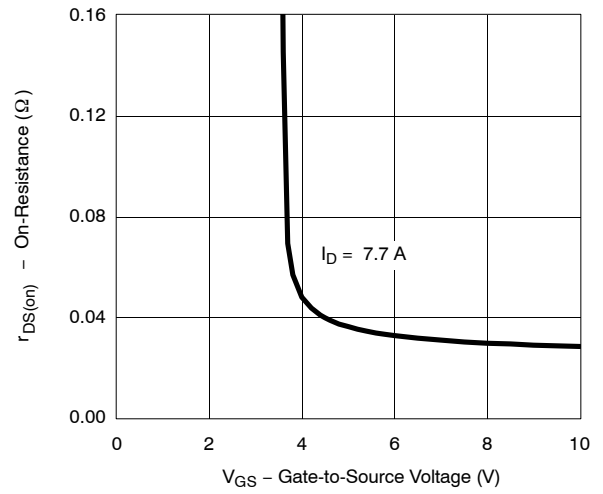

Threshold Voltage

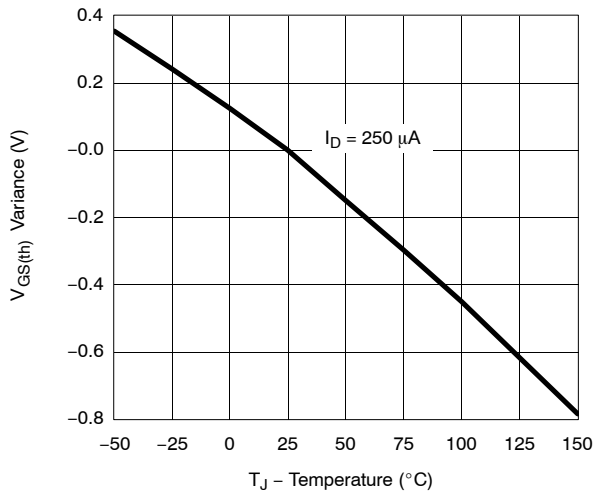

Single Pulse Power

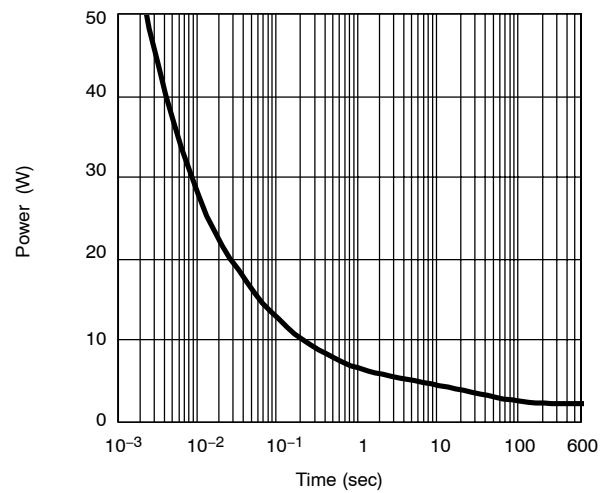

Safe Operating Area

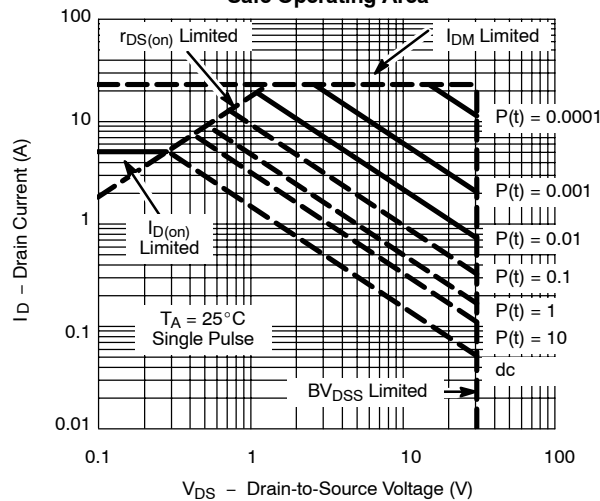

TYPICAL CHARACTERISTICS (25 °C UNLESS NOTED) N-CHANNEL

Normalized Thermal Transient Impedance, Junction-to-Ambient

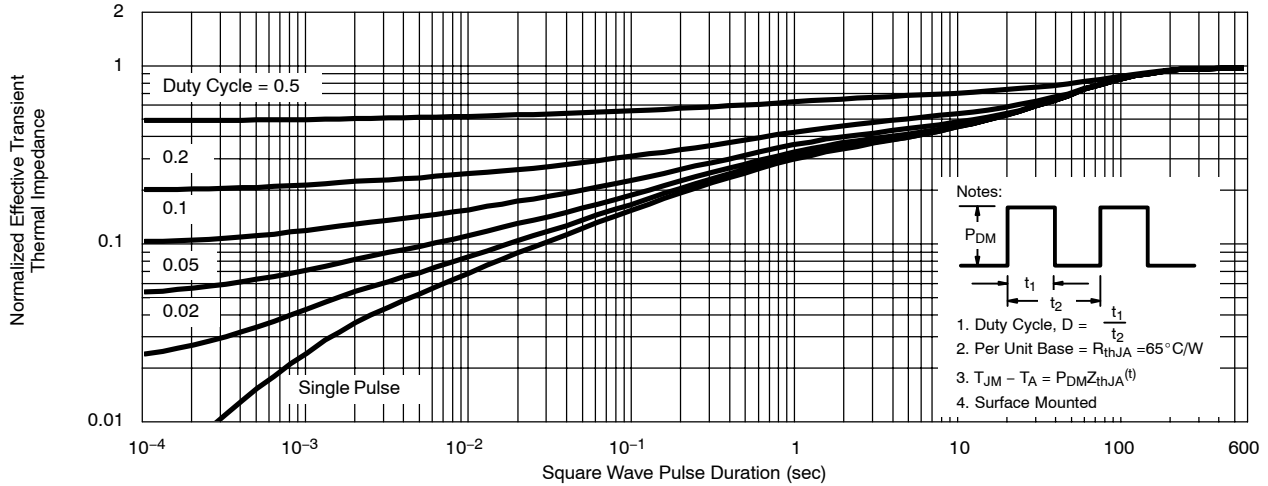

Normalized Thermal Transient Impedance, Junction-to-Case

