

TOSHIBA BIPOLAR LINEAR INTEGRATED CIRCUIT SILICON MONOLITHIC

TA7343AP**FM PLL MPX**

The TA7343AP is PLL FM stereo multiplex IC.
It is suitable for automotive applications and portable radio applications because of space merit by the package and wide supply voltage range.

FEATURES

- Excellent stereo LED sensitivity
: $V_L(ON) = 9mV_{rms}$ (Typ.)
- Suitable for LED driving : $I_{LED} = 20mA$ (Max.)
- Recommendable input voltage range
: $V_{in} = 200\sim 700mV_{rms}$
- Operating supply voltage range : $V_{CC} = 3.5\sim 12V$
- Excellent channel separation through
entire audio frequency range : $Sep = 45dB$ (Typ.)
- Low distortion : $THD = 0.08\%$ (Typ.) at $V_{in} = 200mV_{rms}$ (Stereo)
- Built-in compulsive monaural function. (The VCO is stopped when the pin⑦ is connected with the power supply line, and then the stereo indicator is turn off.)
- Easy adjustment (The monitored free running frequency of VCO is 38kHz at pin⑥.)

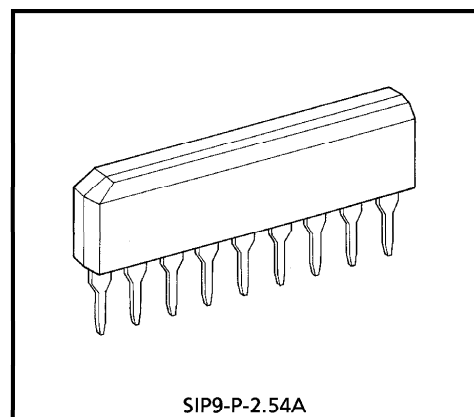

SIP9-P-2.54A
Weight : 0.92g (Typ.)

961001EBA2

- TOSHIBA is continually working to improve the quality and the reliability of its products. Nevertheless, semiconductor devices in general can malfunction or fail due to their inherent electrical sensitivity and vulnerability to physical stress. It is the responsibility of the buyer, when utilizing TOSHIBA products, to observe standards of safety, and to avoid situations in which a malfunction or failure of a TOSHIBA product could cause loss of human life, bodily injury or damage to property. In developing your designs, please ensure that TOSHIBA products are used within specified operating ranges as set forth in the most recent products specifications. Also, please keep in mind the precautions and conditions set forth in the TOSHIBA Semiconductor Reliability Handbook.
- The products described in this document are subject to foreign exchange and foreign trade control laws.
- The information contained herein is presented only as a guide for the applications of our products. No responsibility is assumed by TOSHIBA CORPORATION for any infringements of intellectual property or other rights of the third parties which may result from its use. No license is granted by implication or otherwise under any intellectual property or other rights of TOSHIBA CORPORATION or others.
- The information contained herein is subject to change without notice.

BLOCK DIAGRAM

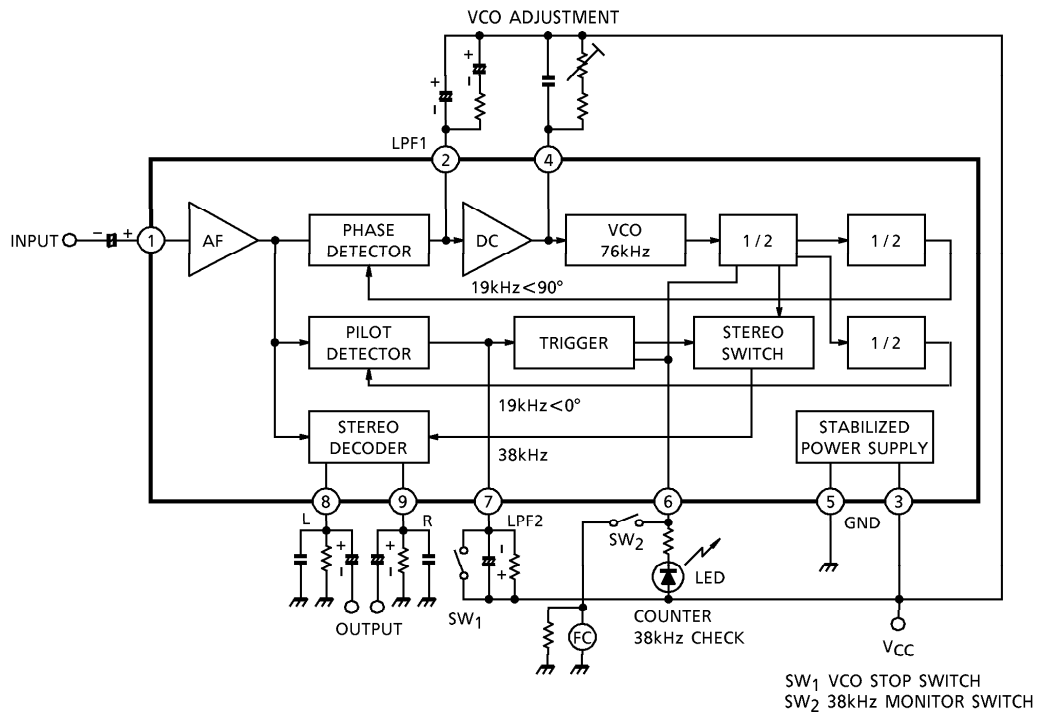

MAXIMUM RATINGS (Ta = 25°C)

CHARACTERISTIC	SYMBOL	RATING	UNIT
Supply Voltage	V _{CC}	12	V
LED Voltage	V _{LED}	16	V
LED Current	I _{LED}	20	mA
Power Dissipation	P _D (Note)	500	mW
Operating Temperature	T _{opr}	-30~75	°C
Storage Temperature	T _{stg}	-55~155	°C

(Note) Derated above Ta = 25°C in the proportion of 4mW/°C.

ELECTRICAL CHARACTERISTICS

1. DC characteristics (Ta = 25°C, V_{CC} = 8V, terminal voltage at no signal)

PIN No.	CHARACTERISTIC	SYMBOL	TYP.	UNIT
Pin①	INPUT	V1	3.5	V
Pin②	LPF 1	V2	6.6	V
Pin③	V _{CC}	V3	8.0	V
Pin④	VCO	V4	7.1	V
Pin⑤	GND	V5	0	V
Pin⑥	ST LED	V6	—	V
Pin⑦	LPF 2	V7	7.4	V
Pin⑧	L-ch OUTPUT	V8	4.0	V
Pin⑨	R-ch OUTPUT	V9	4.0	V

2. AC characteristics (Unless otherwise specified, $T_a = 25^\circ\text{C}$, $V_{CC} = 8\text{V}$, $f = 1\text{kHz}$)

CHARACTERISTIC		SYMBOL	TEST CIRCUIT	TEST CONDITION	MIN.	TYP.	MAX.	UNIT	
Supply Current		I_{CC}	—	at LED off	—	11	18	mA	
Input Resistance		R_{IN}	—		—	33	—	$k\Omega$	
Max. Composite Signal Input Voltage		V_{in} MAX (STEREO)	—	L + R = 90%, P = 10% THD = 1%	—	900	—	mV_{rms}	
Separation		Sep	—	L + R = 180 mV_{rms} P = 20 mV_{rms}	36	45	—	dB	
Total Harmonic Distortion	Monaural	THD (MONAURAL)	—	$V_{in} = 200mV_{rms}$	—	0.08	0.3	%	
	Stereo	THD (STEREO)	—	L + R = 180 mV_{rms} P = 20 mV_{rms}	—	0.08	—		
Voltage Gain		G_V	—	$V_{in} = 200mV_{rms}$	-2.0	0	2.0	dB	
Channel Balance		CB	—	$V_{in} = 200mV_{rms}$	—	0	1.5	dB	
Stereo LED Sensitivity	ON	V_L (ON)	—	Pilot Input	—	9	15	mV_{rms}	
	OFF	V_L (OFF)	—		2	6	—		
Stereo LED Hysteresis		V_H	—	to turn off from LED turn on	—	3	—	mV_{rms}	
Capture Range		CR	—	P = 20 mV_{rms}	—	± 3	—	%	
Carrier Leak	19kHz	CL	—	P = 20 mV_{rms} L + R = 180 mV_{rms}	—	34	—	dB	
	38kHz				—	42	—		
SCA Rejection Ratio		SCA Rej	—	P = 20 mV_{rms} L + R = 160 mV_{rms} SCA = 20 mV_{rms} $f_{SCA} = 67\text{kHz}$	—	70	—	dB	
Signal to Noise Ratio		S / N	—	$V_{in} = 200mV_{rms}$ $f = 1\text{kHz}$, $R_g = 620\Omega$	—	74	—	dB	
Output Current (Pin⑧, Pin⑨)		I_{OUT}	—	$R_L = 3.3k\Omega$	$V_{CC} = 3.5\text{V}$	—	0.3	0.6	mA
					$V_{CC} = 8.0\text{V}$	—	1.2	1.8	
					$V_{CC} = 12\text{V}$	—	1.4	2.1	

TEST CIRCUIT

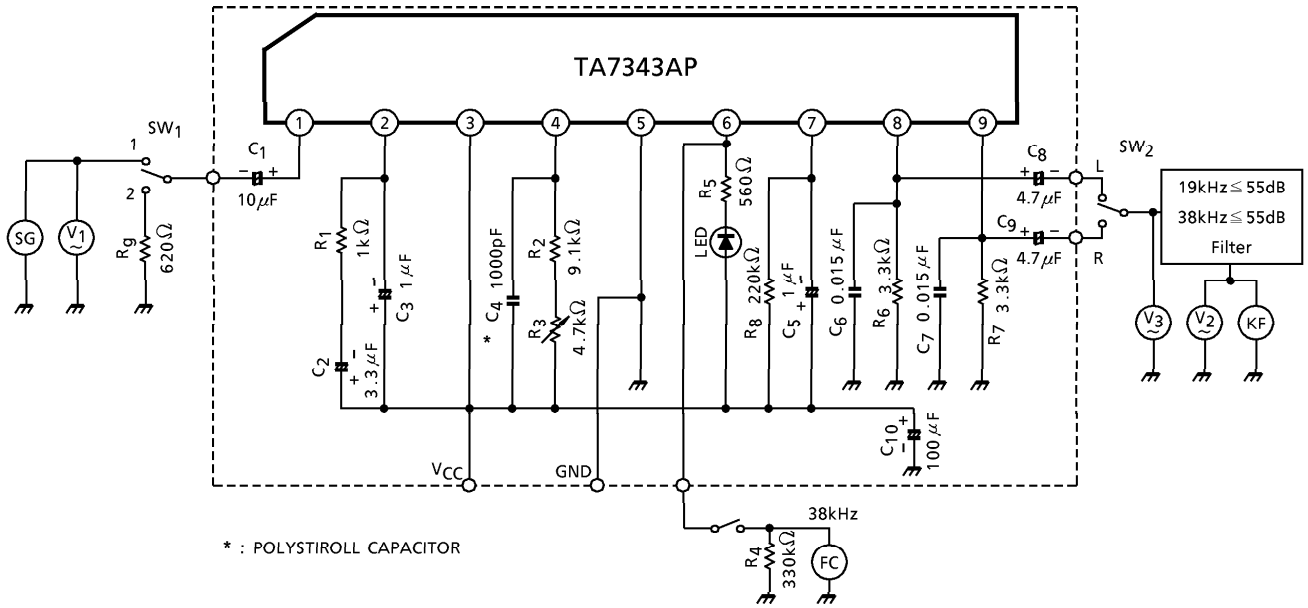

* : POLYSTIROLL CAPACITOR

- SG : STEREO SIGNAL GENERATOR
- FC : FREQUENCY COUNTER
- V₁, V₂, V₃ : AC VOLTMETER
- KF : DISTORTION METER

EXTERNAL PARTS TABLE

PARTS No.	TYPICAL	PURPOSE	INFLUENCE		NOTE
			SMALLER THAN TYP.	GREATER THAN TYP.	
C ₁	10 μ F	Coupling	Separation is bad at 50~300Hz	"POP" noise is high	Input
C ₂	3.3 μ F	LPF at PLL	THD is bad at 5~10kHz (stereo)	Narrow capture range	—
C ₃	1 μ F				
R ₁	1k Ω				
C ₄	1000pF	VCO Free Running	C ₄ : Small→Wide capture range and large glitter C ₄ : Large→Narrow capture range	—	—
R ₂	9.1k Ω	Frequency adjustment			
R ₃	4.7k Ω VR				
R ₄	330k Ω	Monitor Load	—	—	—
R ₅	560 Ω	Rush Current Limiter	IC is damaged by the rush current	LED is dark	I _{LED} \leq 20mA
LED	—	Stereo Indicator	Usable for LED		
C ₆	0.015 μ F	Load and Diemphasis	Diemphasis (50 μ s)		C ₆ = 0.022 μ F for 75 μ s
R ₆	3.3k Ω		Output voltage is small	THD is bad for low V _{CC}	
C ₇	0.015 μ F	Load and Diemphasis	Diemphasis (50 μ s)		C ₇ = 0.022 μ F for 75 μ s
R ₇	3.3k Ω		Output voltage is small	THD is bad for low V _{CC}	
C ₈	4.7 μ F	Output Coupling	Frequency response is bad	"POP" noise is large	L-ch
C ₉	4.7 μ F	Output Coupling			R-ch
R ₈	220k Ω	LED Sensitivity Adjustment	V _L (ON) is large	V _L (ON) is small	—
C ₅	1 μ F	LPF at LED	THD is bad at 50~300Hz	Slow LED response	—

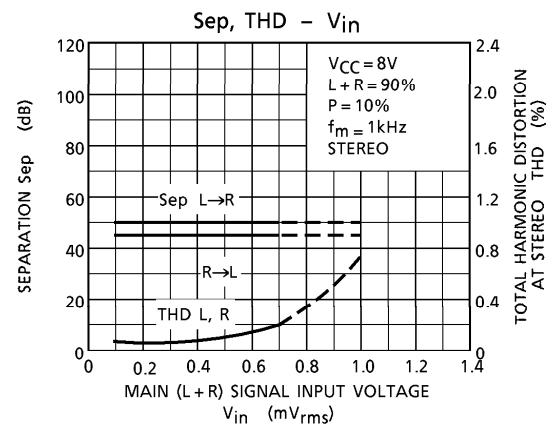
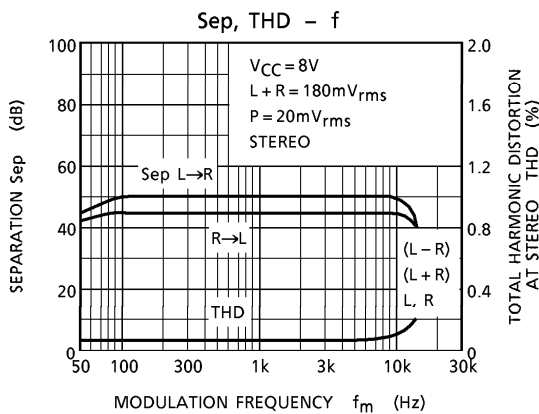
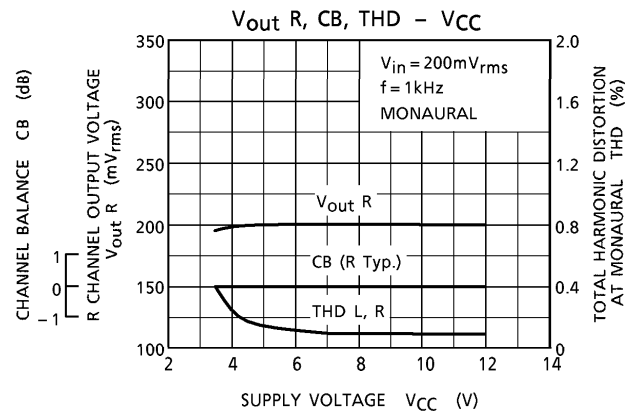
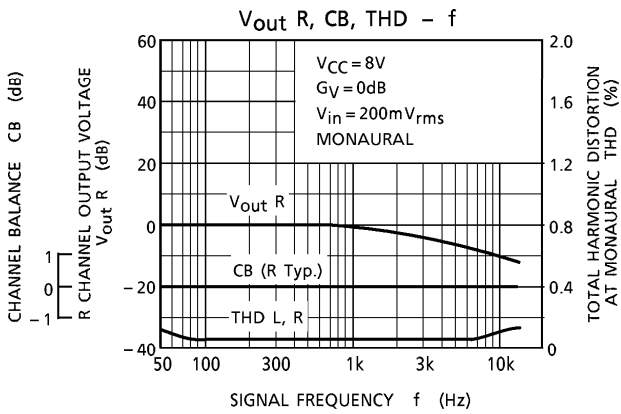
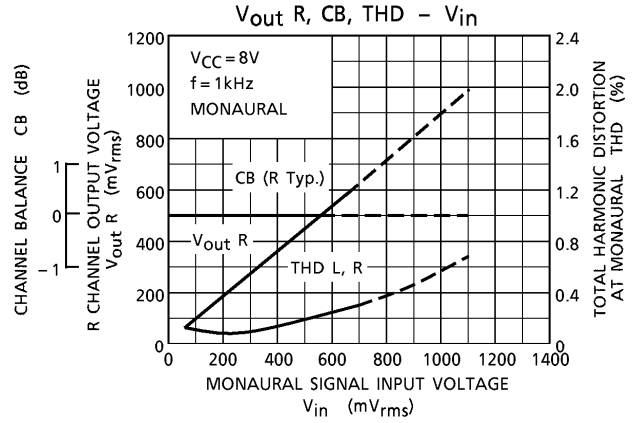
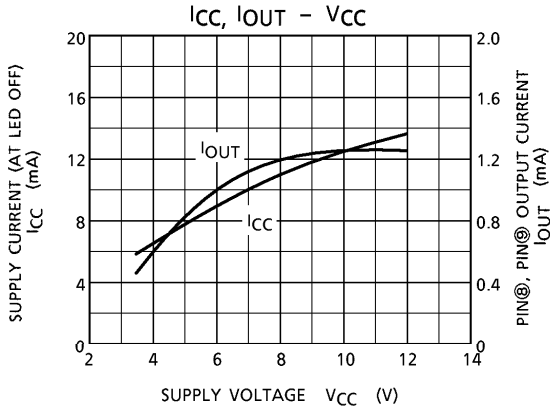

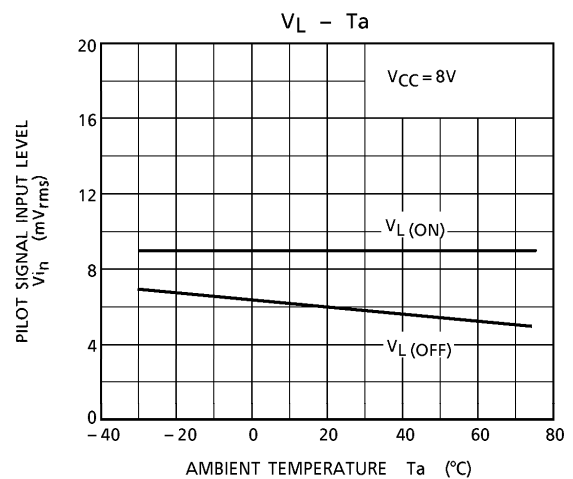
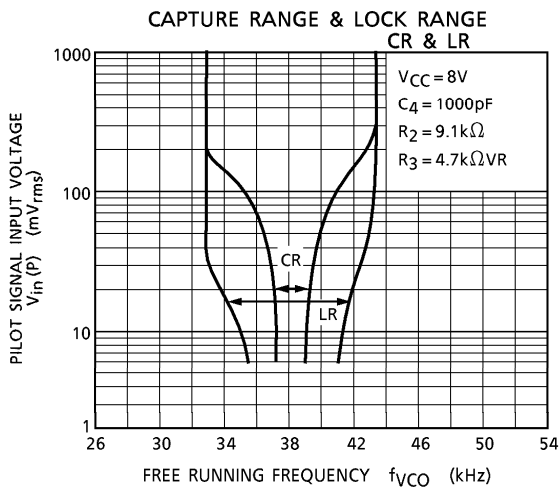
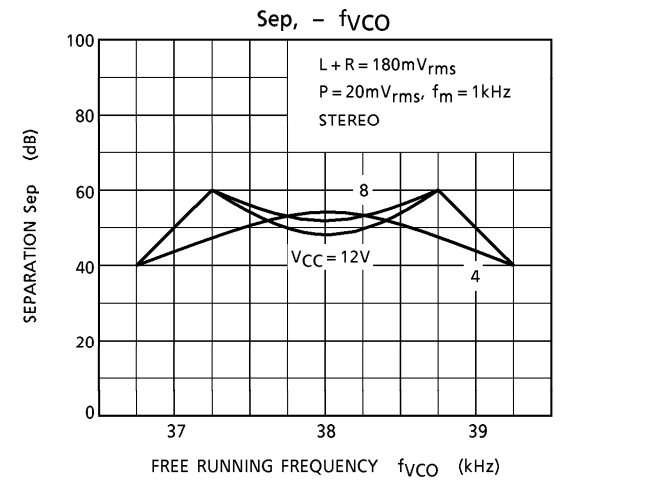
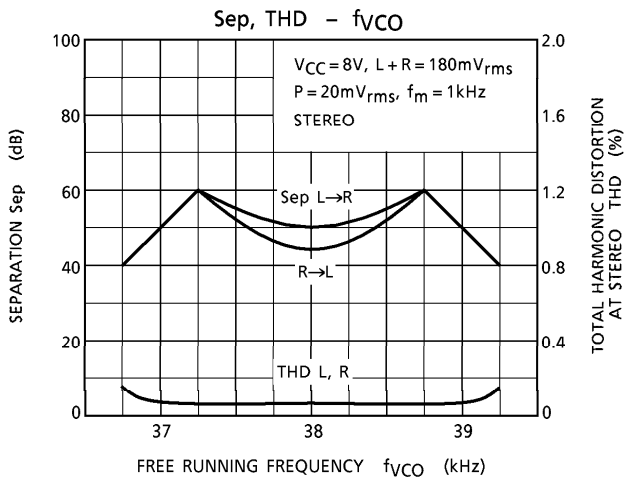
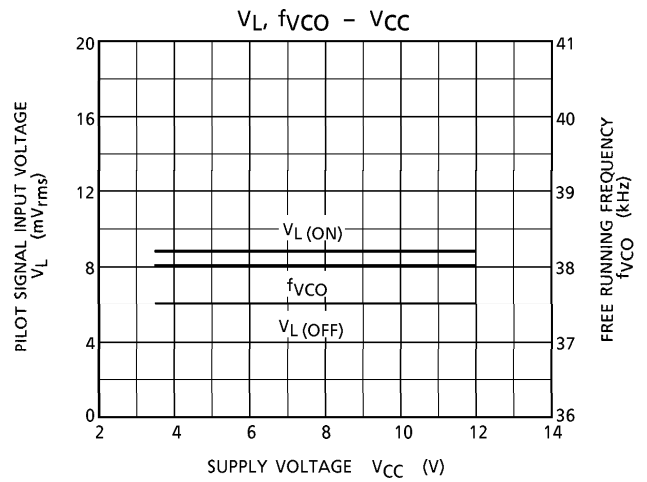
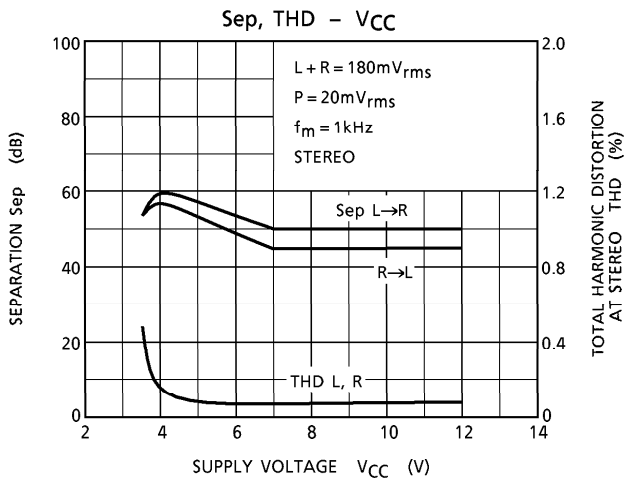

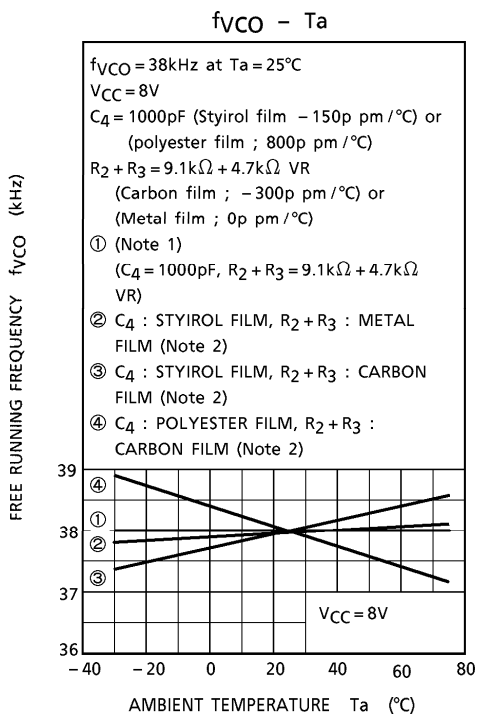
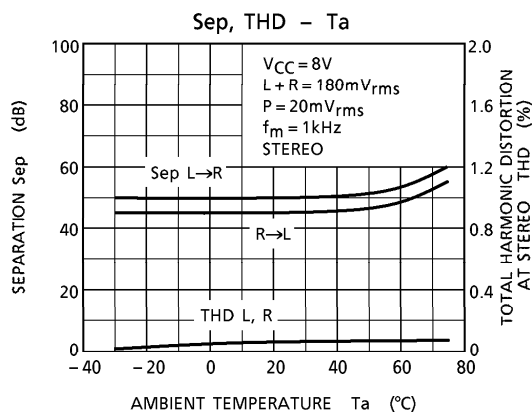
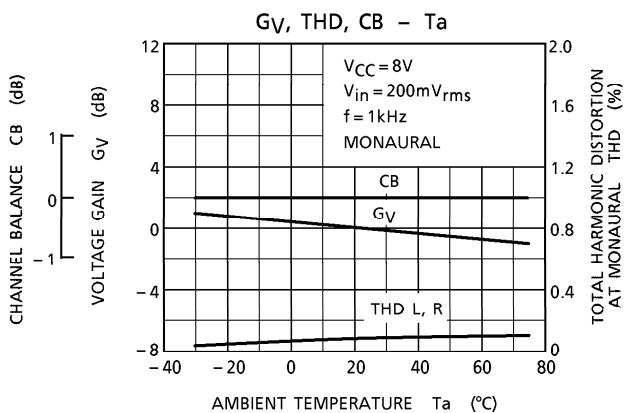

(Note 1) ① : With IC only put into a temperature test chamber

(Note 2) ②③④ : With IC, resistors and capacitors put into a temperature test chamber

OUTLINE DRAWING
SIP9-P-2.54A

Unit : mm

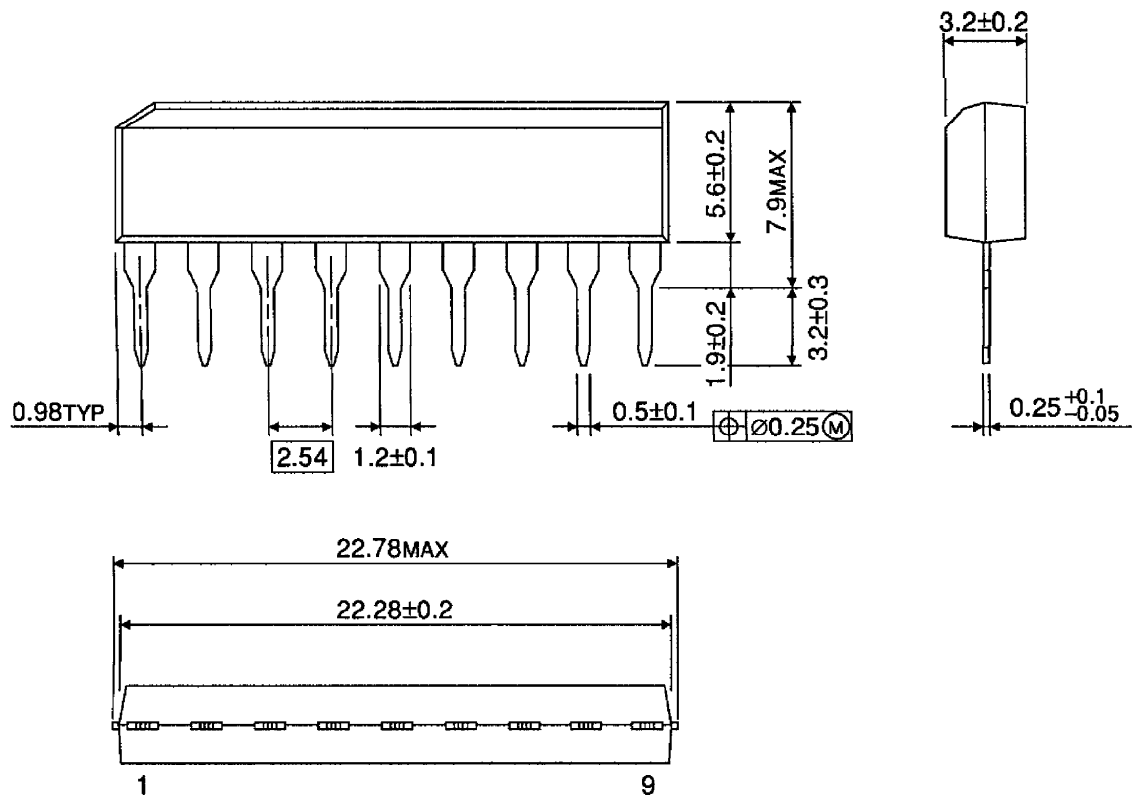

Weight : 0.92g (Typ.)