

PROGRAMMABLE TOUCH SCREEN CONTROLLER WITH AUDIO CODEC

FEATURES

- **SPI™ Serial Interface**
- **Touch screen Controller**
 - **4-Wire Touch Screen Interface**
 - **Internal Detection of Screen Touch and Keypad Press**
 - **Touch Pressure Measurement**
 - **Ratiometric Conversion**
 - **Programmable 8, 10 or 12 Bit Resolution**
 - **Programmable Sampling Rates Up to 125 kHz**
 - **Direct Battery Measurement (0 to 6 V)**
 - **On-Chip Temperature Measurement**
 - **4-by-4 Keypad Interface With Programmable De-bounce**
 - **Integrated Touch Screen Processor Reduces Host CPU Interrupts and Overhead**
 - **Internal Timing Control With Programmable Delays**
- **Audio Codec**
 - **20-Bit Delta-Sigma ADC/DAC**
 - **Dynamic Range: 98 dB**
 - **Sampling Rate Up To 48 kHz**
 - **I²S Serial Interface**
- **Full Power Down Control**
- **On-Chip Crystal Oscillator**
- **6 GPIO Pins**
- **Single 2.7-V to 3.6-V Supply**
- **64-pin TQFP Package**

APPLICATIONS

- **Personal Digital Assistants**
- **Cellular Phones**
- **MP3 Players**
- **Internet Appliances**
- **Smartphones**

DESCRIPTION

The TSC2300 is a highly integrated PDA analog interface circuit. It contains a complete 12-bit A/D resistive touch screen converter including drivers, touch pressure measurement capability, keypad controller and 8-bit D/A converter output for LCD contrast control. The TSC2300 offers programmable resolution of 8, 10, and 12 bits and sampling rates up to 125 kHz to accommodate different screen sizes. The TSC2300 interfaces to the host controller through a standard SPI serial interface.

The TSC2300 features a high-performance 20-bit, 48-kSPS audio codec with highly integrated analog functionality. The audio portion of the TSC2300 contains microphone input with built-in pre-amp and microphone bias circuit, an auxiliary stereo analog input, a stereo line-level output, a differential mono line-level output, and a stereo headphone amplifier output. The digital audio data is transferred through a standard I²S interface.

The TSC2300 also offers two battery measurement inputs capable of battery voltages up to 6 V, while operating at a supply voltage of only 2.7 V. It also has an on-chip temperature sensor capable of reading 0.3°C resolution. The TSC2300 is available in a 64-lead TQFP.

US Patent No. 6246394

SPI is a trademark of Motorola.



Please be aware that an important notice concerning availability, standard warranty, and use in critical applications of Texas Instruments semiconductor products and disclaimers thereto appears at the end of this data sheet.

TSC2300

SLAS372 — NOVEMBER 2002

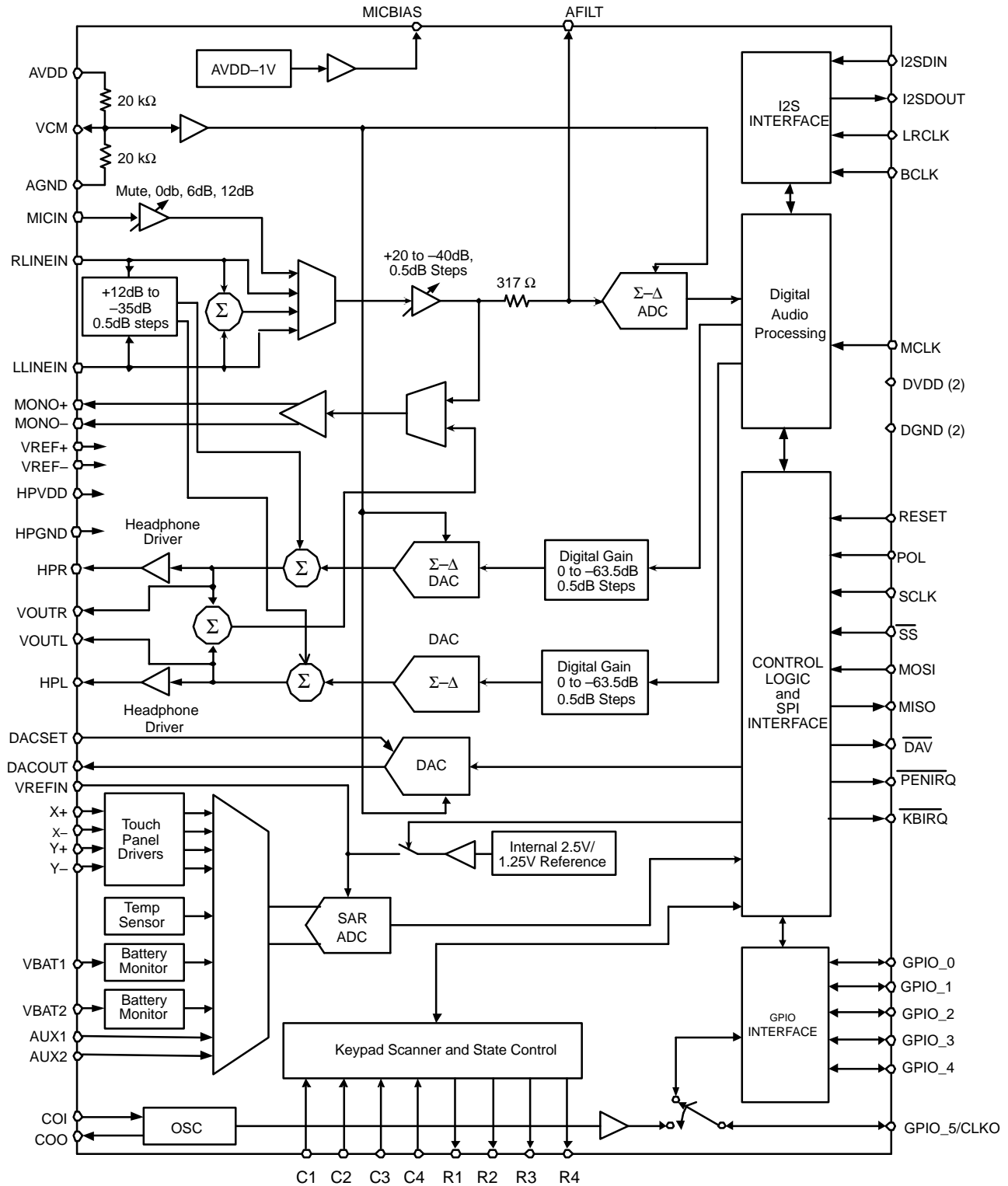

PACKAGE/ORDERING INFORMATION

PRODUCT	PACKAGE	PACKAGE DESIGNATOR	SPECIFICATION TEMPERATURE RANGE	ORDERING NUMBER	TRANSPORT MEDIA
TSC2300I	TQFP-64	PAG	-40°C to +85°C	TSC2300IPAG	Trays
				TSC2300IPAGR	Tape and Reel

ABSOLUTE MAXIMUM RATINGS

over operating free-air temperature range unless otherwise noted (1)

		TSC2300
Supply voltage:	AVDD, HPVDD, DVDD	4 V
Ground voltage differences:	AGND, DGND	±0.1 V
Digital input voltage		-0.3 V to (DV _{DD} + 0.3 V)
Analog input voltage		-0.3 V to (AV _{DD} + 0.3 V)
Ambient temperature under bias, T _A		-40°C to 125°C
Storage temperature, T _{stg}		-55°C to 150°C
Junction temperature, T _J		150°C
Lead temperature 1,6 mm (1/16 inch) from case for 10 seconds		260°C

- (1) Stresses beyond those listed under "absolute maximum ratings" may cause permanent damage to the device. These are stress ratings only, and functional operation of the device at these or any other conditions beyond those indicated under "recommended operating conditions" is not implied. Exposure to absolute-maximum-rated conditions for extended periods may affect device reliability.

TSC2300

SLAS372 — NOVEMBER 2002

ELECTRICAL CHARACTERISTICS

 At 25°C, $HPV_{DD} = AV_{DD} = DV_{DD} = +3.3\text{ V}$, $V_{REF} = \text{External } 2.5\text{ V}$, unless otherwise noted.

PARAMETER	CONDITIONS	TSC2300			UNITS
		MIN	TYP	MAX	
AUXILIARY ANALOG INPUTS					
Input voltage range		0		+VREFIN	V
Input capacitance			25		pF
Input leakage current			1		μA
BATTERY MONITOR INPUT					
Input voltage range		0.5		6.0	V
Input capacitance			25		pF
Input leakage current			±1		μA
TEMPERATURE MEASUREMENT					
Temperature range		-40		+85	°C
Temperature resolution			0.3		°C
Accuracy			±2		°C
TOUCH SCREEN A/D CONVERTER					
Resolution	Programmable: 8-, 10-, 12-Bits			12	Bits
No missing codes	12-bit resolution		10		Bits
Integral linearity				±6	LSB
Offset error				±6	LSB
Gain error				±6	LSB
Noise			<300		μV RMS
AUDIO CODEC					
Sampling frequency				48	kHz
AUDIO I/O					
Audio in	Line, Mic inputs	0.15* AVDD		0.65* AVDD	V
Audio out	Line outputs	0.15* AVDD		0.65* AVDD	V
AUDIO ADC					
	ADC performance measured using Fs=48 KHz				
Signal-to-noise ratio, A-weighted	1 kHz input	80	88		dB
Total harmonic distortion	1 kHz, -0.5 dB input		-70	-60	dB
Full-scale input voltage			0.18* AVDD		Vrms
Transition band		0.45Fs		0.55Fs	Hz
Stop band		0.55Fs		127Fs	Hz
Stop band rejection			70dB		
AUDIO DAC					
	DAC performance measured at Line Outputs using Fs=48 KHz				
Full-scale output voltage			0.18* AVDD		Vrms
Signal-to-noise ratio, A-weighted	1 kHz input		98		dB
Total harmonic distortion	1 kHz, 0 dB input		-100		dB
Frequency response		20		0.45Fs	Hz
Transition band		0.45Fs		0.55Fs	Hz
Stop band		0.55Fs		3.5Fs	Hz
Stop band rejection			65		dB

ELECTRICAL CHARACTERISTICS (continued)

 At 25°C, $HPV_{DD} = AV_{DD} = DV_{DD} = +3.3\text{ V}$, $V_{REF} = \text{External } 2.5\text{ V}$, unless otherwise noted.

PARAMETER	CONDITIONS	TSC2300			UNITS
		MIN	TYP	MAX	
HEADPHONE DRIVER					
	DAC playback through headphone driver				
Output power per channel	R=32 Ω		14		mW
	R=16 Ω		27		mW
	R=16 Ω V_{DD} =3.6V		32		mW
Signal-to-noise ratio, A-weighted		85	96		dB
Total harmonic distortion	R=32 Ω 1 kHz, 0 dB input		-83	-70	dB
	R=16 Ω 1 kHz, -3 dB input		-77		dB
D/A CONVERTER					
Output current range	Measured with ARNG floating	0.75	1.10		mA
Resolution				8.8	Bits
VOLTAGE REFERENCE					
Voltage range	Internal 2.5 V	2.34	2.49	2.54	V
Reference drift			50		ppm/ $^{\circ}$ C
Current drain			20		μ A
DIGITAL INPUT / OUTPUT					
Internal clock frequency			8.8		MHz
Logic family			CMOS		
Logic level: V_{IH}	I_{IH} =5 μ A	0.7 V_{DD}			V
V_{IL}	I_{IL} =5 μ A	-0.3		0.3 V_{DD}	V
V_{OH}	I_{OH} =2 TTL loads	0.8* DVDD			V
V_{OL}	I_{OL} =2 TTL loads			0.2* DVDD	V
POWER SUPPLY REQUIREMENTS					
Power supply voltage					
DV_{DD} , AV_{DD} , HPV_{DD}		2.7		3.6	V
Quiescent current (1)					
Touch screen only	1 kHz SAR sample rate, external V_{ref}		14		μ A
Touch screen only	20 kHz SAR sample rate, internal V_{ref}		1.7		mA
Playback only	44.1 kHz Playback, V_{DD} =2.7V		10		mA
Voice Record only	Mono 8 kHz record, V_{DD} =2.7V		5.8		mA
Power down	Audio fully powered down		.05		μ A

(1) For more details on power consumption, see the Audio Codec section of the description overview.

PIN ASSIGNMENT
(TOP VIEW)

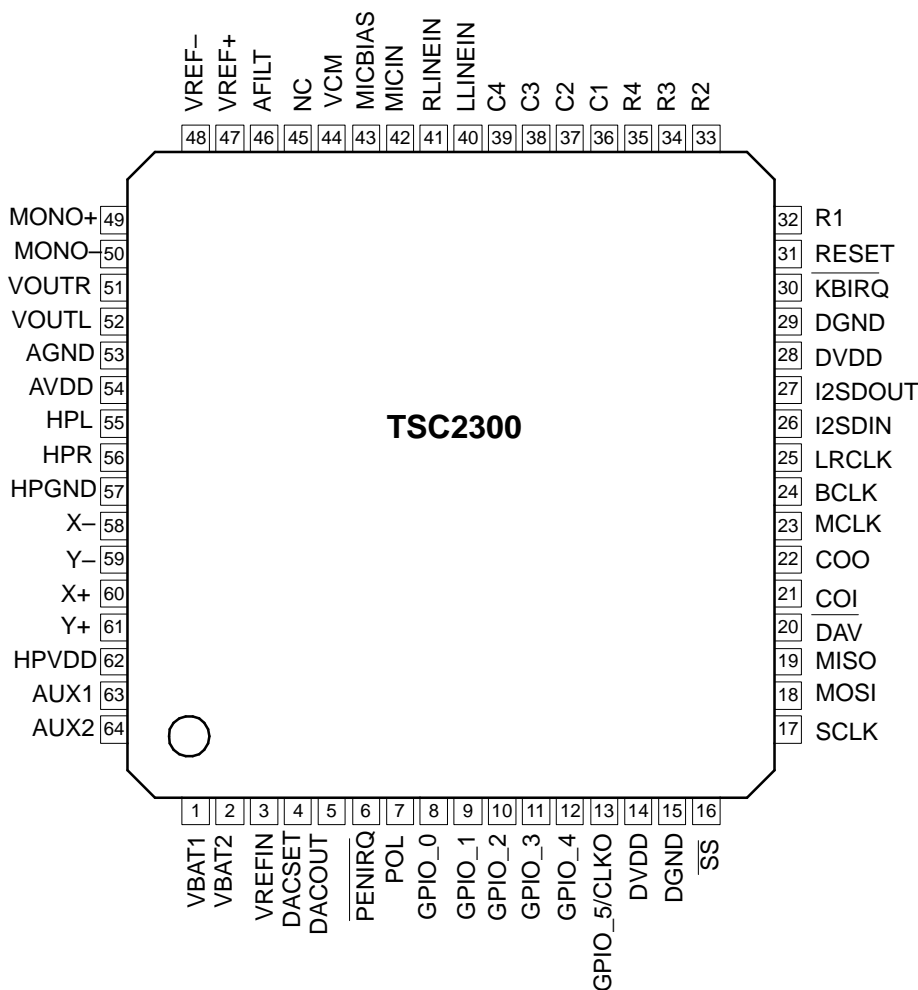

PIN DESCRIPTION

PIN	I/O	NAME	DESCRIPTION
1	I	VBAT1	Battery monitor input 1
2	I	VBAT2	Battery monitor input 2
3	I/O	VREFIN	SAR reference voltage
4		ARNG	DAC analog output range set
5	O	AOUT	Analog output current from DAC
6	O	$\overline{\text{PENIRQ}}$	Pen interrupt
7	I	POL	SPI clock polarity
8	I/O	GPIO_0	General-purpose input/output pin
9	I/O	GPIO_1	General-purpose input/output pin
10	I/O	GPIO_2	General-purpose input/output pin
11	I/O	GPIO_3	General-purpose input/output pin
12	I/O	GPIO_4	General-purpose input/output pin
13	I/O	GPIO_5/CLKO	General-purpose input/output pin/buffered oscillator clock out
14	I	DVDD	Digital voltage supply

PIN DESCRIPTION (continued)

PIN	I/O	NAME	DESCRIPTION
15	I	DGND	Digital ground
16	I	\overline{SS}	Slave select input (active low). Data is not clocked into DIN unless \overline{SS} is low. When \overline{SS} is high, MOIS is high impedance.
17	I	SCLK	SPI clock input
18	I	MOSI	SPI data input. Data is clocked in at SCLK rising edge
19	O	MISO	SPI data output. Data is clocked out at SCLK falling edge. High impedance when \overline{SS} is high.
20	O	\overline{DAV}	Data available (active low).
21	I	COI	Crystal input
22	O	COO	Crystal output
23	I	MCLK	Master clock input for audio codec
24	I	BCLK	I ² S bit clock
25	I	LRCLK	I ² S left/right clock
26	I	I2SDIN	I ² S serial data in
27	O	I2SDOUT	I ² S serial data out
28	I	DVDD	Digital voltage supply
29	I	DGND	Digital ground
30	O	\overline{KBIRQ}	Keypad interrupt (active low). Indicates a key has been depressed
31	I	RESET	Device reset (active high)
32	O	R1	Keypad row 1
33	O	R2	Keypad row 2
34	O	R3	Keypad row 3
35	O	R4	Keypad row 4
36	I	C1	Keypad column 1
37	I	C2	Keypad column 2
38	I	C3	Keypad column 3
39	I	C4	Keypad column 4
40	I	LLINEIN	Left-channel analog input to audio codec
41	I	RLINEIN	Right-channel analog input to audio codec
42	I	MICIN	Analog input from microphone
43	O	MICBIAS	Bias voltage output
44	O	VCM	Common-mode voltage bypass capacitor
45	O	NC	No connection
46	O	AFILT	Audio ADC antialiasing filter capacitor
47	I	VREF+	Audio codec positive reference voltage
48	I	VREF-	Audio codec negative reference voltage
49	O	MONO+	Mono differential output
50	O	MONO-	Mono differential output
51	O	VOUTR	Audio right line output
52	O	VOUTL	Audio left line output
53	I	AGND	Analog ground
54	I	AVDD	Analog supply
55	O	HPL	Headphone amplifier left output
56	O	HPR	Headphone amplifier right output
57	I	HPGND	Analog ground for headphone amplifier and touch screen circuitry
58	I	X-	X- position input
59	I	Y-	Y- position input

TSC2300

SLAS372 — NOVEMBER 2002

PIN DESCRIPTION (continued)

PIN	I/O	NAME	DESCRIPTION
60	I	X+	X+ position input
61	I	Y+	Y+ position input
62	I	HPVDD	Analog supply for headphone amplifier and touch screen circuitry
63	I	AUX1	SAR auxiliary analog input 1
64	I	AUX2	SAR auxiliary analog input 2

TIMING DIAGRAM

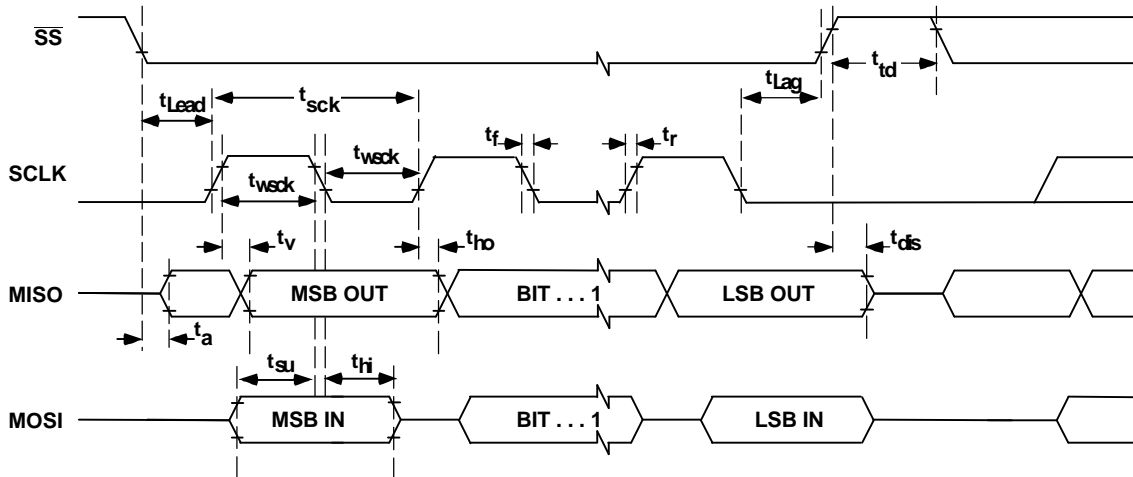

TIMING CHARACTERISTICS (1) (2)

All specifications typical at -40°C to +85°C, +V_{DD} = +2.7 V.

PARAMETER	SYMBOL	MIN	MAX	UNITS
SCLK period	t _{sck}	30		ns
Enable lead time	t _{Lead}	15		ns
Enable lag time	t _{Lag}	15		ns
Sequential transfer delay	t _{td}	30		ns
Data setup time	t _{su}	10		ns
Data hold time (inputs)	t _{hi}	10		ns
Data hold time (outputs)	t _{ho}	0		ns
Slave access time	t _a		15	ns
Slave DOUT disable time	t _{dis}		15	ns
Data valid	t _v		10	ns
Rise time	t _r		30	ns
Fall time	t _f		30	ns

- (1) All input signals are specified with t_R = t_F = 5ns (10% to 90% of V_{DD}) and timed from a voltage level of (V_{IL} + V_{IH})/2.
 (2) See timing diagram, above.

TYPICAL CHARACTERISTICS

At $T_A = +25^\circ\text{C}$, $+V_{DD} = +3.3\text{ V}$, $V_{REF} = +2.5\text{ V}$, $f_{SAMPLE} = 125\text{ kHz}$, unless otherwise noted.

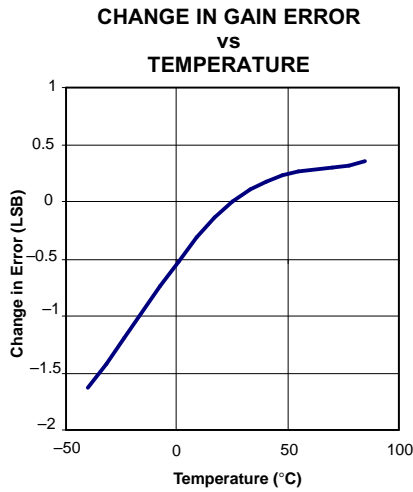

Figure 1

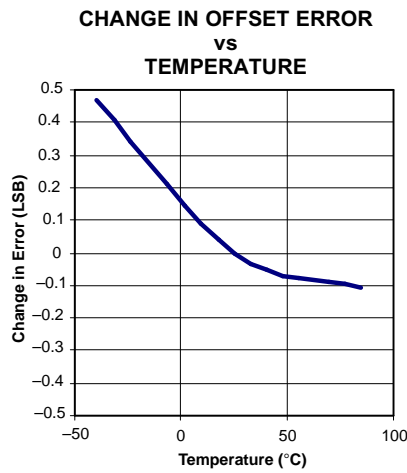

Figure 2

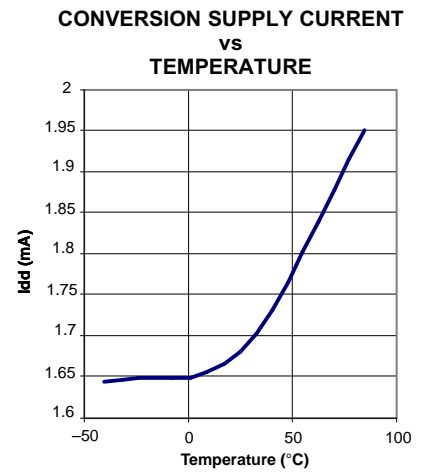

Figure 3

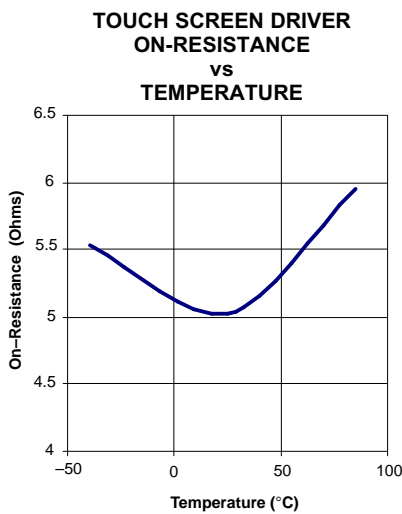

Figure 4

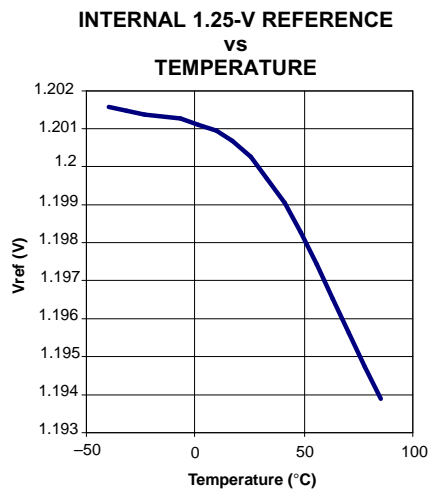

Figure 5

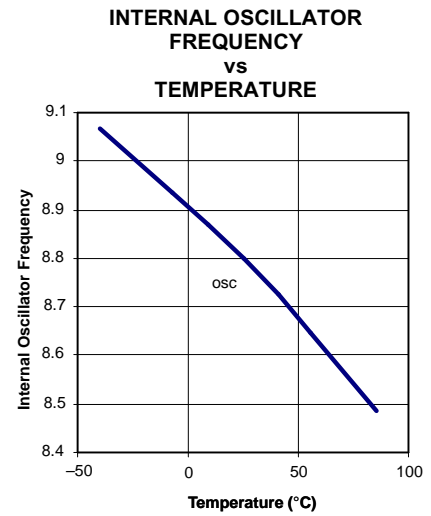

Figure 6

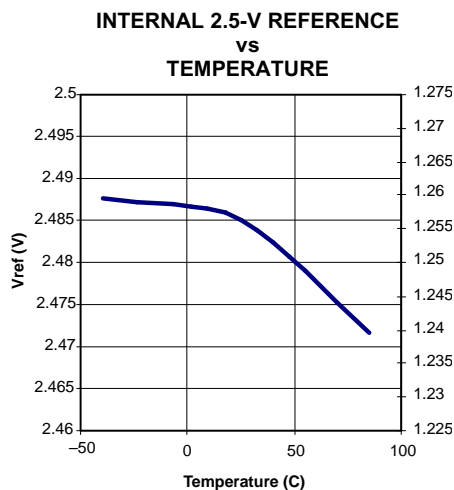

Figure 7

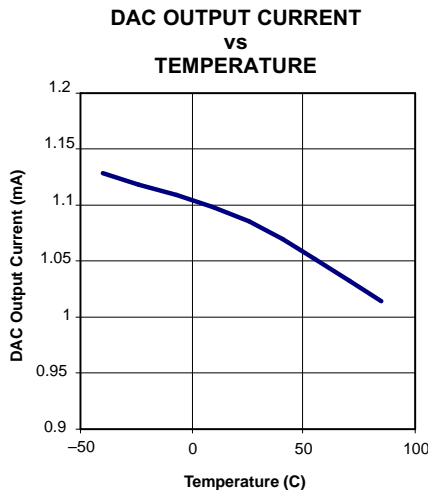

Figure 8

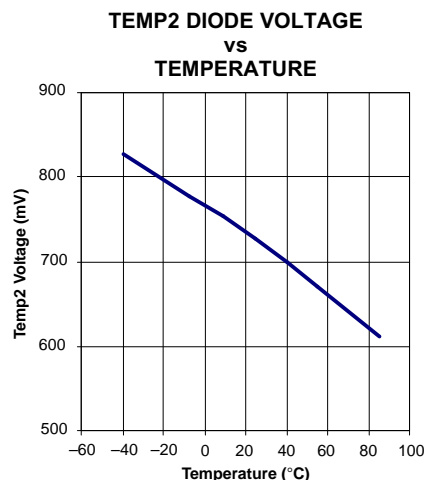

Figure 9

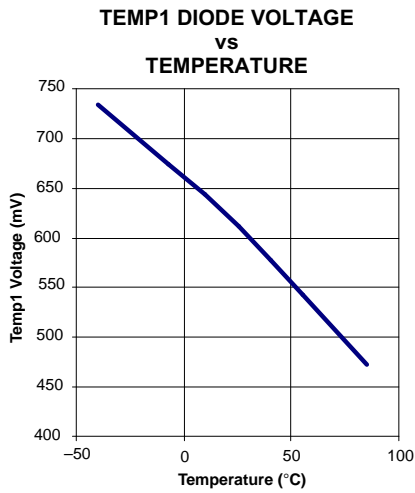

Figure 10

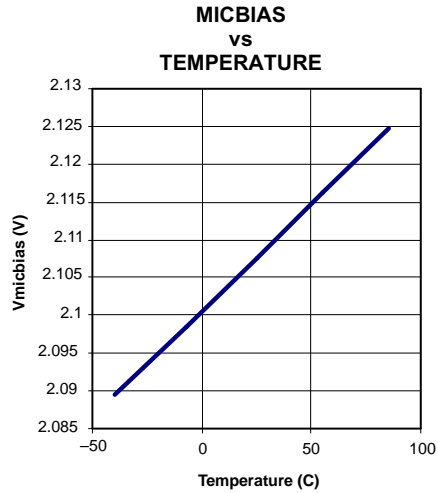

Figure 11

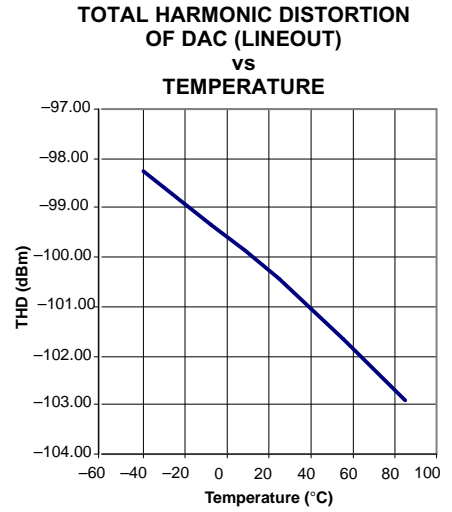

Figure 12

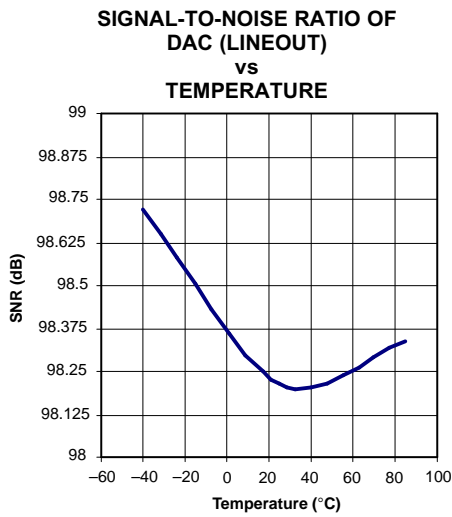

Figure 13

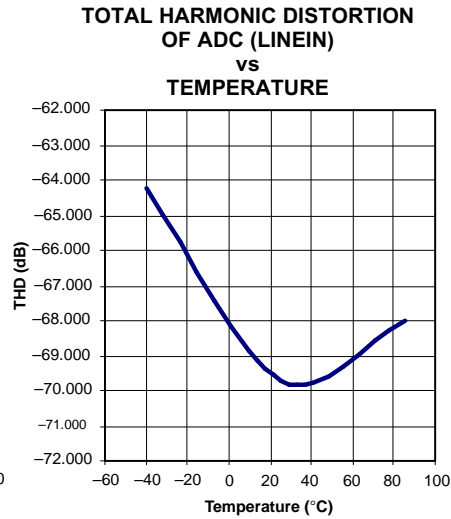

Figure 14

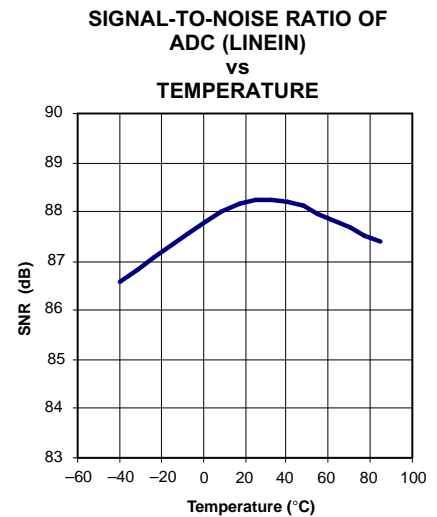

Figure 15

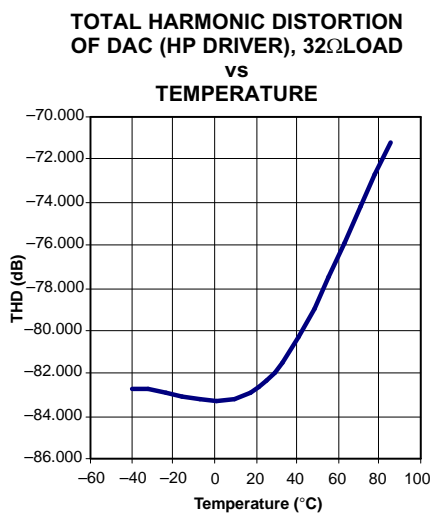

Figure 16

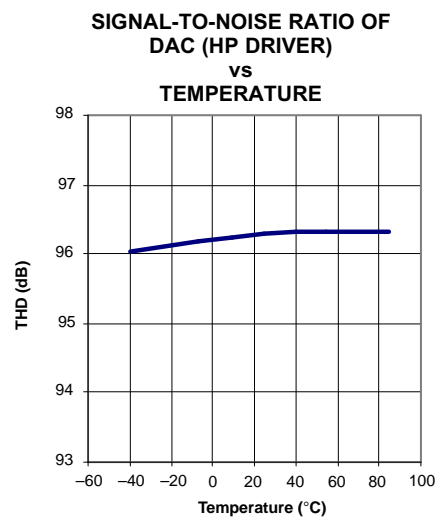

Figure 17

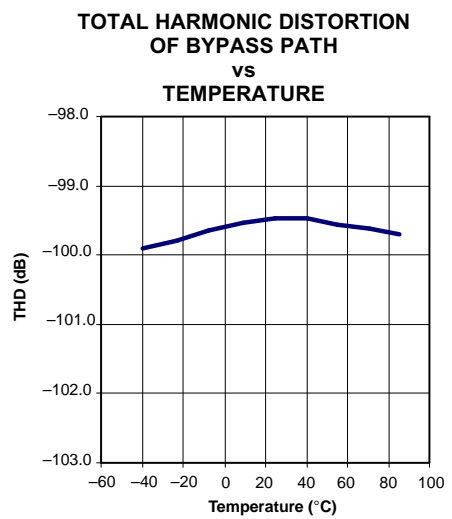

Figure 18

TSC2300

SLAS372 — NOVEMBER 2002

SIGNAL-TO-NOISE RATIO OF BYPASS PATH vs TEMPERATURE

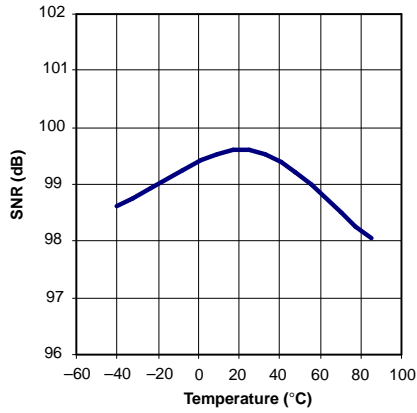

Figure 19

TOTAL HARMONIC DISTORTION OF MONO PATH vs TEMPERATURE

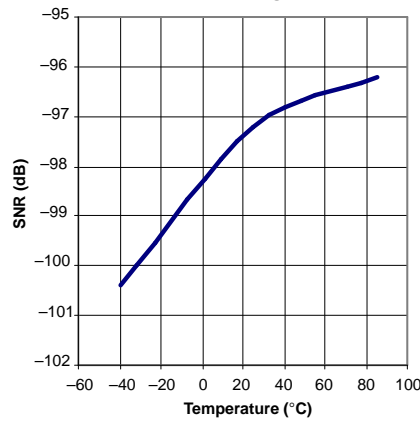

Figure 20

SIGNAL-TO-NOISE RATIO OF MONO PATH vs TEMPERATURE

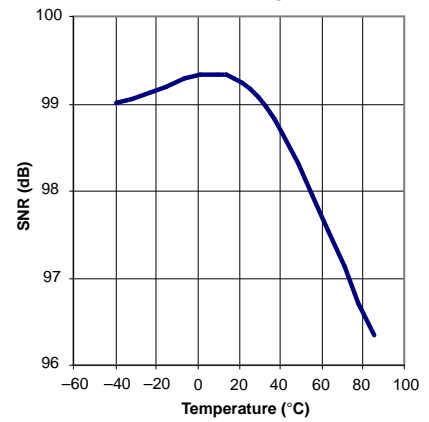

Figure 21

1.25-V REFERENCE vs SUPPLY VOLTAGE

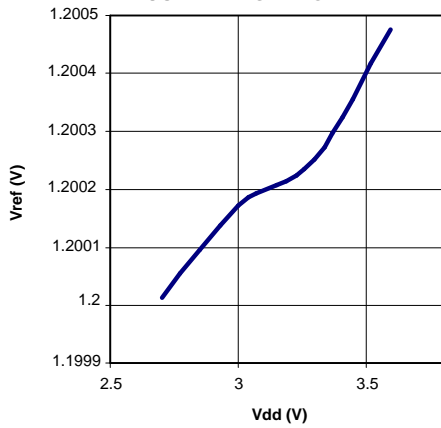

Figure 22

2.5-V INTERNAL REFERENCE vs SUPPLY VOLTAGE

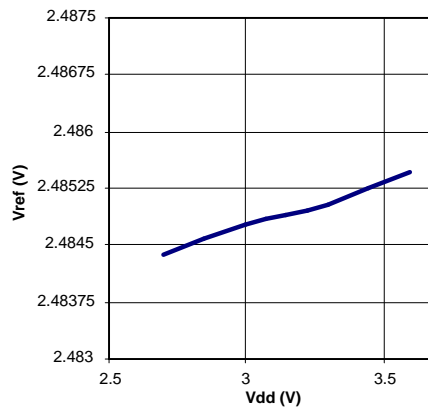

Figure 23

SWITCH ON-RESISTANCE vs SUPPLY VOLTAGE

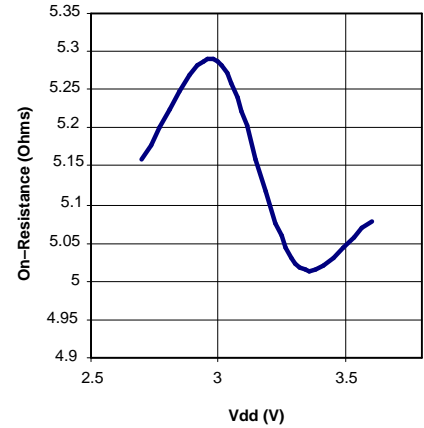

Figure 24

TEMP2 DIODE VOLTAGE vs SUPPLY VOLTAGE

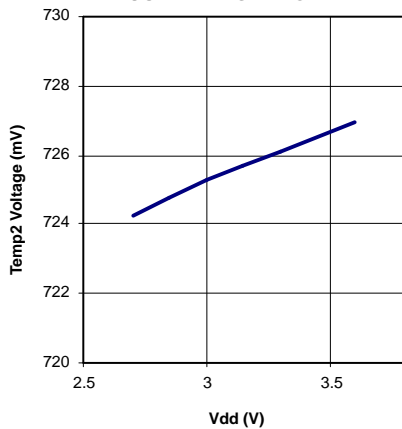

Figure 25

TEMP1 DIODE VOLTAGE vs SUPPLY VOLTAGE

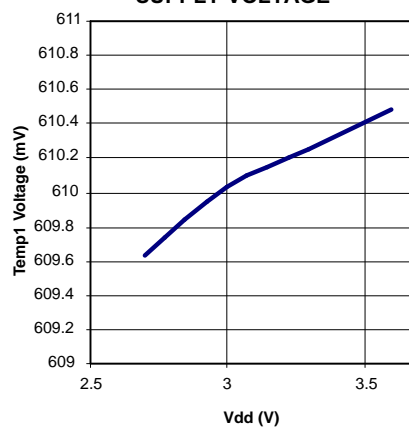

Figure 26

INTERNAL OSCILLATOR FREQUENCY vs SUPPLY VOLTAGE

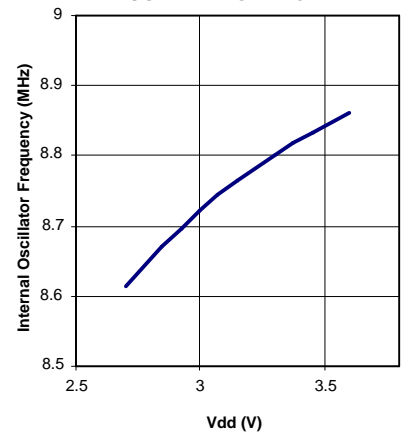

Figure 27

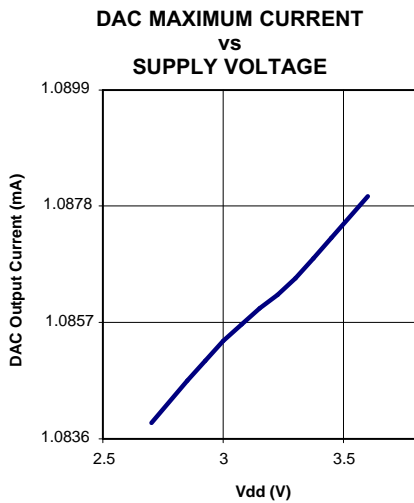

Figure 28

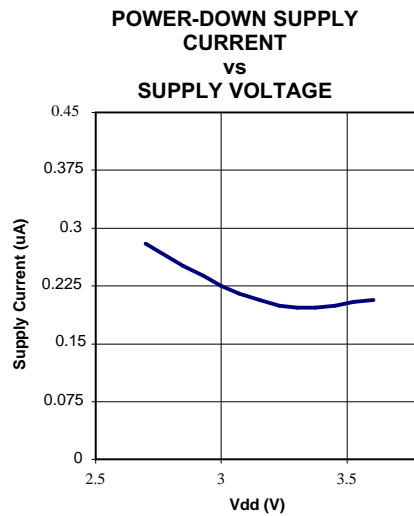

Figure 29

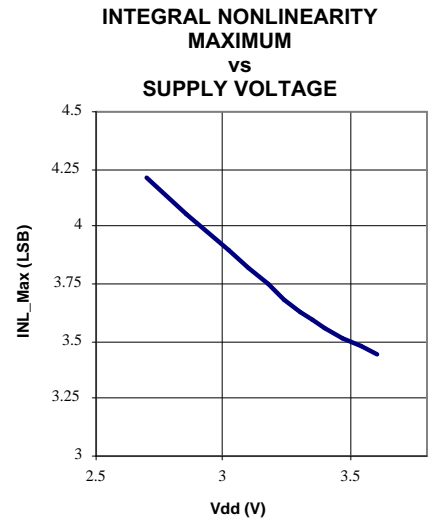

Figure 30

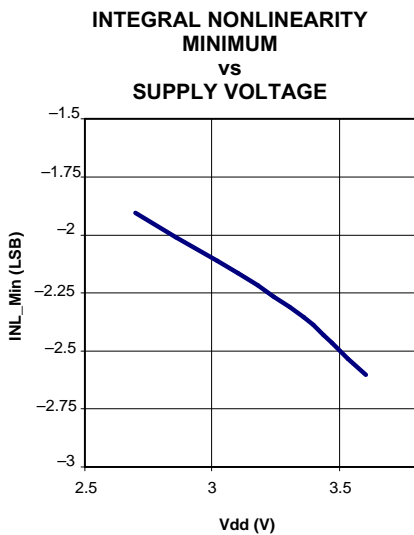

Figure 31

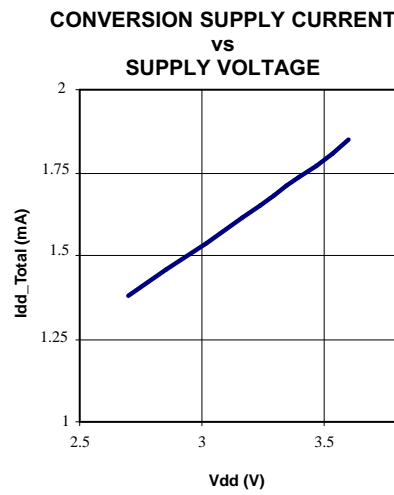

Figure 32

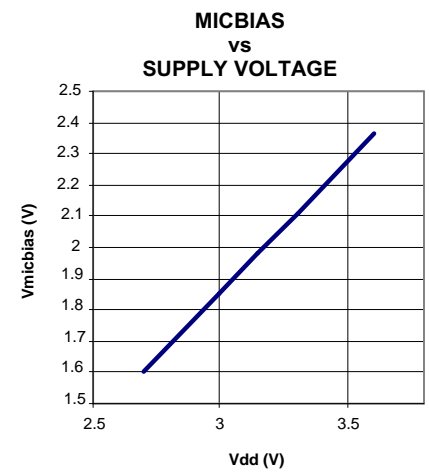

Figure 33

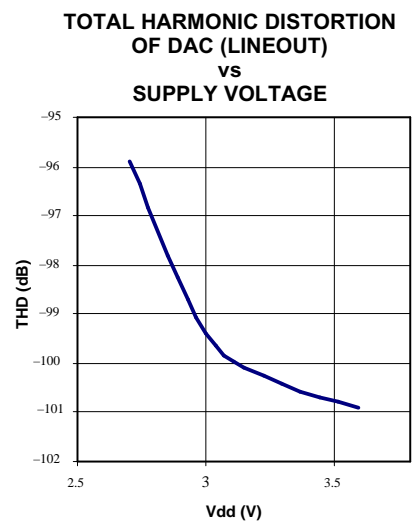

Figure 34

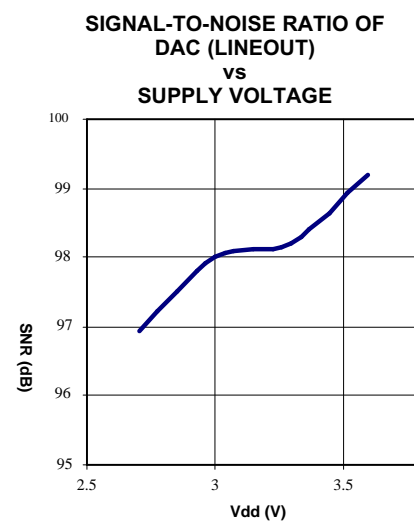

Figure 35

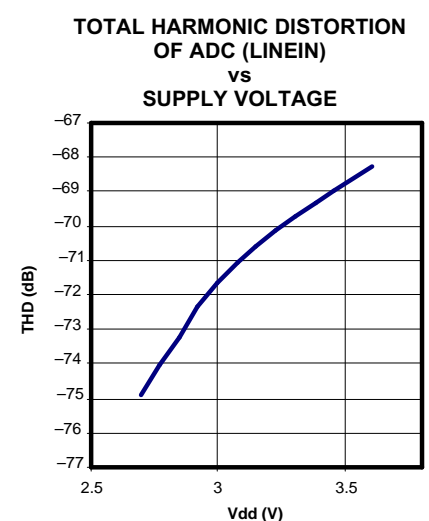

Figure 36

**SIGNAL-TO-NOISE RATIO OF
ADC (LINEIN)
vs
SUPPLY VOLTAGE**

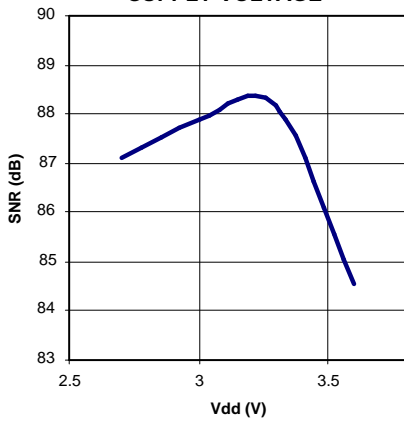

Figure 37

**TOTAL HARMONIC DISTORTION
OF DAC (HP DRIVER)
vs
SUPPLY VOLTAGE**

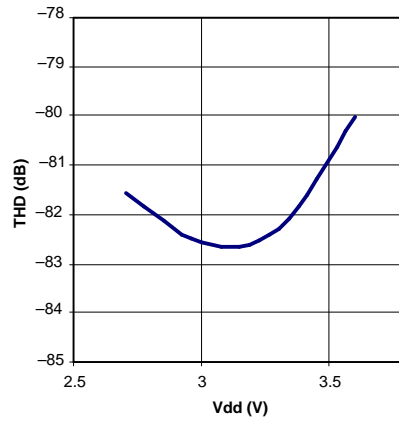

Figure 38

**SIGNAL-TO-NOISE RATIO OF
DAC (HP DRIVER)
vs
SUPPLY VOLTAGE**

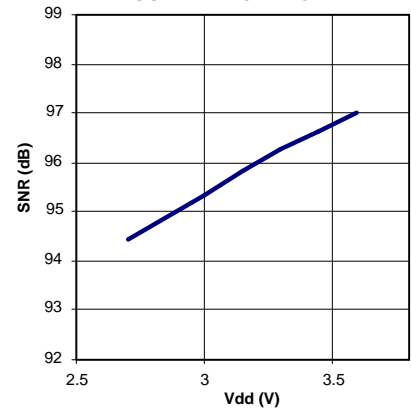

Figure 39

**TOTAL HARMONIC DISTORTION
OF BYPASS PATH
vs
SUPPLY VOLTAGE**

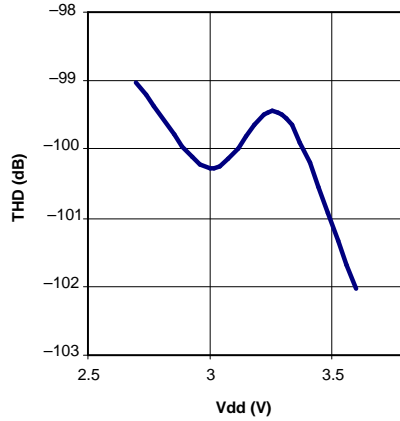

Figure 40

**SIGNAL-TO-NOISE RATIO OF
BYPASS PATH
vs
SUPPLY VOLTAGE**

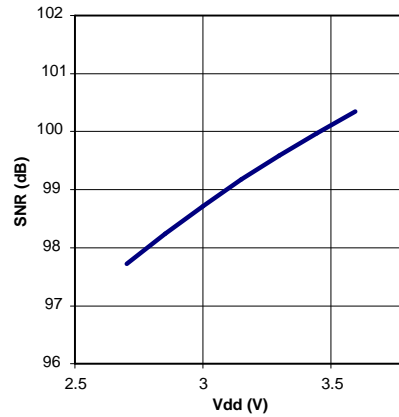

Figure 41

**TOTAL HARMONIC DISTORTION
OF MONO PATH
vs
SUPPLY VOLTAGE**

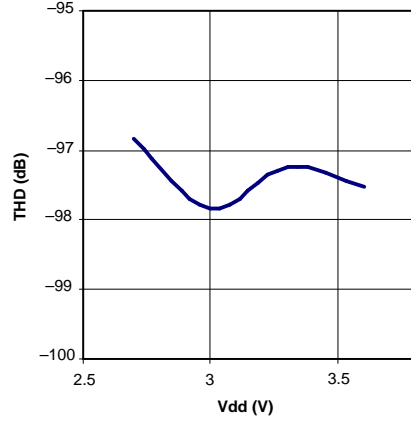

Figure 42

**SIGNAL-TO-NOISE RATIO OF
MONO PATH
vs
SUPPLY VOLTAGE**

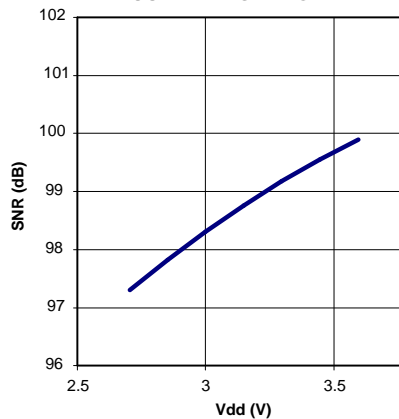

Figure 43

OVERVIEW

The TSC2300 is an analog interface circuit for human interface devices. A register-based architecture eases integration with microprocessor-based systems through a standard SPI bus. All peripheral functions are controlled through the registers and onboard state machines.

The TSC2300 consists of the following blocks (refer to the block diagram on p. 2):

- Touch Screen Interface
- Keypad Interface
- Battery Monitors
- Auxiliary Inputs
- Temperature Monitor
- Current Output Digital-to-Analog Converter
- Audio Codec and Signal Processing

Communication to the TSC2300 is via a standard SPI serial interface. This interface requires that the slave select signal be driven low to communicate with the TSC2300. Data is then shifted into or out of the TSC2300 under control of the host microprocessor, which also provides the serial data clock.

Control of the TSC2300 and its functions is accomplished by writing to different registers in the TSC2300. A simple command protocol is used to address the 16-bit registers. Registers control the operation of the touch screen A/D converter, keypad scanner, and audio codec.

The result of measurements made will be placed in the TSC2300's memory map and may be read by the host at any time. Three signals are available from the TSC2300 to indicate that data is available for the host to read. The $\overline{\text{DAV}}$ output indicates that an analog-to-digital conversion has completed and that data is available. The $\overline{\text{KBIRQ}}$ output indicates that an unmasked key on the keypad has been pressed and de-bounced. The $\overline{\text{PENIRQ}}$ output indicates that a touch has been detected on the touch screen.

A typical application of the TSC2300 is shown in Figure 44.

TSC2300

SLAS372 — NOVEMBER 2002

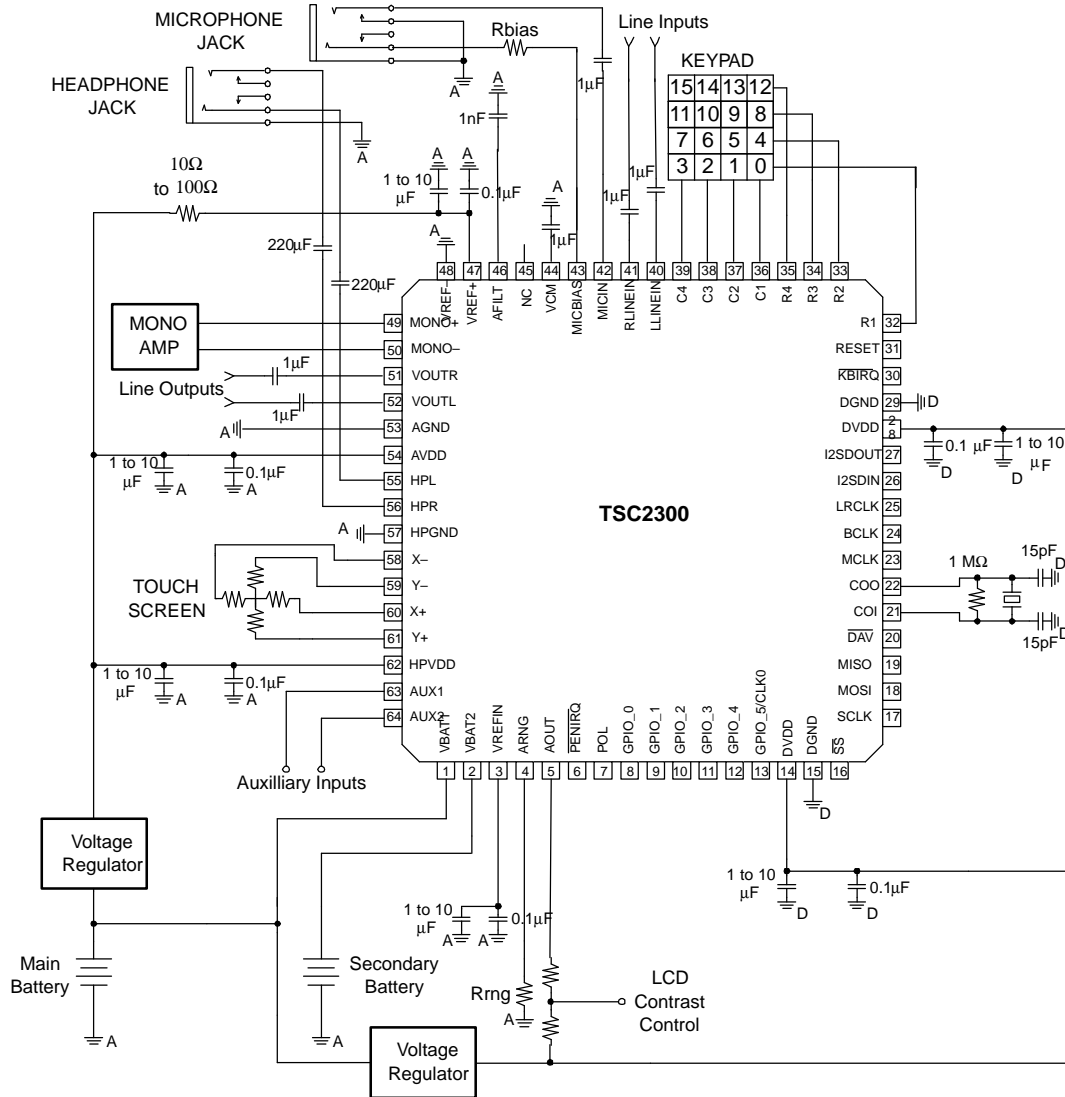

Figure 44. Typical Circuit Configuration.

DETAILED DESCRIPTION

OPERATION - TOUCH SCREEN

A resistive touch screen works by applying a voltage across a resistor network and measuring the change in resistance at a given point on the matrix where a screen is touched by an input stylus, pen, or finger. The change in the resistance ratio marks the location on the touch screen.

The TSC2300 supports the resistive 4-wire configuration (see Figure 44). The circuit determines location in two coordinate pair dimensions, although a third dimension can be added for measuring pressure.

The 4-Wire Touch Screen Coordinate Pair Measurement

A 4-wire touch screen is constructed as shown in Figure 45. It consists of two transparent resistive layers separated by insulating spacers.

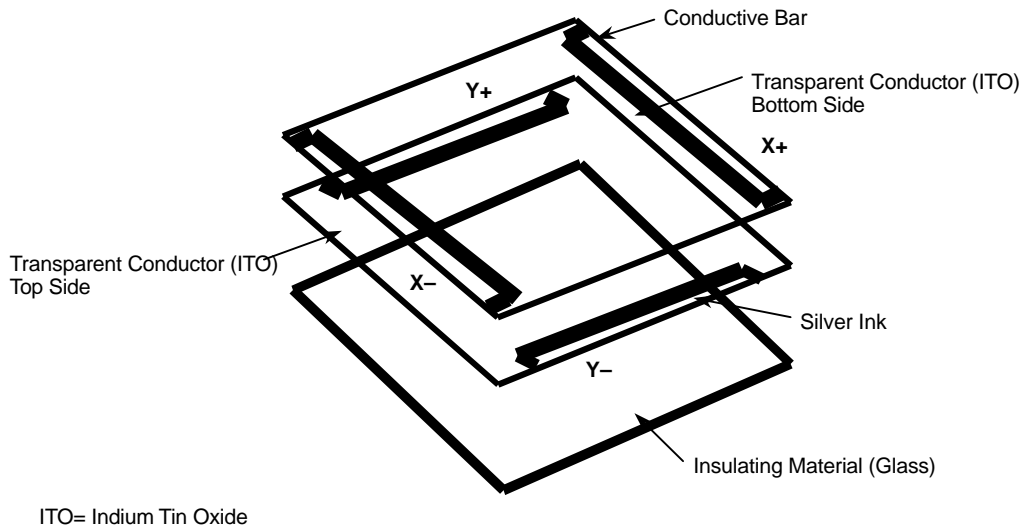

Figure 45. 4-wire Touch Screen Construction

The 4-wire touch screen panel works by applying a voltage across the vertical or horizontal resistive network. The A/D converts the voltage measured at the point where the panel is touched. A measurement of the Y position of the pointing device is made by connecting the X+ input to A/D converter input, driving Y+ to +VDD and Y- to GND using switches internal to the TSC2300, and digitizing the voltage seen at the X+ input. The voltage measured is determined by the voltage divider developed at the point of touch. For this measurement, the horizontal panel resistance in the X+ lead does not affect the conversion, due to the high input impedance of the A/D converter.

Voltage is then applied to the other axis, and the A/D converts the voltage representing the X position on the screen. This provides the X and Y coordinates to the associated processor.

Measuring touch pressure (Z) can also be done with the TSC2300. To determine pen or finger touch, the pressure of the touch needs to be determined. Generally, it is not necessary to have very high performance for this test, therefore, the 8-bit resolution mode is recommended (however, calculations are shown with the 12-bit resolution mode). There are several different ways of performing this measurement. The TSC2300 supports two methods. The first method requires knowing the X-plate resistance, measurement of the X-Position, and two additional cross panel measurements (Z2 and Z1) of the touch screen (see Figure 46). Using equation 1 calculates the touch resistance:

$$R_{\text{TOUCH}} = R_{\text{X-plate}} \frac{\text{X-position}}{4096} \left(\frac{Z_2}{Z_1} - 1 \right) \quad (1)$$

The second method requires knowing both the X-plate and Y-plate resistance, measurement of X-position and Y-position, and Z₁. Using equation 2 will also calculate the touch resistance:

$$R_{\text{TOUCH}} = \left(\frac{R_{\text{X-plate}} \text{X-position}}{4096} \right) \left(\frac{4096}{Z_1} - 1 \right) - R_{\text{Y-plate}} \left(1 - \frac{\text{Y-position}}{4096} \right) \quad (2)$$

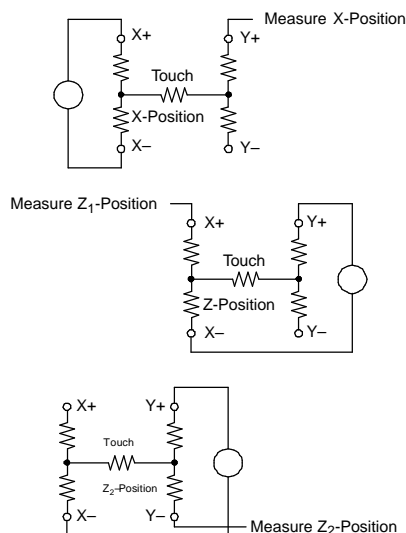

Figure 46. Pressure Measurement

When the touch panel is pressed or touched, and the drivers to the panel are turned on, the voltage across the touch panel often overshoots and then slowly settles (decay) down to a stable dc value. This is due to mechanical bouncing, which is caused by vibration of the top layer sheet of the touch panel when the panel is pressed. This settling time must be accounted for, or else the converted value is in error. Therefore, a delay must be introduced between the time the driver for a particular measurement is turned on, and the time measurement is made.

In some applications, external capacitors may be required across the touch screen for filtering noise picked up by the touch screen, i.e. noise generated by the LCD panel or back-light circuitry. The value of these capacitors provides a low-pass filter to reduce the noise, but causes an additional settling time requirement when the panel is touched.

Several solutions to this problem are available in the TSC2300. A programmable delay time is available which sets the delay between turning the drivers on and making a conversion. This is referred to as the panel voltage stabilization time, and is used in some of the modes available in the TSC2300. In other modes, the TSC2300 can be commanded to turn on the drivers only without performing a conversion. Time can then be allowed before the command is issued to perform a conversion.

The TSC2300 touch screen interface can measure position (X,Y) and pressure (Z). Determination of these coordinates is possible under three different modes of the A/D converter: conversion controlled by the TSC2300, initiated by detection of a touch; conversion controlled by the TSC2300, initiated by the host responding to the $\overline{\text{PENIRQ}}$ signal; or conversion completely controlled by the host processor.

A/D CONVERTER

The analog inputs of the TSC2300 are shown in Figure 47. The analog inputs (X, Y, and Z touch panel coordinates, battery voltage monitors, chip temperature and auxiliary inputs) are provided via a multiplexer to the successive approximation register (SAR) analog-to-digital (A/D) converter. The A/D architecture is based on capacitive redistribution architecture which inherently includes a sample/hold function.

A unique configuration of low on-resistance switches allows an unselected ADC input channel to provide power and an accompanying pin to provide ground for driving the touch panel. By maintaining a differential input to the converter and a differential reference input architecture, it is possible to negate errors caused by the driver switch on-resistances.

The A/D is controlled by an A/D converter control register. Several modes of operation are possible, depending upon the bits set in the control register. Channel selection, scan operation, averaging, resolution, and conversion rate may all be programmed through this register. These modes are outlined in the sections below for each type of analog input. The results of conversions made are stored in the appropriate result register.

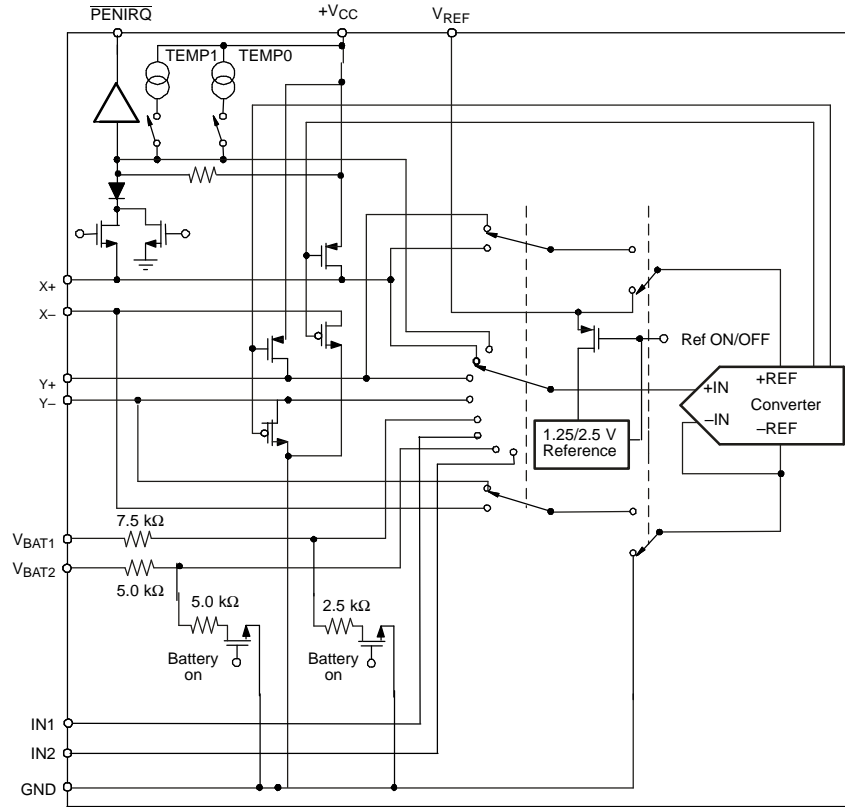
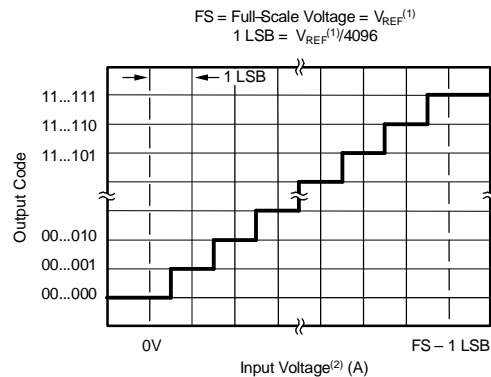

Figure 47. Simplified Diagram of the Touch Screen Analog Input Section

Data Format

The TSC2300 output data is in straight binary format as shown in Figure 48. This figure shows the ideal output code for the given input voltage and does not include the effects of offset, gain, or noise.



NOTES: (1) Reference voltage at converter: +REF-(−REF). See Figure 4.
 (2) Input voltage at converter, after multiplexer: +IN-(−IN). See Figure 4

Figure 48. Ideal Input Voltages and Output Codes.

Reference

The TSC2300 has an internal voltage reference that can be set to 1.2 V or 2.5 V, through the reference control register. This reference can also be set to automatically power down between conversions to save power, or remain on to reduce settling time.

The internal reference voltage is only used in the single-ended mode for battery monitoring, temperature measurement, and for utilizing the auxiliary inputs. Optimal touch screen performance is achieved when using a ratiometric conversion, thus all touch screen measurements are done automatically in the differential mode.

An external reference can also be applied to the VREFIN pin, and the internal reference can be turned off.

TSC2300

SLAS372 — NOVEMBER 2002

Variable Resolution

The TSC2300 provides three different resolutions for the A/D converter: 8, 10 or 12 bits. Lower resolutions are often practical for measurements such as touch pressure. Performing the conversions at lower resolution reduces the amount of time it takes for the A/D converter to complete its conversion process, which lowers power consumption.

Conversion Clock and Conversion Time

The TSC2300 contains an internal 8-MHz clock, which is used to drive the state machines inside the device that perform the many functions of the part. This clock is divided down to generate the actual A/D conversion clock. The division ratio for this clock is set in the A/D converter control register. The ability to change the conversion clock rate allows the user to choose the optimal value for resolution, speed, and power. If the 8-MHz clock is used directly, the A/D converter is limited to 8-bit resolution; using higher resolutions at this speed will not result in accurate conversions. Using a 4-MHz conversion clock is suitable for 10-bit resolution; 12-bit resolution requires that the conversion clock run at 1 or 2 MHz.

Regardless of the conversion clock speed, the internal clock runs nominally at 8 MHz. The conversion time of the TSC2300 is dependent upon several functions. While the conversion clock speed plays an important role in the time it takes for a conversion to complete, a certain number of internal clock cycles is needed for proper sampling of the signal. Moreover, additional times, such as the panel voltage stabilization time, can add significantly to the time it takes to perform a conversion. Conversion time can vary depending upon the mode in which the TSC2300 is used. Throughout this data sheet, internal and conversion clock cycles are used to describe the times that many functions take. In considering the total system design, these times must be taken into account by the user.

Touch Detect

The pen interrupt ($\overline{\text{PENIRQ}}$) output function is detailed in Figure 49. While in the touch screen monitoring mode, the Y-driver is ON and connected to GND, the X+ input is connected through a pullup resistor to V_{DD} , and the $\overline{\text{PENIRQ}}$ output reflects the state of the X+ input. When the panel is touched, the X+ input is pulled to ground through the touch screen and $\overline{\text{PENIRQ}}$ output goes LOW due to the current path through the panel to GND, initiating an interrupt to the processor. During the measurement cycles for X- and Y-position, the X+ input is disconnected from $\overline{\text{PENIRQ}}$ to eliminate any leakage current from the pullup resistor that might flow through the touch screen, thus causing no errors.

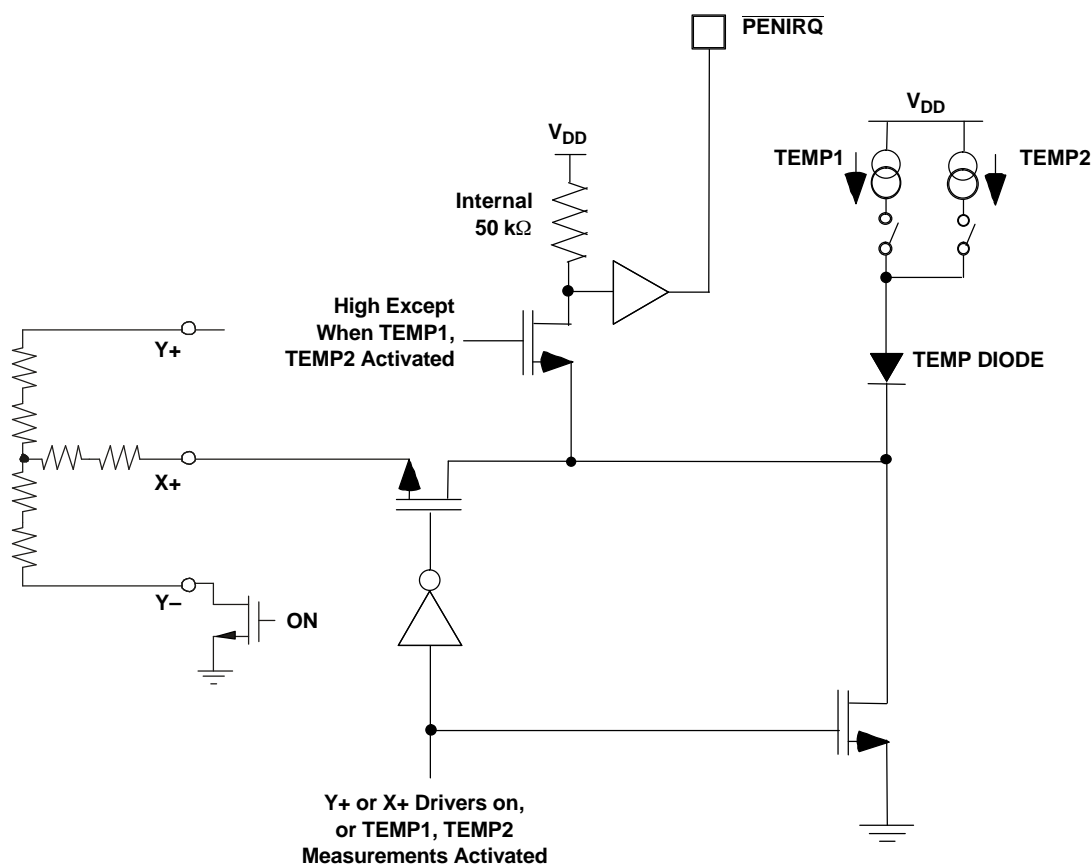

Figure 49. $\overline{\text{PENIRQ}}$ Functional Block Diagram.

In modes where the TSC2300 needs to detect if the screen is still touched (for example, when doing a PENIRQ-initiated X, Y, and Z conversion), the TSC2300 must reconnect the drivers so that the 50-kΩ resistor is connected again. Because of the high value of this pullup resistor, any capacitance on the touch screen inputs cause a long delay time, and may prevent the detection from occurring correctly. To prevent this, the TSC2300 has a circuit which allows any screen capacitance to be precharged through a low-resistance connection to VDD, so that the pullup resistor doesn't have to be the only source for the charging current. The time allowed for this precharge, as well as the time needed to sense if the screen is still touched, can be set in the configuration control register. All other drivers (X-,Y+, Y-) are off during precharging.

This does point out, however, the need to use the minimum capacitor values possible on the touch screen inputs. These capacitors may be needed to reduce noise, but too large a value increases the needed precharge and sense times, as well as panel voltage stabilization time.

In self-controlled modes where the TSC2300 automatically performs conversions when it detects a pen touch, it is generally not necessary for the host processor to monitor PENIRQ. Instead, the host should monitor DAV, which goes low when data is available in the appropriate data register, and returns high when all new data has been read back by the host.

DIGITAL INTERFACE

The TSC2300 communicates through a standard SPI bus. The SPI allows full-duplex, synchronous, serial communication between a host processor (the master) and peripheral devices (slaves). The SPI master generates the synchronizing clock and initiates transmissions. The SPI slave devices depend on a master to start and synchronize transmissions.

A transmission begins when initiated by a SPI master. The byte from the SPI master begins shifting in on the slave MOSI pin under the control of the master serial clock. As the byte shifts in on the MOSI pin, a byte shifts out on the MISO pin to the master shift register.

The idle state of the serial clock for the TSC2300 is LOW, which corresponds to a clock polarity setting of 0 (typical microprocessor SPI control bit CPOL = 0). The TSC2300 interface is designed so that with a clock phase bit setting of 1 (typical microprocessor SPI control bit CPHA = 1), the master begins driving its MOSI pin and the slave begins driving its MISO pin on the first serial clock edge. The SS pin can remain low between transmissions; however, the TSC2300 only interprets the first 16 bits transmitted after the falling edge of SS as a command word, and the next 16 bits as a data word only if writing to a register. Reserved register bits should be written to their default values (see Table 5).

TSC2300 Communication Protocol

The TSC2300 is entirely controlled by registers. Reading and writing these registers is accomplished by the use of a 16-bit command, which is sent prior to the data for that register. The command is constructed as shown in Table 3.

The command word begins with an R/W bit, which specifies the direction of data flow on the serial bus. The following 4 bits specify the page of memory this command is directed to, as shown in Table 2. The next six bits specify the register address on that page of memory to which the data is directed. The last five bits are reserved for future use.

Table 2. Page Addressing

PG3	PG2	PG1	PG0	PAGE ADDRESSED
0	0	0	0	0
0	0	0	1	1
0	0	1	0	2
0	0	1	1	reserved
0	1	0	0	reserved
0	1	0	1	reserved
0	1	1	0	reserved
0	1	1	1	reserved
1	0	0	0	reserved
1	0	0	1	reserved
1	0	1	0	reserved
1	0	1	1	reserved

TSC2300

SLAS372 — NOVEMBER 2002

Page Addressing (continued)

PG3	PG2	PG1	PG0	PAGE ADDRESSED
1	1	0	0	reserved
1	1	0	1	reserved
1	1	1	0	reserved
1	1	1	1	reserved

To read all the first page of memory, for example, the host processor must send the TSC2300 the command 0x8000 - this specifies a read operation beginning at page 0, address 0. The processor can then start clocking data out of the TSC2300. The TSC2300 automatically increments its address pointer to the end of the page; if the host processor continues clocking data out past the end of a page, the TSC2300 simply sends back the value 0xFFFF.

Continuous writing is generally not recommended for the control registers, but for the coefficients of BBCF registers, continuous writing works. Writing to these registers consists of the processor writing the command 0x10E0, which specifies a write operation, with PG1 set to 1, and the ADDR bits set to 07h. This results in the address pointer pointing at the location of the first bass-boost coefficient in memory see Table 4(Page 2). See the section on the TSC2300 memory map for details of register locations

Table 3. TSC2300 Command Word

BIT 15 MSB	BIT 14	BIT 13	BIT 12	BIT 11	BIT 10	BIT 9	BIT 8	BIT 7	BIT 6	BIT 5	BIT 4	BIT 3	BIT 2	BIT 1	BIT 0 LSB
R/W*	PG3	PG2	PG1	PG0	ADDR5	ADDR4	ADDR3	ADDR2	ADDR1	ADDR0	X	X	X	X	X

Figure 50 shows an example of a complete data transaction between the host processor and the TSC2300.

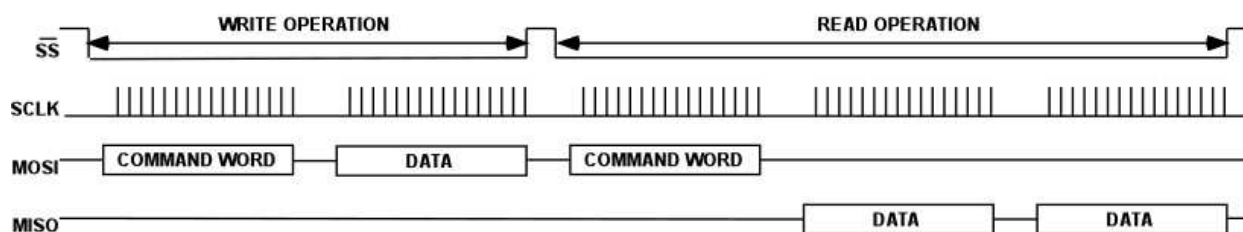

Figure 50. Write and Read Operation of TSC2300 Interface.

TSC2300 MEMORY MAP

The TSC2300 has several 16-bit registers which allow control of the device as well as providing a location for results from the TSC2300 to be stored until read by the host microprocessor. These registers are separated into three pages of memory in the TSC2300: a data page (Page 0), a control page (Page 1), and an audio control page (Page 2). The memory map is shown in Table 4.

Table 4. TSC2300 Memory Map

PAGE 0: DATA REGISTERS		PAGE 1: CONTROL REGISTERS		PAGE 2: AUDIOCONTROL REGISTERS	
ADDR	REGISTER	ADDR	REGISTER	ADDR	REGISTER
00	X	00	ADC	00	Audio control
01	Y	01	KEY	01	ADC volume control
02	Z1	02	DACCTL	02	DAC volume control
03	Z2	03	REF	03	Analog audio bypass volume control
04	KPData	04	RESET	04	Keyclick control
05	BAT1	05	CONFIG	05	Audio power/ crystal oscillator control
06	BAT2	06	CONFIG2	06	GPIO control
07	AUX1	07	reserved	07	DAC bass-boost filter coefficients
08	AUX2	08	reserved	08	DAC bass-boost filter coefficients
09	TEMP1	09	reserved	09	DAC bass-boost filter coefficients
0A	Temp2T1	0A	reserved	0A	DAC bass-boost filter coefficients
0B	DAC	0B	reserved	0B	DAC bass-boost filter coefficients
0C	reserved	0C	reserved	0C	DAC bass-boost filter coefficients
0D	reserved	0D	reserved	0D	DAC bass-boost filter coefficients
0E	reserved	0E	reserved	0E	DAC bass-boost filter coefficients
0F	reserved	0F	reserved1	0F	DAC bass-boost filter coefficients
10	reserved	10	KPMask1	10	DAC bass-boost filter coefficients
11	reserved	11	reserved1	11	DAC bass-boost filter coefficients
12	reserved	12	reserved	12	DAC bass-boost filter coefficients
13	reserved	13	reserved	13	DAC bass-boost filter coefficients
14	reserved	14	reserved	14	DAC bass-boost filter coefficients
15	reserved	15	reserved	15	DAC bass-boost filter coefficients
16	reserved	16	reserved	16	DAC bass-boost filter coefficients
17	reserved	17	reserved	17	DAC bass-boost filter coefficients
18	reserved	18	reserved	18	DAC bass-boost filter coefficients
19	reserved	19	reserved	19	DAC bass-boost filter coefficients
1A	reserved	1A	reserved	1A	DAC bass-boost filter coefficients
1B	reserved	1B	reserved	1B	reserved
1C	reserved	1C	reserved	1C	reserved
1D	reserved	1D	reserved	1D	reserved
1E	reserved	1E	reserved	1E	reserved
1F	reserved	1F	reserved	1F	reserved

TSC2300

SLAS372 — NOVEMBER 2002

TSC2300 REGISTER OVERVIEW

Table 5. Register Summary for TSC2300

PAGE	ADDR (HEX)	REGISTER NAME	D15	D14	D13	D12	D11	D10	D9	D8	D7	D6	D5	D4	D3	D2	D1	D0	RESET VALUE (HEX)
0	00	X	0	0	0	0	R11	R10	R9	R8	R7	R6	R5	R4	R3	R2	R1	R0	0000
0	01	Y	0	0	0	0	R11	R10	R9	R8	R7	R6	R5	R4	R3	R2	R1	R0	0000
0	02	Z1	0	0	0	0	R11	R10	R9	R8	R7	R6	R5	R4	R3	R2	R1	R0	0000
0	03	Z2	0	0	0	0	R11	R10	R9	R8	R7	R6	R5	R4	R3	R2	R1	R0	0000
0	04	KPDATA	K15	K14	K13	K12	K11	K10	K9	K8	K7	K6	K5	K4	K3	K2	K1	K0	0000
0	05	BAT1	0	0	0	0	R11	R10	R9	R8	R7	R6	R5	R4	R3	R2	R1	R0	0000
0	06	BAT2	0	0	0	0	R11	R10	R9	R8	R7	R6	R5	R4	R3	R2	R1	R0	0000
0	07	AUX1	0	0	0	0	R11	R10	R9	R8	R7	R6	R5	R4	R3	R2	R1	R0	0000
0	08	AUX2	0	0	0	0	R11	R10	R9	R8	R7	R6	R5	R4	R3	R2	R1	R0	0000
0	09	TEMP1	0	0	0	0	R11	R10	R9	R8	R7	R6	R5	R4	R3	R2	R1	R0	0000
0	0A	Temp2T1	0	0	0	0	R11	R10	R9	R8	R7	R6	R5	R4	R3	R2	R1	R0	0000
0	0B	DAC	0	0	0	0	0	0	0	0	D7	D6	D5	D4	D3	D2	D1	D0	0080
0	0C	reserved	1	1	1	1	1	1	1	1	1	1	1	1	1	1	1	1	FFFF
0	0D	reserved	1	1	1	1	1	1	1	1	1	1	1	1	1	1	1	1	FFFF
0	0E	reserved	1	1	1	1	1	1	1	1	1	1	1	1	1	1	1	1	FFFF
0	0F	reserved	1	1	1	1	1	1	1	1	1	1	1	1	1	1	1	1	FFFF
0	10	reserved	1	1	1	1	1	1	1	1	1	1	1	1	1	1	1	1	FFFF
0	11	reserved	1	1	1	1	1	1	1	1	1	1	1	1	1	1	1	1	FFFF
0	12	reserved	1	1	1	1	1	1	1	1	1	1	1	1	1	1	1	1	FFFF
0	13	reserved	1	1	1	1	1	1	1	1	1	1	1	1	1	1	1	1	FFFF
0	14	reserved	1	1	1	1	1	1	1	1	1	1	1	1	1	1	1	1	FFFF
0	15	reserved	1	1	1	1	1	1	1	1	1	1	1	1	1	1	1	1	FFFF
0	16	reserved	1	1	1	1	1	1	1	1	1	1	1	1	1	1	1	1	FFFF
0	17	reserved	1	1	1	1	1	1	1	1	1	1	1	1	1	1	1	1	FFFF
0	18	reserved	1	1	1	1	1	1	1	1	1	1	1	1	1	1	1	1	FFFF
0	19	reserved	1	1	1	1	1	1	1	1	1	1	1	1	1	1	1	1	FFFF
0	1A	reserved	1	1	1	1	1	1	1	1	1	1	1	1	1	1	1	1	FFFF
0	1B	reserved	1	1	1	1	1	1	1	1	1	1	1	1	1	1	1	1	FFFF
0	1C	reserved	1	1	1	1	1	1	1	1	1	1	1	1	1	1	1	1	FFFF
0	1D	reserved	1	1	1	1	1	1	1	1	1	1	1	1	1	1	1	1	FFFF
0	1E	reserved	1	1	1	1	1	1	1	1	1	1	1	1	1	1	1	1	FFFF
0	1F	reserved	1	1	1	1	1	1	1	1	1	1	1	1	1	1	1	1	FFFF
1	00	ADC	PSM	STS	AD3	AD2	AD1	AD0	RS1	RS0	AV1	AV0	CL1	CL0	PV2	PV1	PV0	0	4000
1	01	KEY	STC	SCS	DB2	DB1	DB0	0	0	0	0	0	0	0	0	0	0	0	4000
1	02	DACCTL	DPD	0	0	0	0	0	0	0	0	0	0	0	0	0	0	0	8000
1	03	REF	0	0	0	0	0	0	0	0	0	0	0	INT	DL1	DL0	PDN	RFV	0002
1	04	RESET	1	0	1	1	1	0	1	1	1	1	1	1	1	1	1	1	FFFF
1	05	CONFIG	1	1	1	1	1	1	1	1	1	1	PR2	PR1	PR0	SN2	SN1	SN0	FFC0
1	06	CONFIG2	SDAV	1	1	1	1	1	1	1	1	1	1	1	1	1	1	1	FFFF
1	07	reserved	1	1	1	1	1	1	1	1	1	1	1	1	1	1	1	1	FFFF
1	08	reserved	1	1	1	1	1	1	1	1	1	1	1	1	1	1	1	1	FFFF
1	09	reserved	1	1	1	1	1	1	1	1	1	1	1	1	1	1	1	1	FFFF
1	0A	reserved	1	1	1	1	1	1	1	1	1	1	1	1	1	1	1	1	FFFF
1	0B	reserved	1	1	1	1	1	1	1	1	1	1	1	1	1	1	1	1	FFFF
1	0C	reserved	1	1	1	1	1	1	1	1	1	1	1	1	1	1	1	1	FFFF
1	0D	reserved	1	1	1	1	1	1	1	1	1	1	1	1	1	1	1	1	FFFF
1	0E	reserved	1	1	1	1	1	1	1	1	1	1	1	1	1	1	1	1	FFFF
1	0F	reserved	1	1	1	1	1	1	1	1	1	1	1	1	1	1	1	1	FFFF
1	10	KPMASK	M15	M14	M13	M12	M11	M10	M9	M8	M7	M6	M5	M4	M3	M2	M1	M0	0000
1	11	reserved	1	1	1	1	1	1	1	1	1	1	1	1	1	1	1	1	FFFF
1	12	reserved	1	1	1	1	1	1	1	1	1	1	1	1	1	1	1	1	FFFF
1	13	reserved	1	1	1	1	1	1	1	1	1	1	1	1	1	1	1	1	FFFF

Register Summary for TSC2300 (continued)

PAGE	ADDR (HEX)	REGISTER NAME	D15	D14	D13	D12	D11	D10	D9	D8	D7	D6	D5	D4	D3	D2	D1	D0	RESET VALUE (HEX)
1	14	reserved	1	1	1	1	1	1	1	1	1	1	1	1	1	1	1	1	FFFF
1	15	reserved	1	1	1	1	1	1	1	1	1	1	1	1	1	1	1	1	FFFF
1	16	reserved	1	1	1	1	1	1	1	1	1	1	1	1	1	1	1	1	FFFF
1	17	reserved	1	1	1	1	1	1	1	1	1	1	1	1	1	1	1	1	FFFF
1	18	reserved	1	1	1	1	1	1	1	1	1	1	1	1	1	1	1	1	FFFF
1	19	reserved	1	1	1	1	1	1	1	1	1	1	1	1	1	1	1	1	FFFF
1	1A	reserved	1	1	1	1	1	1	1	1	1	1	1	1	1	1	1	1	FFFF
1	1B	reserved	1	1	1	1	1	1	1	1	1	1	1	1	1	1	1	1	FFFF
1	1C	reserved	1	1	1	1	1	1	1	1	1	1	1	1	1	1	1	1	FFFF
1	1D	reserved	1	1	1	1	1	1	1	1	1	1	1	1	1	1	1	1	FFFF
1	1E	reserved	1	1	1	1	1	1	1	1	1	1	1	1	1	1	1	1	FFFF
1	1F	reserved	1	1	1	1	1	1	1	1	1	1	1	1	1	1	1	1	FFFF
2	00	AUDCNTRL	HPF1	HPF0	INM1	INM0	0	0	MICG1	MICG0	MCLK1	MCLK0	I2SFS3	I2SFS2	I2SFS1	I2SFS0	I2SF1	I2SF0	C003
2	01	ADCVOL	ADMU	ADV6	ADV5	ADV4	ADV3	ADV2	ADV1	ADV0	1	1	0	1	0	1	1	1	D7D7
2	02	DACVOL	DAMUL	DAVL6	DAVL5	DAVL4	DAVL3	DAVL2	DAVL1	DAVL0	DAMUR	DAVR6	DAVR5	DAVR4	DAVR3	DAVR2	DAVR1	DAVR0	FFFF
2	03	BPVOL	BPMUL	BPVL6	BPVL5	BPVL4	BPVL3	BPVL2	BPVL1	BPVL0	BPMUR	BPVR6	BPVR5	BPVR4	BPVR3	BPVR2	BPVR1	BPVR0	E7E7
2	04	KEYCLICK	KEYST	KCAM2	KCAM1	KCAM0	0	KCFR2	KCFR1	KCFR0	KCLN3	KCLN2	KCLN1	KCLN0	0	MONS	SSRTE	SSSTEP	4411
2	05	PD/MISC	APD	AVPD	ABPD	HAPD	MOPD	DAPD	ADPD	1	PDSTS	MIBPD	OSCC	BCKC	SMPD	OTSYN	BASS	DEEMP	FFA4
2	06	GPIO	0	0	IO5	IO4	IO3	IO2	IO1	IO0	0	0	GPIO5	GPIO4	GPIO3	GPIO2	GPIO1	GPIO0	0000
2	07	BBCFN0L	CF15	CF14	CF13	CF12	CF11	CF10	CF9	CF8	CF7	CF6	CF5	CF4	CF3	CF2	CF1	CF0	6BE2
2	08	BBCFN1L	CF15	CF14	CF13	CF12	CF11	CF10	CF9	CF8	CF7	CF6	CF5	CF4	CF3	CF2	CF1	CF0	9667
2	09	BBCFN2L	CF15	CF14	CF13	CF12	CF11	CF10	CF9	CF8	CF7	CF6	CF5	CF4	CF3	CF2	CF1	CF0	675D
2	0A	BBCFN3L	CF15	CF14	CF13	CF12	CF11	CF10	CF9	CF8	CF7	CF6	CF5	CF4	CF3	CF2	CF1	CF0	6BE2
2	0B	BBCFN4L	CF15	CF14	CF13	CF12	CF11	CF10	CF9	CF8	CF7	CF6	CF5	CF4	CF3	CF2	CF1	CF0	9667
2	0C	BBCFN5L	CF15	CF14	CF13	CF12	CF11	CF10	CF9	CF8	CF7	CF6	CF5	CF4	CF3	CF2	CF1	CF0	675D
2	0D	BBCFD1L	CF15	CF14	CF13	CF12	CF11	CF10	CF9	CF8	CF7	CF6	CF5	CF4	CF3	CF2	CF1	CF0	7D82
2	0E	BBCFD2L	CF15	CF14	CF13	CF12	CF11	CF10	CF9	CF8	CF7	CF6	CF5	CF4	CF3	CF2	CF1	CF0	84EF
2	0F	BBCFD4L	CF15	CF14	CF13	CF12	CF11	CF10	CF9	CF8	CF7	CF6	CF5	CF4	CF3	CF2	CF1	CF0	7D82
2	10	BBCFD5L	CF15	CF14	CF13	CF12	CF11	CF10	CF9	CF8	CF7	CF6	CF5	CF4	CF3	CF2	CF1	CF0	84EF
2	11	BBCFN0R	CF15	CF14	CF13	CF12	CF11	CF10	CF9	CF8	CF7	CF6	CF5	CF4	CF3	CF2	CF1	CF0	6BE2
2	12	BBCFN1R	CF15	CF14	CF13	CF12	CF11	CF10	CF9	CF8	CF7	CF6	CF5	CF4	CF3	CF2	CF1	CF0	9667
2	13	BBCFN2R	CF15	CF14	CF13	CF12	CF11	CF10	CF9	CF8	CF7	CF6	CF5	CF4	CF3	CF2	CF1	CF0	675D
2	14	BBCFN3R	CF15	CF14	CF13	CF12	CF11	CF10	CF9	CF8	CF7	CF6	CF5	CF4	CF3	CF2	CF1	CF0	6BE2
2	15	BBCFN4R	CF15	CF14	CF13	CF12	CF11	CF10	CF9	CF8	CF7	CF6	CF5	CF4	CF3	CF2	CF1	CF0	9667
2	16	BBCFN5R	CF15	CF14	CF13	CF12	CF11	CF10	CF9	CF8	CF7	CF6	CF5	CF4	CF3	CF2	CF1	CF0	675D
2	17	BBCFD1R	CF15	CF14	CF13	CF12	CF11	CF10	CF9	CF8	CF7	CF6	CF5	CF4	CF3	CF2	CF1	CF0	7D82
2	18	BBCFD2R	CF15	CF14	CF13	CF12	CF11	CF10	CF9	CF8	CF7	CF6	CF5	CF4	CF3	CF2	CF1	CF0	84EF
2	19	BBCFD4R	CF15	CF14	CF13	CF12	CF11	CF10	CF9	CF8	CF7	CF6	CF5	CF4	CF3	CF2	CF1	CF0	7D82
2	1A	BBCFD5R	CF15	CF14	CF13	CF12	CF11	CF10	CF9	CF8	CF7	CF6	CF5	CF4	CF3	CF2	CF1	CF0	84EF
2	1B	reserved	0	0	0	0	0	1	0	0	0	0	0	0	0	0	0	0	0400
2	1C	reserved	1	1	1	1	1	1	1	1	1	1	1	1	1	1	1	1	FFFF
2	1D	reserved	0	0	0	0	0	0	0	0	0	0	0	0	0	0	0	0	0000
2	1E	reserved	0	0	0	0	0	0	0	0	0	0	0	0	0	0	0	0	0000
2	1F	reserved	0	1	0	0	0	0	0	0	0	0	0	0	0	0	0	0	4000

TSC2300

SLAS372 — NOVEMBER 2002

TSC2300 TOUCH SCREEN CONTROL REGISTERS

This section describes each of the registers shown in the memory map of Figure 54. The registers are grouped according to the function they control. Note that in the TSC2300, bits in control registers may refer to slightly different functions depending upon if you are reading the register or writing to it. A summary of all registers and bit locations is shown in Table 5.

TSC2300 A/D Converter Control Register (Page 1, Address 00H)

The A/D converter in the TSC2300 is shared between all the different functions. A control register determines which input is selected, as well as other options. The result of the conversion is placed in one of the result registers in Page 0 of memory, depending upon the function selected.

The A/D Converter Control Register controls several aspects of the A/D converter. The register is formatted as follows:

BIT 15 MSB	BIT 14	BIT 13	BIT 12	BIT 11	BIT 10	BIT 9	BIT 8	BIT 7	BIT 6	BIT 5	BIT 4	BIT 3	BIT 2	BIT 1	BIT 0 LSB
PSM	STS	AD3	AD2	AD1	AD0	RS1	RS0	AV1	AV0	CL1	CL0	PV2	PV1	PV0	X

Bit 15 — PSM

Pen Status/Control Mode. Reading this bit allows the host to determine if the screen is touched. Writing to this bit determines the mode used to read coordinates: host controlled or under control of the TSC2300 responding to a screen touch. When reading, the PENSTS bit indicates if the pen is down or not. When writing to this register, this bit determines if the TSC2300 controls the reading of coordinates, or if the coordinate conversions are host-controlled. The default state is host-controlled conversions (0).

Table 6. PSM Bit Operation

PSM		
READ/WRITE	VALUE	DESCRIPTION
Read	0	No screen touch detected (default)
Read	1	Screen touch detected
Write	0	Conversions controlled by host
Write	1	Conversions controlled by TSC2300

Bit 14 — STS

A/D Status. Reading this bit indicates if the converter is busy. Writing a 0 to this bit causes the touch screen scans to continue until either the pen is lifted or the process is stopped. Continuous scans or conversions can be stopped by writing a 1 to this bit. This immediately halts a conversion (even if the pen is still down) and causes the A/D to power down. The default state is continuous conversions, but if this bit is read after a reset or power-up, it reads 1.

Table 7. STS Bit Operation

STS		
READ/WRITE	VALUE	DESCRIPTION
Read	0	Converter is busy
Read	1	Converter is not busy (default)
Write	0	Normal operation
Write	1	Stop conversion and power down

Bits [13:10] — AD3 - AD0

A/D Function Select bits. These bits control which input is to be converted, and what mode the converter is placed in. These bits are the same whether reading or writing. See Table 8 for a complete listing of how these bits are used.

Table 8. A/D Function Select

A/D3	A/D2	A/D1	A/D0	FUNCTION
0	0	0	0	Invalid. No registers are updated. This is the default state after a reset.
0	0	0	1	Touch screen scan function: X and Y coordinates converted and the results returned to X and Y data registers. Scan continues until either the pen is lifted or a stop bit is sent.
0	0	1	0	Touch screen scan function: X, Y, Z1 and Z2 coordinates converted and the results returned to X, Y, Z1 and Z2 data registers. Scan continues until either the pen is lifted or a stop bit is sent.
0	0	1	1	Touch screen scan function: X coordinate converted and the results returned to X data register.
0	1	0	0	Touch screen scan function: Y coordinate converted and the results returned to Y data register.
0	1	0	1	Touch screen scan function: Z1 and Z2 coordinates converted and the results returned to Z1 and Z2 data registers.
0	1	1	0	Battery Input 1 converted and the results returned to the BAT1 data register.
0	1	1	1	Battery Input 2 converted and the results returned to the BAT2 data register.
1	0	0	0	Auxiliary Input 1 converted and the results returned to the AUX1 data register.
1	0	0	1	Auxiliary Input 2 converted and the results returned to the AUX2 data register.
1	0	1	0	A temperature measurement is made and the results returned to the temperature measurement 1 data register.
1	0	1	1	Port scan function: Battery Input 1, Battery Input 2, Auxiliary Input 1, and Auxiliary Input 2 measurements are made and the results returned to the appropriate data registers
1	1	0	0	A differential temperature measurement is made and the results returned to the temperature measurement 2 data register.
1	1	0	1	Turn on X+, X- drivers
1	1	1	0	Turn on Y+, Y- drivers
1	1	1	1	Turn on Y+, X- drivers

Bits[9:8] — RS1, RS0

Resolution Control. The A/D converter resolution is specified with these bits. See Table 9 for a description of these bits. These bits are the same whether reading or writing.

Table 9. A/D Converter Resolution Control

RS1	RS0	FUNCTION
0	0	12-bit resolution. Power up and reset default.
0	1	8-bit resolution
1	0	10-bit resolution
1	1	12-bit resolution

Bits[7:6] — AV1, AV0

Converter Averaging Control. These two bits (see Table 10) allow you to specify the number of averages the converter performs. Note that when averaging is used, the STS/STP bit and the DAV output indicates that the converter is busy until all conversions necessary for the averaging are complete. The default state for these bits is 00, selecting no averaging. These bits are the same whether reading or writing.

Table 10. A/D Conversion Averaging Control

AV1	AV0	FUNCTION
0	0	None (one conversion) (default)

TSC2300

SLAS372 — NOVEMBER 2002

A/D Conversion Averaging Control (continued)

AV1	AV0	FUNCTION
0	1	4 data averages
1	0	8 data averages
1	1	16 data averages

Bits[5:4] — CL1, CL0

Conversion Clock Control. These two bits specify the internal clock rate which the A/D converter uses when performing a conversion. See Table 11. These bits are the same whether reading or writing.

Table 11. A/D Converter Conversion Clock Control

CL1	CL0	FUNCTION
0	0	8-MHz internal clock rate - 8-bit resolution only (default)
0	1	4-MHz internal clock rate - 8- or 10-bit resolution only
1	0	2-MHz internal clock rate
1	1	1-MHz internal clock rate

Bits [3:1] — PV2 - PV0

Panel Voltage Stabilization Time control. These bits allow the user to specify a delay time from when a driver is turned on to the time sampling begins and a conversion is started. In self-controlled mode, when a pen touch is detected, the part first turns on a driver, waits a programmed delay time set by PV2-PV0, and then begins sampling and A/D conversion. See Table 12 for settings of these bits. The default state is 000, indicating a 0µs stabilization time. These bits are the same whether reading or writing.

Table 12. Panel Voltage Stabilization Time Control

PV2	PV1	PV0	STABILIZATION TIME
0	0	0	0 µsec. (default)
0	0	1	100 µsec.
0	1	0	500 µsec.
0	1	1	1 msec.
1	0	0	5 msec.
1	0	1	10 msec.
1	1	0	50 msec.
1	1	1	100 msec.

Bit 0

This bit is reserved. When read, it always reads as a zero.

DAC Control Register (Page 1, Address 02H)

The single bit in this register controls the power down control of the onboard digital-to-analog converter (DAC). This register is formatted as follows:

BIT 15 MSB	BIT 14	BIT 13	BIT 12	BIT 11	BIT 10	BIT 9	BIT 8	BIT 7	BIT 6	BIT 5	BIT 4	BIT 3	BIT 2	BIT 1	BIT 0 LSB
DPD	X	X	X	X	X	X	X	X	X	X	X	X	X	X	X

Bit 15 — DPD

DAC Power Down. This bit controls whether the DAC is powered up and operational, or powered down. If the DAC is powered down, the AOUT pin neither sinks nor sources current.

Table 13. DPD Bit Operation

DPD	
VALUE	DESCRIPTION
0	DAC is powered and operational
1	DAC is powered down. (default)

Reference Register (Page 1, Address 03H)

This register controls whether the TSC2300 uses an internal or external reference, and if the internal reference is used, the value of the reference voltage, whether it powers down between conversions and the programmable settling time after reference power-up. This register is formatted as follows:

BIT 15 MSB	BIT 14	BIT 13	BIT 12	BIT 11	BIT 10	BIT 9	BIT 8	BIT 7	BIT 6	BIT 5	BIT 4	BIT 3	BIT 2	BIT 1	BIT 0 LSB
X	X	X	X	X	X	X	X	X	X	X	INT	DL1	DL0	PDN	RFV

Bit 4 —INT

Internal Reference Mode. If this bit is written to a 1, the TSC2300 uses its internal reference; if this bit is a 0, the part assumes an external reference is being supplied. The default state for this bit is to select an external reference (0). This bit is the same whether reading or writing.

Table 14. INT Bit Operation

INT	
VALUE	DESCRIPTION
0	External reference selected (default)
1	Internal reference selected

Bits [3:2] — DL1, DL0

Reference Power-Up Delay. When the internal reference is powered up, a finite amount of time is required for the reference to settle. If measurements are made before the reference has settled, these measurements are in error. These bits allow for a delay time for measurements to be made after the reference powers up, thereby assuring that the reference has settled. Longer delays are necessary depending upon the capacitance present at the VREFIN pin (see Typical Curves). The delays are shown in Table 15. The default state for these bits is 00, selecting a 0 microsecond delay. These bits are the same whether reading or writing.

Table 15. Reference Power-Up Delay Settings.

DL1	DL0	DELAY TIME
0	0	0us (default)
0	1	100 μs
1	0	500 μs
1	1	1000 μs

Bit 1 —PDN

Reference Power Down. If a 1 is written to this bit, the internal reference are powered down between conversions. If this bit is a zero, the internal reference is powered at all times. The default state is to power down the internal reference, so this bit will be a 1. This bit is the same whether reading or writing.

Table 16. PDN Bit Operation

PDN	
VALUE	DESCRIPTION
0	Internal reference is powered at all times
1	Internal reference is powered down between conversions. (default)

Note that the PDN bit, in concert with the INT bit, creates a few possibilities for reference behavior. These are detailed in Table 17.

Table 17. Reference Behavior Possibilities

INT	PDN	REFERENCE BEHAVIOR
0	0	External reference used, internal reference powered down.
0	1	External reference used, internal reference powered down.
1	0	Internal reference used, always powered up
1	1	Internal reference used, powers up during conversions and then powers down.

Bit 0 — RFV

Reference Voltage control. This bit selects the internal reference voltage, either 1.2 V or 2.5 V. The default value is 1.2 V. This bit is the same whether reading or writing.

Table 18. RFV Bit Operation

RFV	
Value	Description
0	1.2-V reference voltage (default)
1	2.5-V reference voltage

TSC2300 Configuration Control Register (Page 1, Address 05H)

This control register controls the configuration of the precharge and sense times for the touch detect circuit. The register is formatted as follows:

Bit 15 MSB	Bit 14	Bit 13	Bit 12	Bit 11	Bit 10	Bit 9	Bit 8	Bit 7	Bit 6	Bit 5	Bit 4	Bit 3	Bit 2	Bit 1	Bit 0 LSB
RES	RES	RES	RES	RES	RES	RES	RES	RES	RES	PRE2	PRE1	PRE0	SNS2	SNS1	SNS0

Bits [5:3] — PRE[2:0]

Precharge time selection bits. These bits set the amount of time allowed for precharging any pin capacitance on the touch screen prior to sensing if the screen is being touched.

Table 19. Precharge Times

PRE[2:0]			
PRE2	PRE1	PRE0	TIME
0	0	0	20 μ s (default)
0	0	1	84 μ s
0	1	0	276 μ s
0	1	1	340 μ s
1	0	0	1.044 ms

Precharge Times (continued)

PRE[2:0]			
PRE2	PRE1	PRE0	TIME
1	0	1	1.108 ms
1	1	0	1.300 ms
1	1	1	1.364 ms

Bits [2:0] — SNS[2:0]

Sense time selection bits. These bits set the amount of time the TSC2300 will wait to sense a screen touch between coordinate axis conversions in self-controlled mode.

Table 20. Sense Times

SNS[2:0]			
SNS2	SNS1	SNS0	TIME
0	0	0	32 μ s (default)
0	0	1	96 μ s
0	1	0	544 μ s
0	1	1	608 μ s
1	0	0	2.080 ms
1	0	1	2.144 ms
1	1	0	2.592 ms
1	1	1	2.656 ms

TSC2300

SLAS372 — NOVEMBER 2002

TSC2300 KEYPAD REGISTERS

The keypad scanner hardware in the TSC2300 is controlled by two registers: the keypad control register and the keypad mask register. The keypad control register controls general keypad functions such as scanning and de-bouncing, while the keypad mask register allows you to mask certain keys from being detected at all.

Keypad Control Register (Page 1, Address 01H)

The Keypad Control register is formatted as follows:

BIT 15 MSB	BIT 14	BIT 13	BIT 12	BIT 11	BIT 10	BIT 9	BIT 8	BIT 7	BIT 6	BIT 5	BIT 4	BIT 3	BIT 2	BIT 1	BIT 0 LSB
STC	SCS	DB2	DB1	DB0	X	X	X	X	X	X	X	X	X	X	X

Bit 15 — STC

Keypad Status. This bit reflects the operation of the $\overline{\text{KBIRQ}}$ pin, with inverted logic. This bit goes high when a key is pressed and debounced. The default value for this bit is 0.

Table 21. STC Bit Operation

STC	
VALUE	DESCRIPTION
0	No keys are pressed (default)
1	Key pressed and debounced

Bit 14 — SCS

Keypad Scan Status. When reading, this bit indicates if the scanner or de-bouncer is busy. Writing a 0 to this bit causes keypad scans to continue until either the key is lifted or the process is stopped. Continuous scans can be stopped by writing a 1 to this bit. This immediately halts a conversion (even if a key is still down). The default value for this bit when read is 1.

Table 22. SCS Bit Operation

SCS		
READ/WRITE	VALUE	DESCRIPTION
Read	0	Scanner or de-bouncer busy
Read	1	Scanner not busy (default)
Write	0	Normal operation
Write	1	Stop scans

Bits [13:11] — KBDB2-KBDB0

Keypad De-bounce Control. These bits set the length of the de-bounce time for the keypad, as shown in Table 23. The default setting is a 2-mS de-bounce time (000).

Table 23. Keypad De-bounce Control

KBDB2	KBDB1	KBDB0	Function
0	0	0	De-bounce: 2 ms (default)
0	0	1	De-bounce: 10 ms
0	1	0	De-bounce: 20 ms
0	1	1	De-bounce: 50 ms
1	0	0	De-bounce: 60 ms
1	0	1	De-bounce: 80 ms

Keypad De-bounce Control (continued)

KBDB2	KBDB1	KBDB0	Function
1	1	0	De-bounce: 100 ms
1	1	1	De-bounce: 120 ms

Keypad Mask Register (Page 1, Address 10H)

The Keypad Mask register is formatted as follows:

BIT 15 MSB	BIT 14	BIT 13	BIT 12	BIT 11	BIT 10	BIT 9	BIT 8	BIT 7	BIT 6	BIT 5	BIT 4	BIT 3	BIT 2	BIT 1	BIT 0 LSB
M15	M14	M13	M12	M11	M10	M9	M8	M7	M6	M5	M4	M3	M2	M1	M0

This is the same format as used in the keypad data register (Page 0, Address 04H). Each bit in these registers represents one key on the keypad. In the mask register, if a bit is set (1), then that key is not detected in keypad scans. Pressing that key on the keypad also does not cause a \overline{KBIRQ} , if the bit is set. If the bit is cleared (0), the corresponding key is detected when pressed. A 16-key keypad is mapped into the keypad mask (and keypad data) register as shown in Table 24. The default value for this register is 0000H, detecting all key presses.

Table 24. Keypad to Key Bit Mapping.

	C1	C2	C3	C4
R1	K0	K1	K2	K3
R2	K4	K5	K6	K7
R3	K8	K9	K10	K11
R4	K12	K13	K14	K15

The result of a keypad scan appears in the keypad data register. Each bit is set in this register, corresponding to the key(s) actually pressed. For example, if only key 1 was pressed on a particular scan, the data in the register would read as 0x0002; however, if keys 6, 8, and 13 were all pressed simultaneously on that scan, the data would read as 0x2140.

Multiple keys may be pressed simultaneously, and are generally decoded correctly by the keypad scan circuitry. However, keys that land on three corners of a rectangle may cause a false reading of a key on the fourth corner of the rectangle. For example, if keys 0, 3, and 11 were pressed simultaneously, the KEY0, KEY3, and KEY11 bits are set, but the KEY8 bit is also set. Thus, when considering using multiple-key combinations in an application, try to avoid combinations that put three keys on the corners of a rectangle.

Secondary Configuration Register (Page 1, Address 06H):

This register allows the user to read the status of the \overline{DAV} pin through the SPI interface.

BIT 15 MSB	BIT 14	BIT 13	BIT 12	BIT 11	BIT 10	BIT 9	BIT 8	BIT 7	BIT 6	BIT 5	BIT 4	BIT 3	BIT 2	BIT 1	BIT 0 LSB
SDAV	X	X	X	X	X	X	X	X	X	X	X	X	X	X	X

Bit 15 — SDAV

SPI Data Available. This read-only bit mirrors the function of the \overline{DAV} pin. This bit is provided so that the host processor can poll the SPI interface to see whether data is available, without dedicating a GPIO pin from the host processor to the TSC2300 \overline{DAV} pin. This bit is normally high, goes low when touch screen or ADC data is available, and is reset high when all the new data has been read.

Table 25. SPI Data Available

TSC2300

SLAS372 — NOVEMBER 2002

SPI Data Available (continued)

SDAV	DESCRIPTION
0	Touch screen or SAR ADC data is available.
1	No new data available. (default)

Bits [14:0] — Reserved

These bits are reserved, and should be written to 0. If read, they will read back as 0.

Reset Register (Page 1, Address 04H):

The TSC2300 has a special register, the RESET register, which allows a software reset of the device. Writing the code 0xBB00, as shown below, to this register causes the TSC2300 to reset all its registers to their default, power-up values.

BIT 15 MSB	BIT 14	BIT 13	BIT 12	BIT 11	BIT 10	BIT 9	BIT 8	BIT 7	BIT 6	BIT 5	BIT 4	BIT 3	BIT 2	BIT 1	BIT 0 LSB
1	0	1	1	1	0	1	1	0	0	0	0	0	0	0	0

Other values should not be written to this register. Reading this register or any reserved register results in reading back all 1's, or 0xFFFF.

TSC2300 DATA REGISTERS

The data registers of the TSC2300 hold data results from conversions or keypad scans, or the value of the DAC output current. All of these registers default to 0000H upon reset, except the DAC register, which is set to 0080H, representing the midscale output of the DAC.

X, Y, Z1, Z2, BAT1, BAT2, AUX1, AUX2, TEMP1, AND TEMP2T1 REGISTERS

The results of all A/D conversions are placed in the appropriate data register, as described in Table 6 and Table 4. The data format of the result word, R, of these registers is right-justified, as follows (assuming a 12-bit conversion):

BIT 15 MSB	BIT 14	BIT 13	BIT 12	BIT 11	BIT 10	BIT 9	BIT 8	BIT 7	BIT 6	BIT 5	BIT 4	BIT 3	BIT 2	BIT 1	BIT 0 LSB
0	0	0	0	R11 MSB	R10	R9	R8	R7	R6	R5	R4	R3	R2	R1	R0 LSB

Keypad Data Register (Page 0, Address 04H)

The keypad data register (Page 0, Address 04H) is formatted as follows:

BIT 15 MSB	BIT 14	BIT 13	BIT 12	BIT 11	BIT 10	BIT 9	BIT 8	BIT 7	BIT 6	BIT 5	BIT 4	BIT 3	BIT 2	BIT 1	BIT 0 LSB
K15	K14	K13	K12	K11	K10	K9	K8	K7	K6	K5	K4	K3	K2	K1	K0

This is the same format as used in the keypad mask register (Page 1, Address 10H). Each bit in these registers represents one key on the keypad. A 16-key keypad is mapped into the keypad data register as shown in Table 24.

D/A Converter Data Register (Page 0, Address 0BH)

The data to be written to the D/A converter is written into the D/A converter data register, which is formatted as follows:

BIT 15 MSB	BIT 14	BIT 13	BIT 12	BIT 11	BIT 10	BIT 9	BIT 8	BIT 7	BIT 6	BIT 5	BIT 4	BIT 3	BIT 2	BIT 1	BIT 0 LSB
RES	RES	RES	RES	RES	RES	RES	RES	D7	D6	D5	D4	D3	D2	D1	D0

There are three different touch screen conversion modes available in the TSC2300: self-controlled or $\overline{\text{PENIRQ}}$ -Initiated, host-initiated, and host-controlled. These three modes are described below.

OPERATION - TOUCH SCREEN MEASUREMENTS

Conversion Controlled by TSC2300 Initiated at Touch Detect

In this mode, the TSC2300 detects when the touch panel is touched and causes the $\overline{\text{PENIRQ}}$ line to go low. At the same time, the TSC2300 powers up its internal clock. It then turns on the Y-drivers, and after a programmed panel voltage stabilization time, powers up the A/D converter and convert the Y coordinate. If averaging is selected, several conversions may take place; when data averaging is complete, the Y coordinate result is stored in the Y register.

This mode is recommended to fully utilize the integrated touch screen processing of the TSC2300 and reduce the processing overhead and number of interrupts to the host processor. In this mode, the host processor does not need to monitor $\overline{\text{PENIRQ}}$, instead the host needs only to configure the TSC2300 once at power-up, and then monitor $\overline{\text{DAV}}$ and read back data after a falling edge on $\overline{\text{DAV}}$.

If the screen is still touched at this time, the X-drivers are enabled, and the process repeats, but measures instead the X coordinate, storing the result in the X register.

If only X and Y coordinates are to be measured, then the conversion process is complete. Figure 51 shows a flowchart for this process. The time it takes to go through this process depends upon the selected resolution, internal conversion rate, averaging selected, panel voltage stabilization time, and precharge and sense times.

The time needed to get a complete X/Y coordinate reading can be calculated by:

$$t_{\text{coordinate}} = 2.5 \mu\text{s} + 2(t_{\text{PVS}} + t_{\text{PRE}} + t_{\text{SNS}}) + 2N_{\text{AVG}} \left(N_{\text{BITS}} \frac{1}{f_{\text{conv}}} + 4.4 \mu\text{s} \right) \quad (3)$$

where

- $t_{\text{coordinate}}$ = time to complete X/Y coordinate reading;
- t_{PVS} = panel voltage stabilization time, as given in Table 12;
- t_{PRE} = precharge time, as given in Table 19;
- t_{SNS} = sense time, as given in Table 20;
- N_{AVG} = number of averages, as given in Table 10; for no averaging, $N_{\text{AVG}} = 1$;
- N_{BITS} = number of bits of resolution, as given in Table 9;
- f_{conv} = A/D converter clock frequency, as given in Table 11.

If the pressure of the touch is also to be measured, the process continues after the X-conversion is complete, measuring the Z1 and Z2 values, and placing them in the Z1 and Z2 registers. This process is illustrated in Figure 55. As before, this process time depends upon the settings described above. The time for a complete X/Y/Z1/Z2 coordinate reading is given by:

$$t_{\text{coordinate}} = 4.75 \mu\text{s} + 3(t_{\text{PVS}} + t_{\text{PRE}} + t_{\text{SNS}}) + 4N_{\text{AVG}} \left(N_{\text{BITS}} \frac{1}{f_{\text{conv}}} + 4.4 \mu\text{s} \right) \quad (4)$$

Touch Screen Scan X and Y PENIRQ Initiated

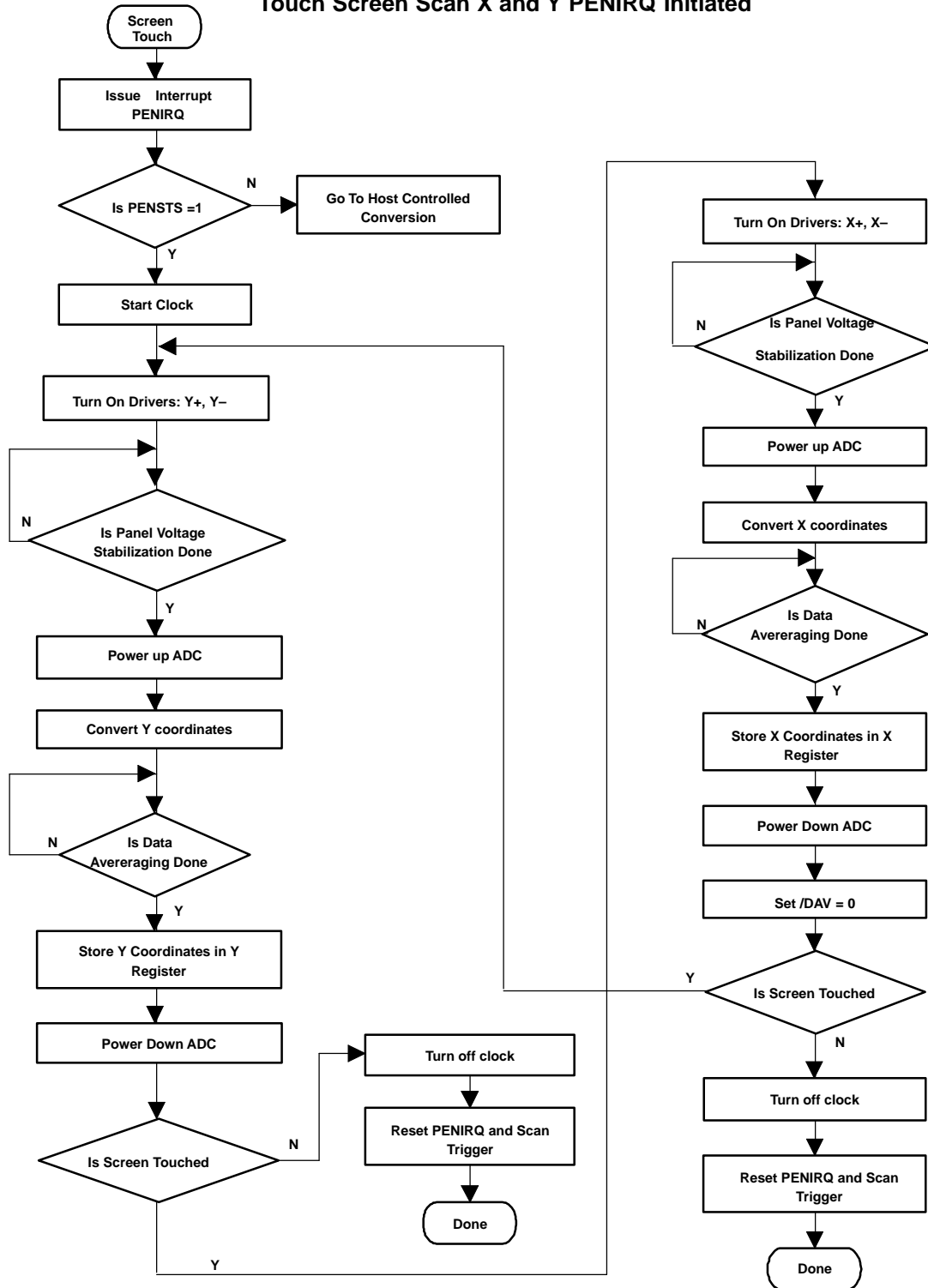

Figure 51. X & Y coordinate touch screen scan, initiated by touch.

Touch Screen Scan X, Y and Z PENIRQ Initiated

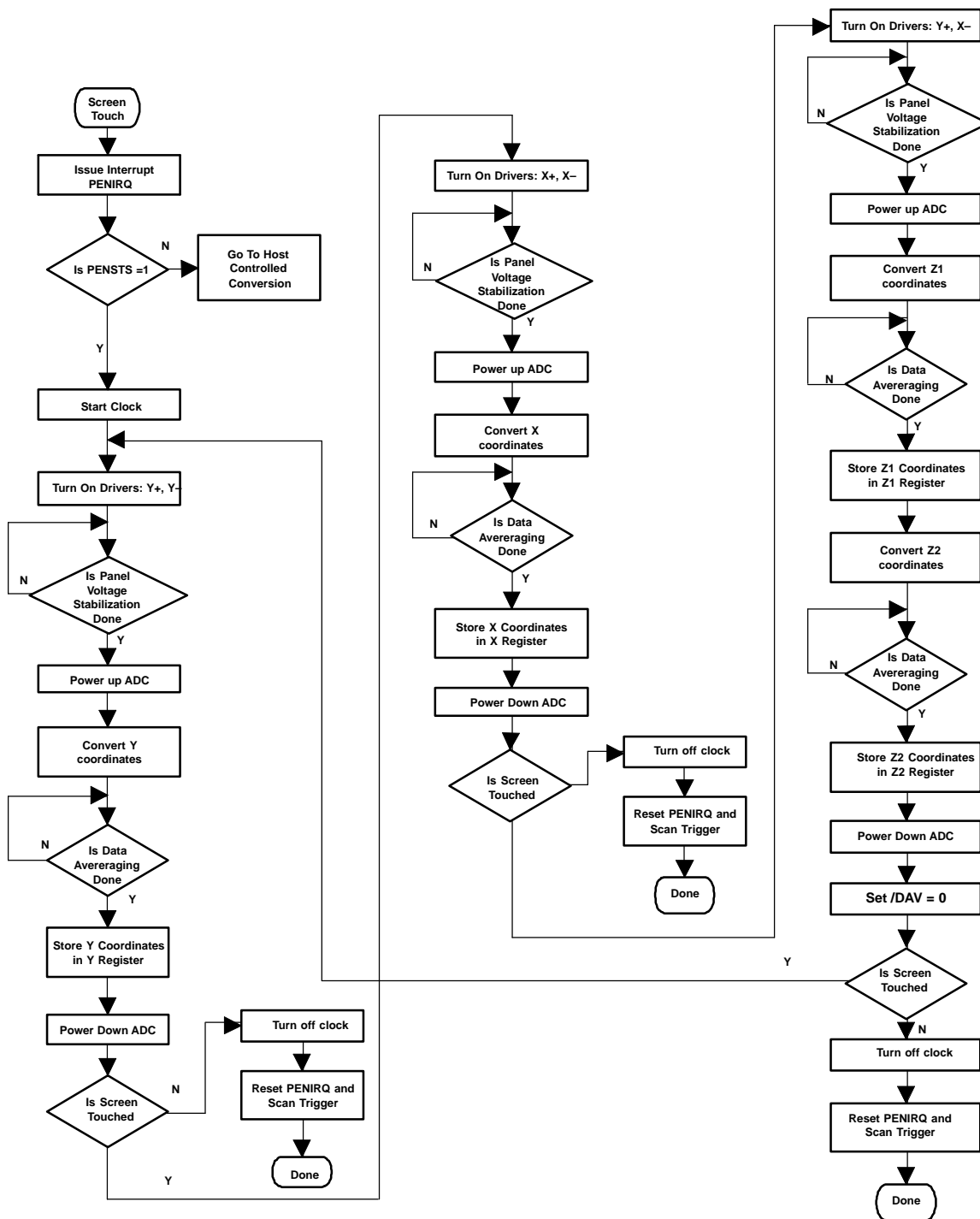

Figure 52. X,Y and Z Coordinate Touch Screen Scan, Initiated by Touch.

Conversion Controlled by TSC2300 Initiated By Host Responding to PENIRQ

This mode is provided for users who want more control over the A/D conversion process. This mode requires more overhead from the host processor, so it is generally not recommended.

TSC2300

SLAS372 — NOVEMBER 2002

In this mode, the TSC2300 detects when the touch panel is touched and causes the $\overline{\text{PENIRQ}}$ line to go low. The host recognizes the interrupt request, and then writes to the A/D Converter Control register to select one of the touch screen scan functions (single X-, Y-, or Z-conversions, continuous X/Y or X/Y/Z1/Z2 Conversions). The conversion process then proceeds as described above, and as outlined in Figure 53 through Figure 57.

The main difference between this mode and the previous mode is that the host, not the TSC2300, decides when the touch screen scan begins after responding to a $\overline{\text{PENIRQ}}$. In this mode, the host must either monitor both $\overline{\text{PENIRQ}}$ and $\overline{\text{DAV}}$, or wait a minimum time after writing to the A/D converter control register. This wait time can be calculated from Equations (5) in the case of single conversions, or from Equations (3) or (4) in the case of multiple conversions. The nominal conversion times calculated by these equations should be extended by approximately 12% to account for variation in the internal oscillator frequency.

Touch Screen Scan X and Y Host Initiated

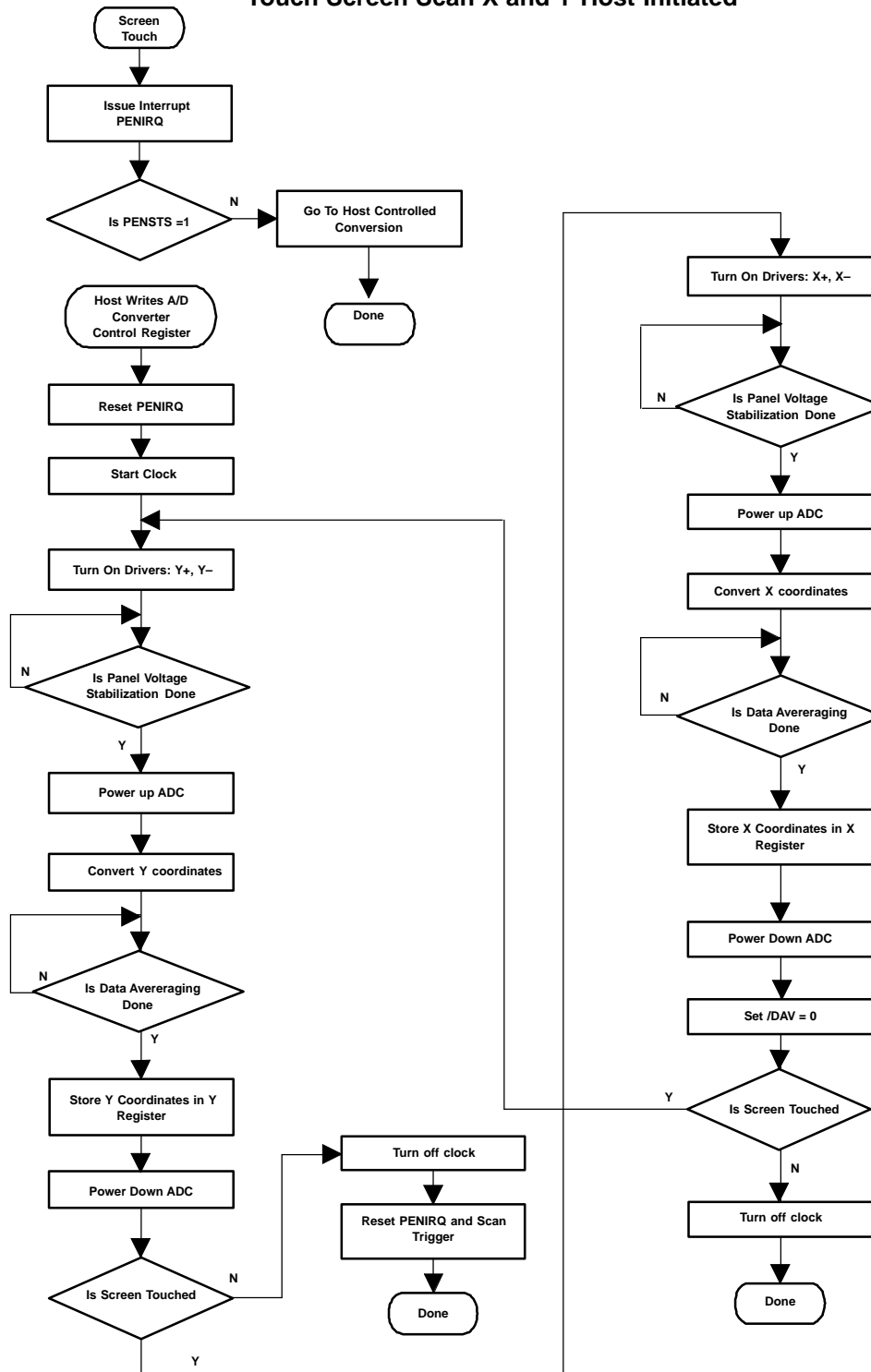

Figure 53. X and Y Coordinate Touch Screen Scan, Initiated by Host.

Touch Screen Scan X, Y and Z Host Initiated

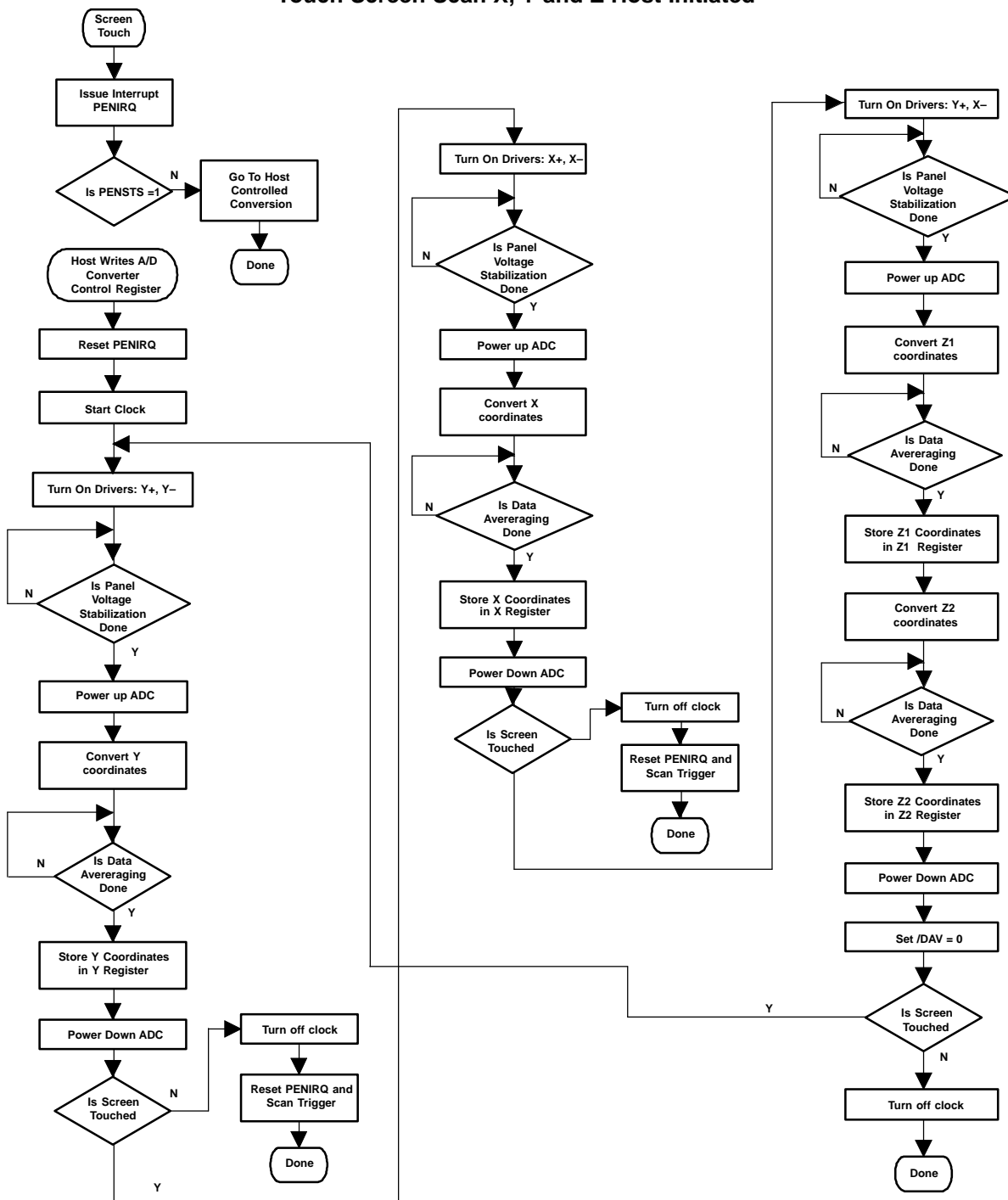

Figure 54. X,Y and Z Coordinate Touch Screen Scan, Initiated by Host.

Touch Screen Scan X Coordinate Host Initiated

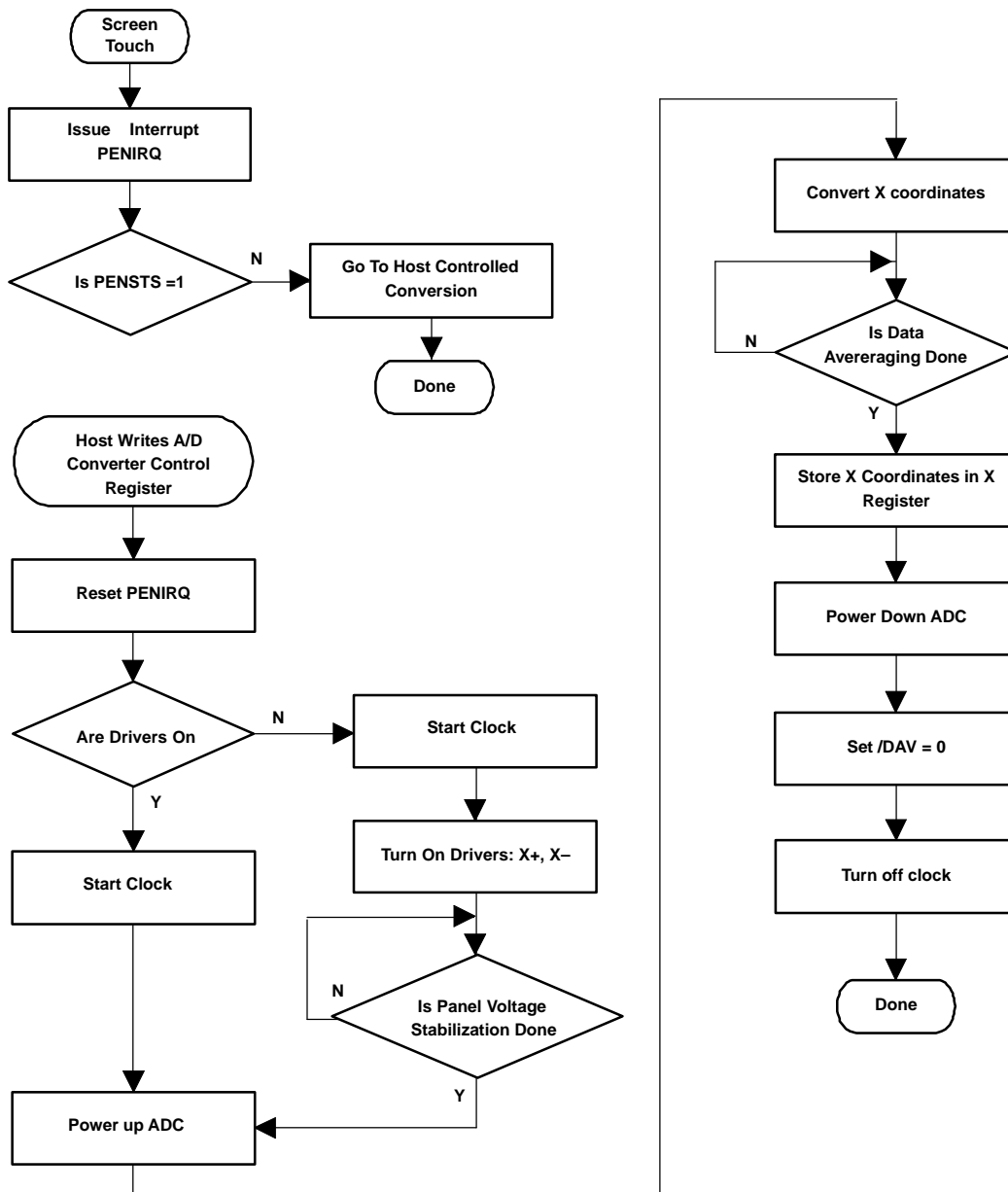

Figure 55. X Coordinate Reading Initiated by Host.

Touch Screen Scan Y Coordinate Host Initiated

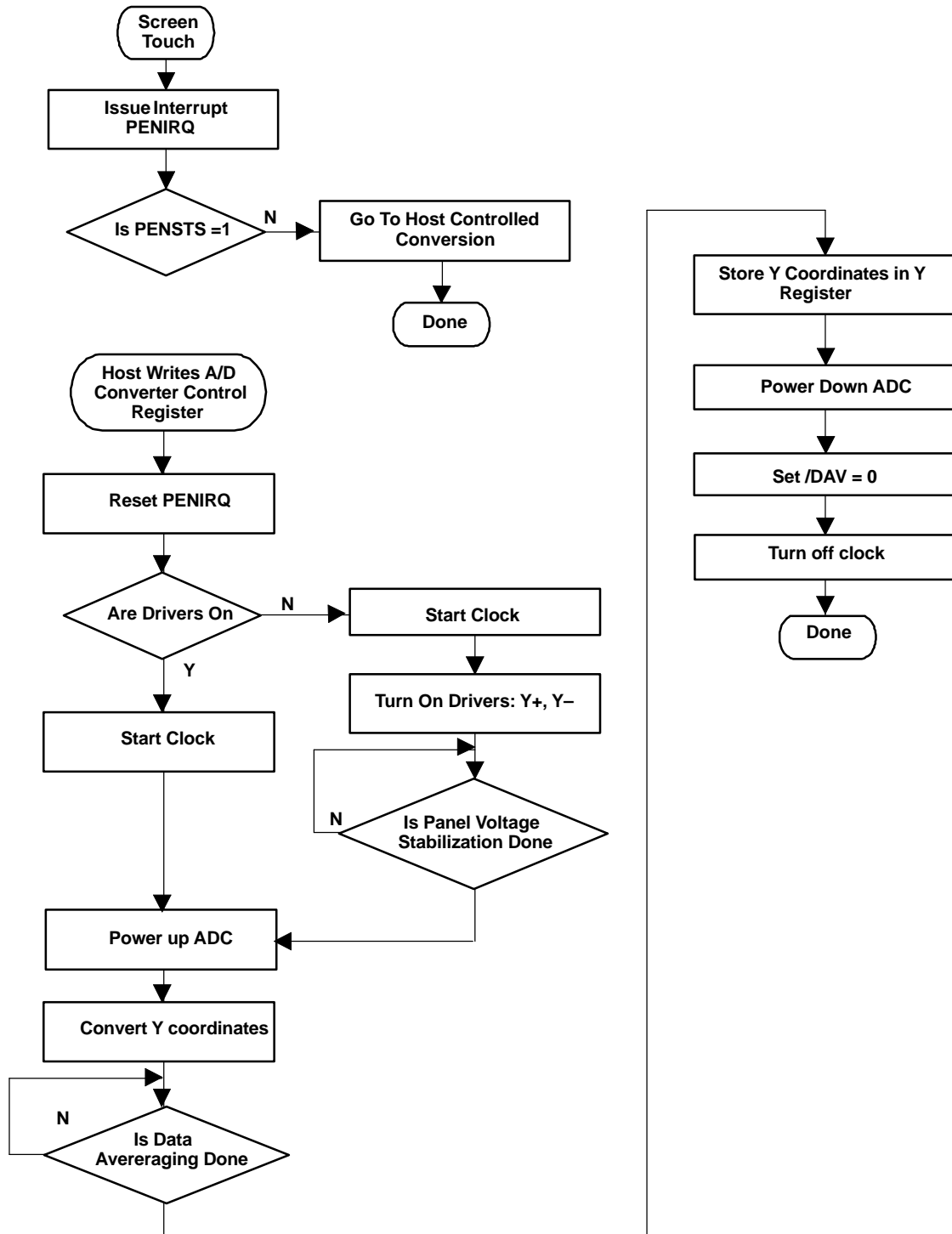

Figure 56. Y Coordinate Reading Initiated by Host.

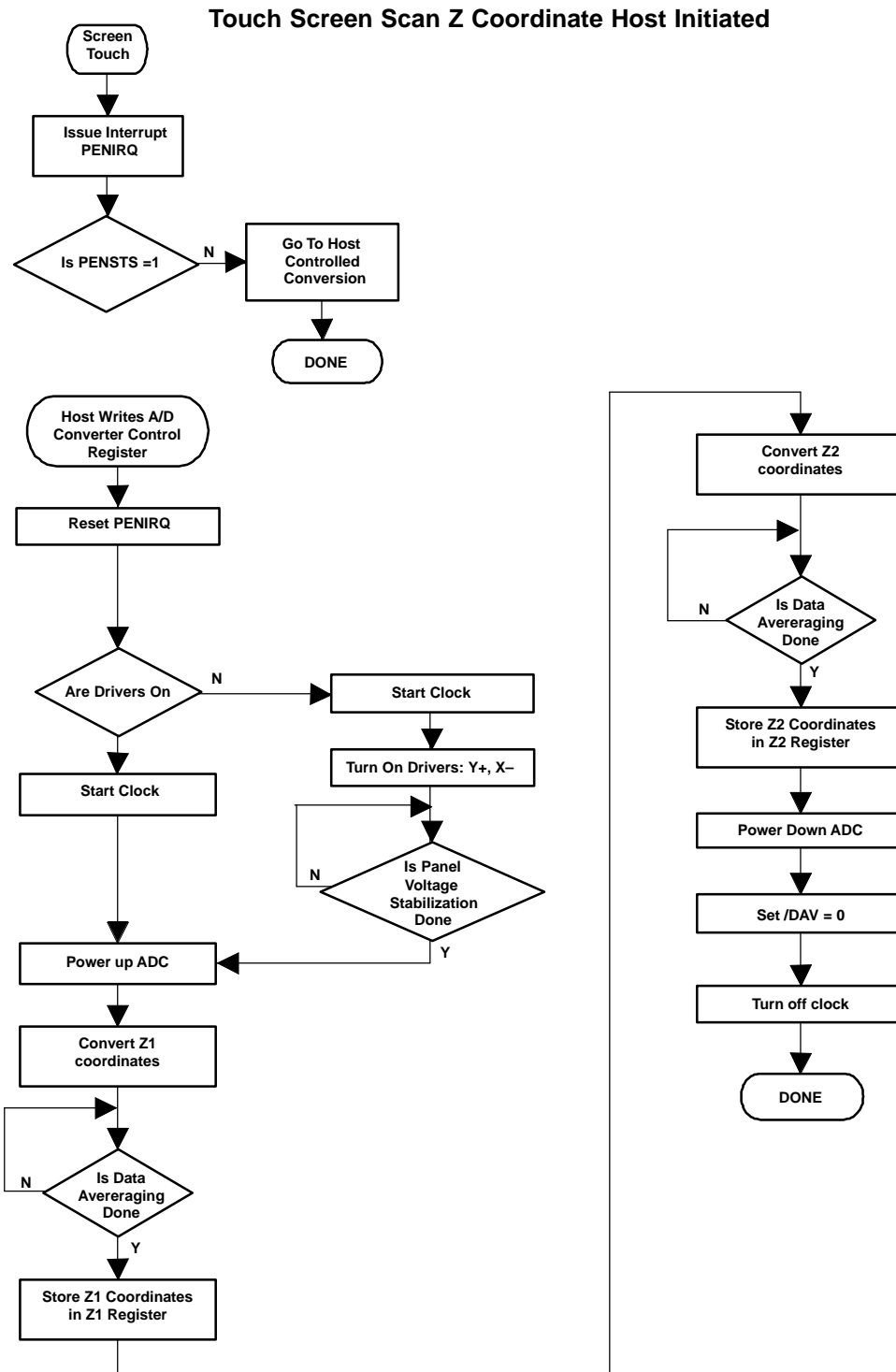

Figure 57. Z Coordinate Reading Initiated by Host.

Conversion Controlled by the Host

In this mode, the TSC2300 detects when the touch panel is touched and causes the $\overline{\text{PENIRQ}}$ line to go low. The host recognizes the interrupt request. Instead of starting a sequence in the TSC2300 which then reads each coordinate in turn, the host now must control all aspects of the conversion. An example sequence would be: (a) $\overline{\text{PENIRQ}}$ goes low when screen is touched. (b) Host writes to TSC2300 to turn on X-drivers. (c) Host waits a desired delay for panel voltage stabilization. (d) Host writes to TSC2300 to begin X-conversion. After waiting for the settling time, the host then addresses the TSC2300 again, this time requesting an X coordinate conversion.

TSC2300

SLAS372 — NOVEMBER 2002

The process is then repeated for Y and Z coordinates. The processes are outlined in Figure 58 through Figure 60.

The time needed to convert any single coordinate under host control (not including the time needed to send the command over the SPI bus) is given by:

$$t_{\text{coordinate}} = 2.125 \mu\text{s} + t_{\text{PVS}} + N_{\text{AVG}} \left(N_{\text{BITS}} \frac{1}{f_{\text{conv}}} + 4.4 \mu\text{s} \right) \quad (5)$$

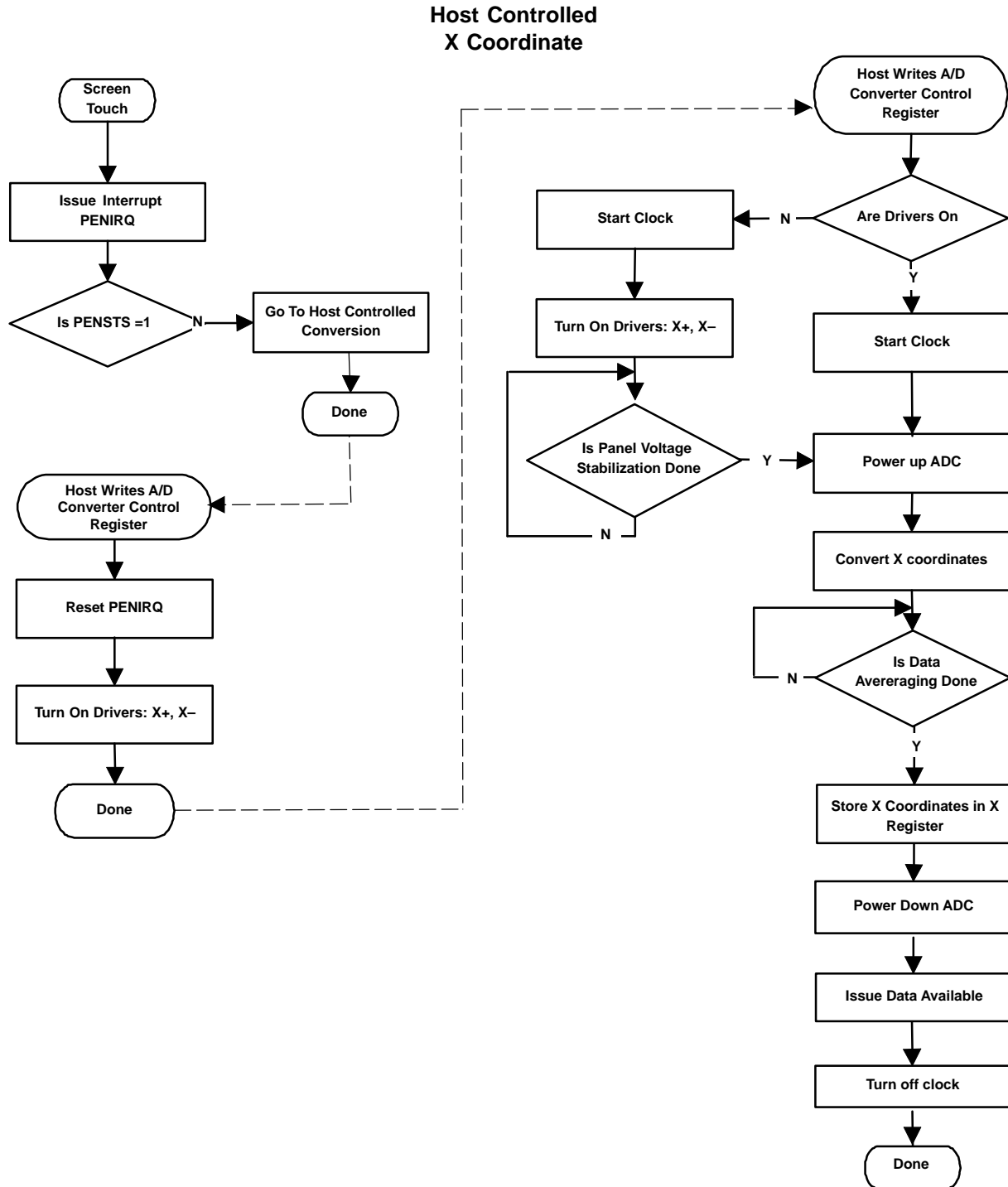

Figure 58. X Coordinate Reading Controlled by Host.

Host Controlled
Y Coordinate

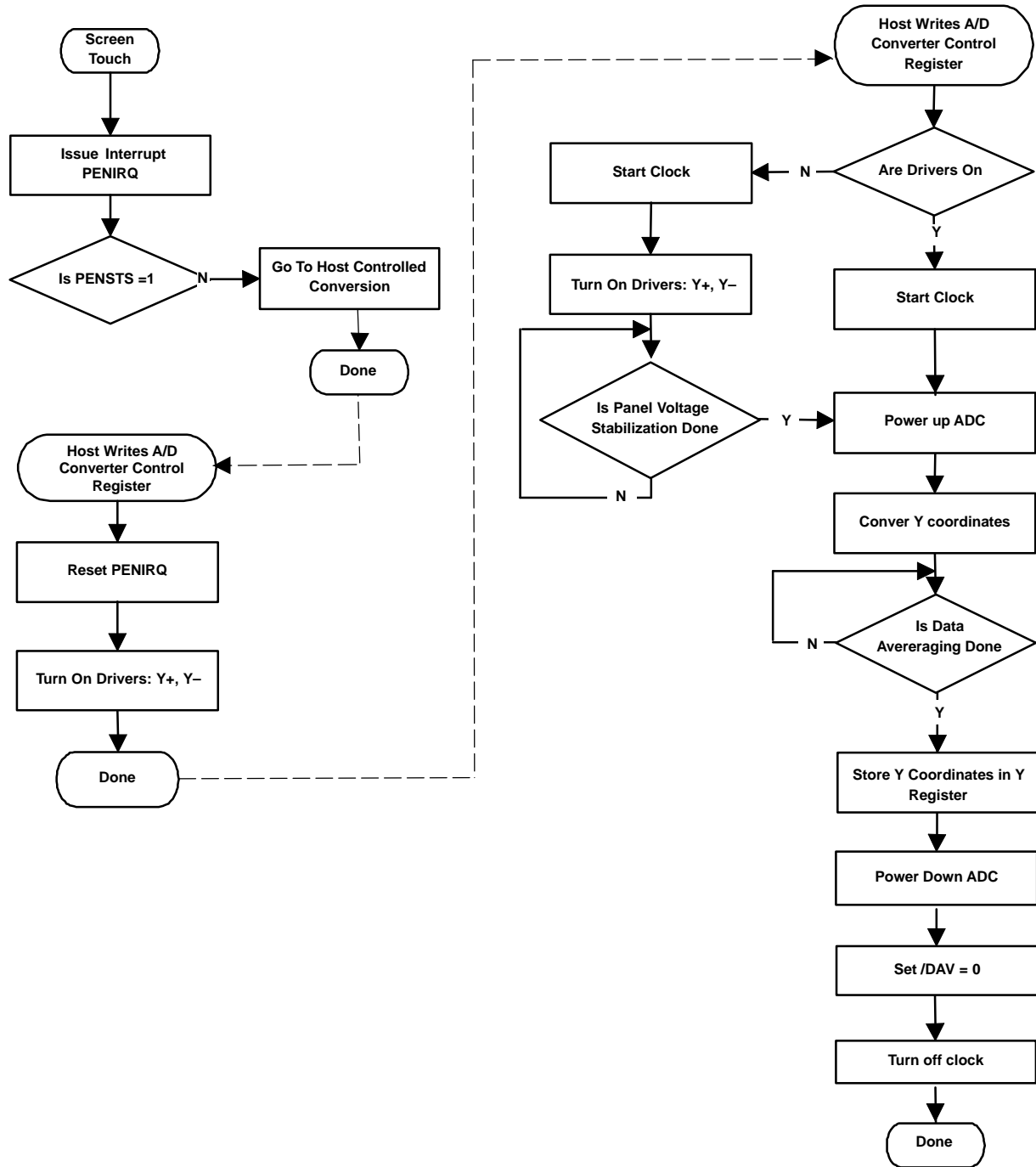

Figure 59. Y Coordinate Reading Controlled by Host.

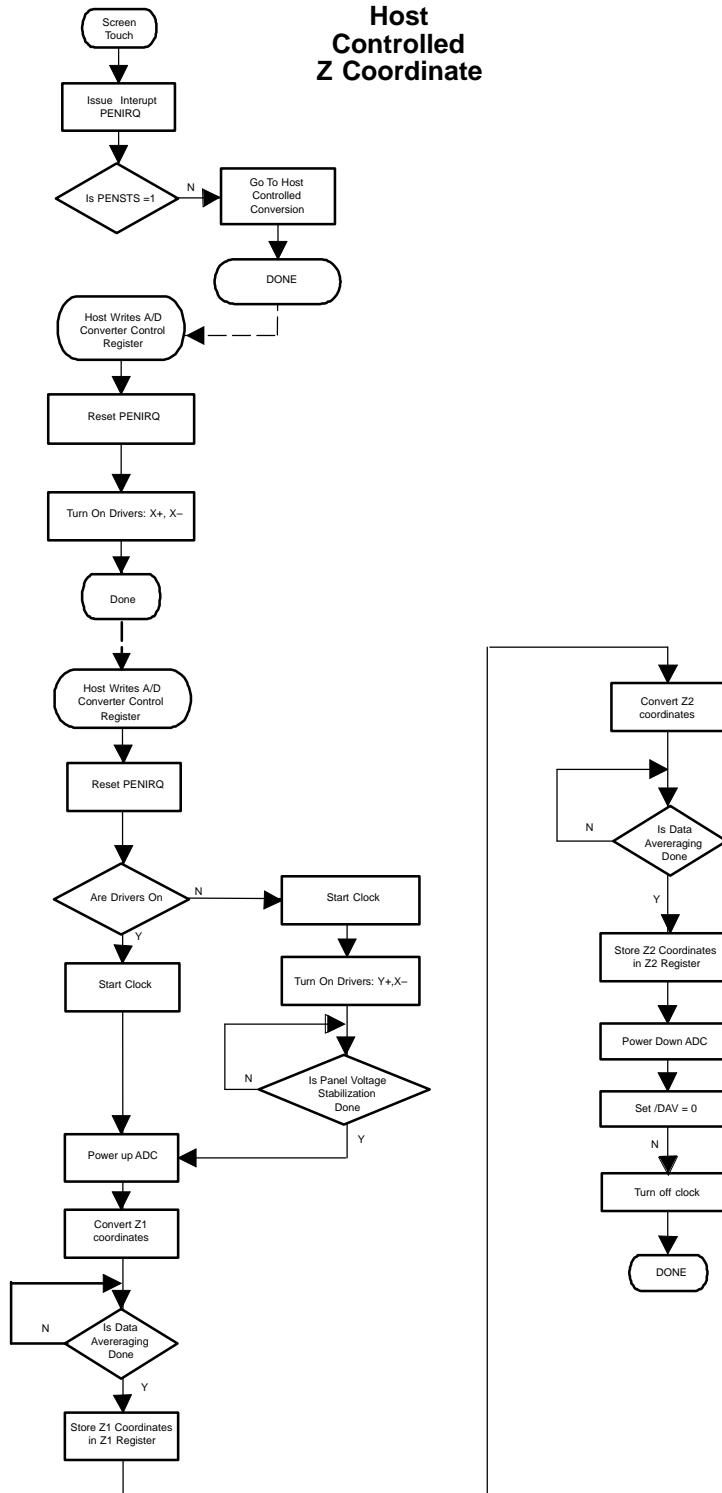

Figure 60. Z Coordinate Reading Controlled by Host.

OPERATION - TEMPERATURE MEASUREMENT

In some applications, such as estimating remaining battery life or setting RAM refresh rate, a measurement of ambient temperature is required. The temperature measurement technique used in the TSC2300 relies on the characteristics of a semiconductor junction operating at a fixed current level. The forward diode voltage (V_{BE}) has a well-defined characteristic versus temperature. The ambient temperature can be predicted in applications by knowing the 25°C value of the V_{BE} voltage and then monitoring the delta of that voltage as the temperature changes.

The TSC2300 offers two modes of temperature measurement. The first mode requires calibration at a known temperature, but only requires a single reading to predict the ambient temperature. A diode, as shown in Figure 61, is used during this measurement cycle. The voltage across this diode is typically 600 mV at +25°C while conducting a 20- μ A current. The absolute value of this diode voltage can vary several millivolts, but the temperature coefficient (TC) of this voltage is very consistent at -2.1 mV/°C. During the final test of the end product, the diode voltage would be measured by the TSC2300's ADC at a known room temperature, and the corresponding digital code stored in system memory, for calibration purposes by the user. The result is an equivalent temperature measurement resolution of 0.3°C/LSB. This measurement of what is referred to as Temperature 1 is illustrated in Figure 62.

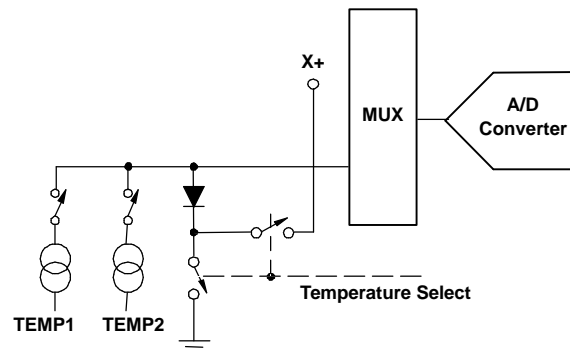

Figure 61. Functional Block Diagram of Temperature Measurement Mode.

$$^{\circ}\text{K} = \frac{q \Delta V}{k \ln(N)} \quad (6)$$

The second mode does not require a test temperature calibration, but uses a two-measurement (differential) method to eliminate the need for absolute temperature calibration, and achieves a 2°C/LSB accuracy. This mode requires a second conversion with a current 82 times larger than the first 20 μ A current. The voltage difference between the first (TEMP1) and second (Temp2) conversion, using 82 times the bias current, is represented by $kT/q \ln(N)$, where N is the current ratio = 82, k = Boltzmann's constant (1.38054×10^{-23} electron volts/degree Kelvin), q = the electron charge (1.602189×10^{-19} C), and T = the temperature in degrees Kelvin. This method can provide much improved absolute temperature measurement without calibration, with resolution of 2°C/LSB. The resultant equation for solving for °K is:

where

$$\Delta V = V(I_{82}) - V(I_1)_{(\text{inmV})} \quad (7)$$

$$\therefore ^{\circ}\text{K} = 2.573 \Delta V^{\circ}\text{K/mV}$$

$$^{\circ}\text{C} = 2.573 \Delta V(\text{mV}) - 273^{\circ}\text{K} \quad (8)$$

Temperature 2 measurement is illustrated in Figure 63.

Temperature Input 1

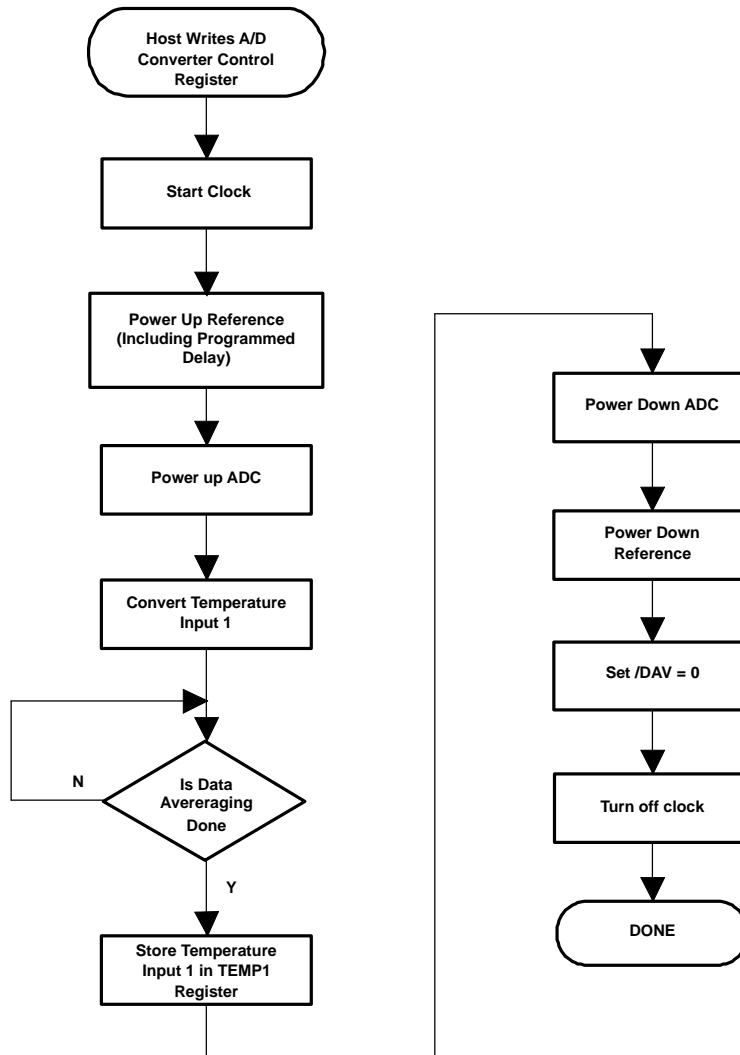

Figure 62. Single Temperature Measurement Mode

Temperature Input 2

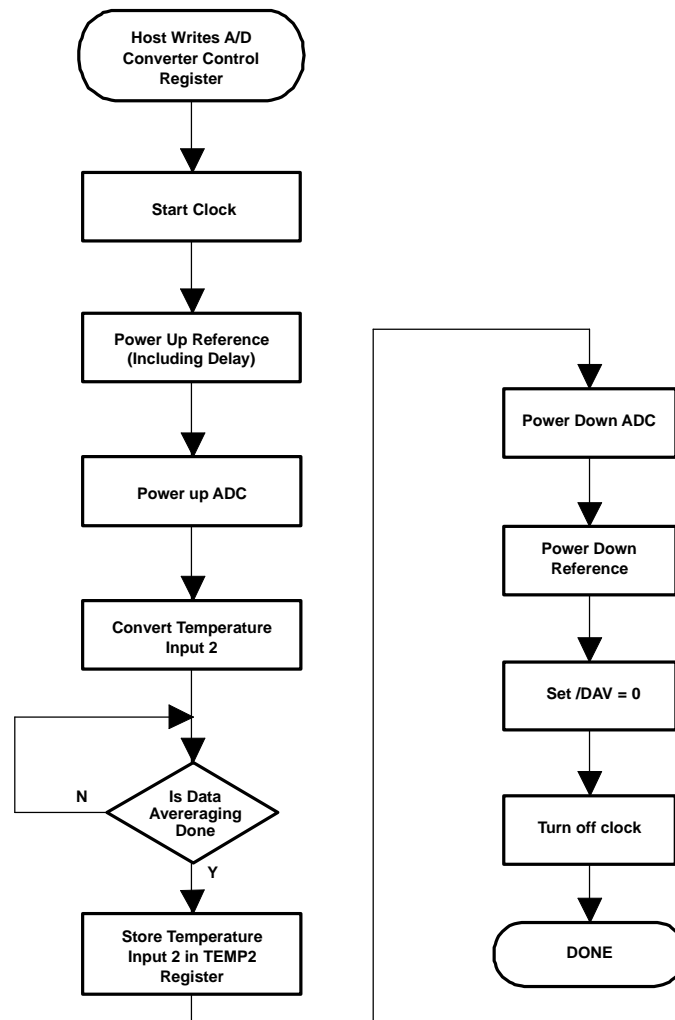

Figure 63. Additional Temperature Measurement for Differential Temperature Reading

OPERATION - BATTERY MEASUREMENT

An added feature of the TSC2300 is the ability to monitor the battery voltage which may be much larger than the supply voltage of the TSC2300. An example of this is shown in Figure 64, where a battery voltage ranging up to 6V may be regulated by a dc/dc converter or low-dropout regulator to provide a lower supply voltage to the TSC2300. The battery voltage can vary from 0.5 V to 6 V while maintaining the voltage to the TSC2300 at a level of 2.7 V-3.6 V. The input voltage on V_{BAT1} is divided down by 4 so that a 6.0V battery voltage is represented as 1.5 V to the A/D, while the input voltage on V_{BAT2} is divided by 2 so that 3.0-V battery voltage is represented as 1.5 V to the A/D. If the battery voltage is low enough, the 1.2 V internal reference can be used to decrease LSB size, potentially improving accuracy. The battery voltage on V_{BAT1} must be below $4 * V_{REF}$, and the voltage on V_{BAT2} must be below $2 * V_{REF}$. Due to constraints of the internal switches, the input to the A/D after the voltage divider cannot be above 1.5 V or V_{REF} , whichever is lower. In order to minimize the power consumption, the divider is only ON during the sampling of the battery input.

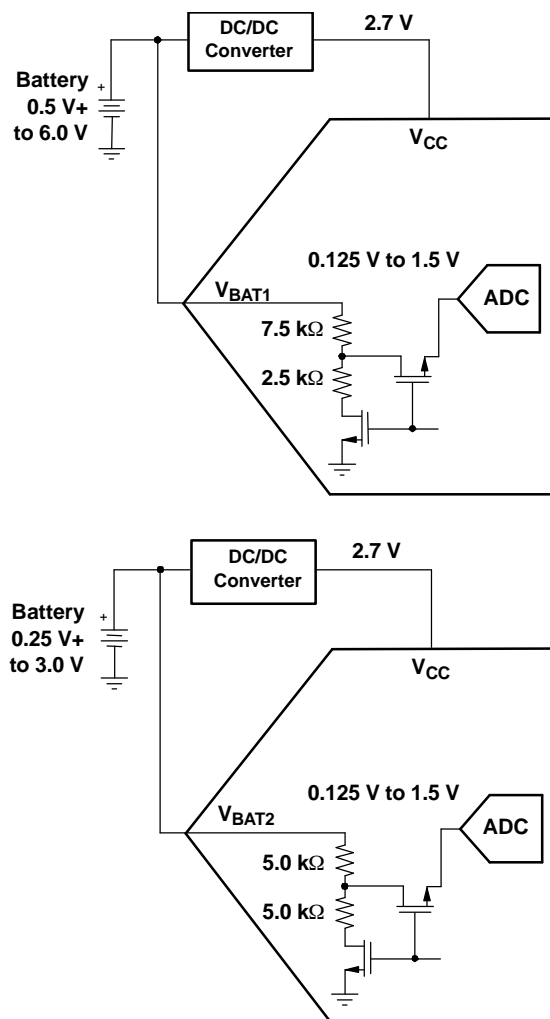

Figure 64. VBAT Example Battery Measurement Functional Block Diagrams, VDD = 2.7 V, V_{REF} = 2.5 V.

Flowcharts which detail the process of making a battery input reading are shown in Figure 65 and Figure 66.

The time needed to make temperature, auxiliary, or battery measurements is given by:

$$t_{\text{coordinate}} = 2.625 \mu\text{s} + t_{\text{REF}} + N_{\text{AVG}} \left(N_{\text{BITS}} \frac{1}{f_{\text{conv}}} + 4.4 \mu\text{s} \right) \quad (9)$$

where t_{REF} is the reference delay time as given in Table 15.

Battery Input 1

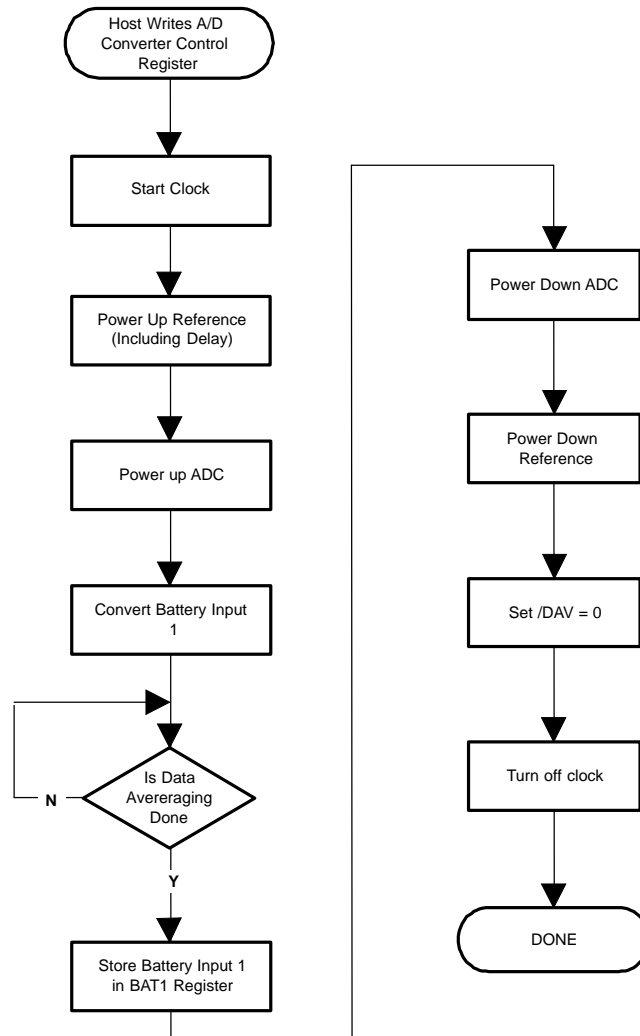

Figure 65. V_{BAT1} Measurement Process.

This assumes the reference control register is configured to power up the internal reference when needed.

Battery Input 2

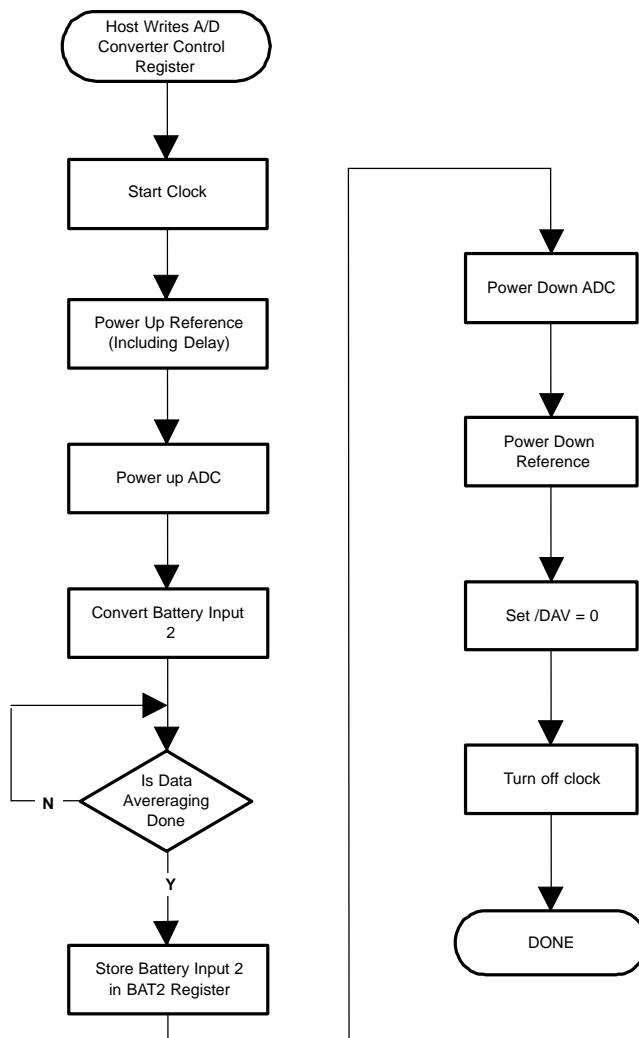

Figure 66. V_{BAT2} Measurement process.

OPERATION - AUXILIARY MEASUREMENT

The two auxiliary voltage inputs can be measured in similar fashion to the battery inputs, with no voltage dividers. The input range of the auxiliary inputs is 0 V to V_{REF} . Figure 67 and Figure 68 illustrate the process. Applications for this feature may include external temperature sensing, ambient light monitoring for controlling an LCD back-light, or sensing the current drawn from the battery.

Auxiliary Input 1

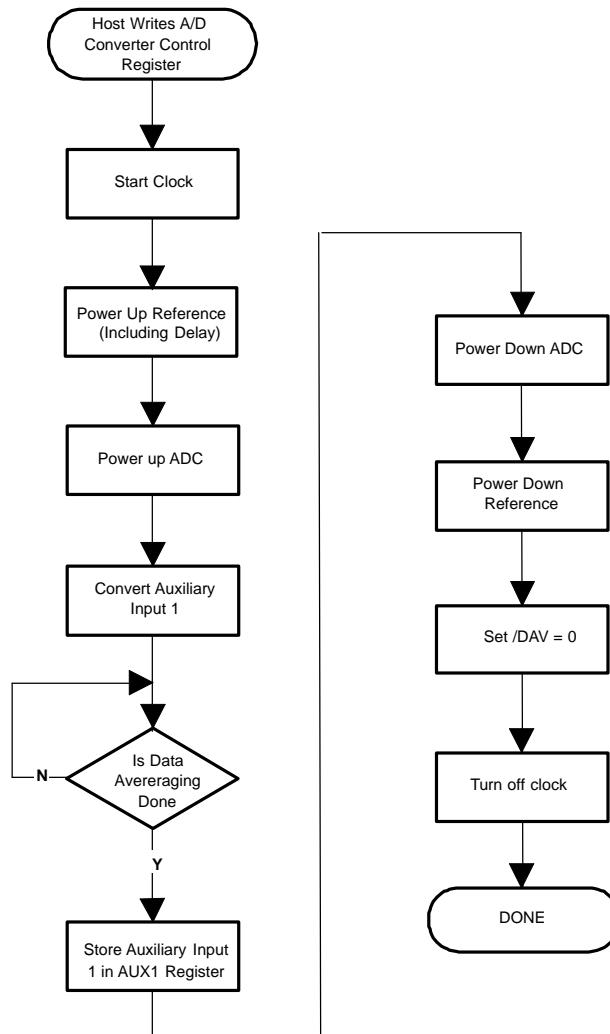

Figure 67. AUX1 Measurement Process

Auxiliary Input 2

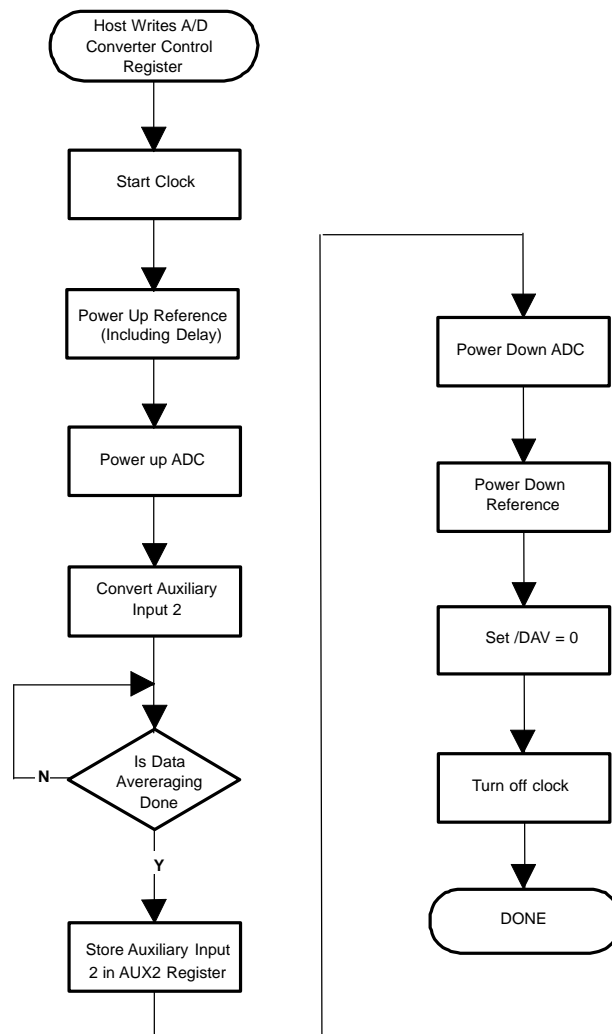

Figure 68. AUX2 Measurement Process

OPERATION - PORT SCAN

If measurements of all the battery and auxiliary inputs are required, the port scan mode can be used. This mode causes the TSC2300 to sample and convert both battery inputs and both auxiliary inputs. At the end of this cycle, the battery and auxiliary data registers contain the updated values, and the DAV pin is asserted low, signaling the host to read the data. Thus, with one write to the TSC2300, the host can cause four different measurements to be made. Because the battery and auxiliary data registers are consecutive in memory, all four registers can be read in one SPI transaction, as described in Figure 50.

The flowchart for this process is shown in Figure 69. The time needed to make a complete port scan is given by:

$$t_{\text{coordinate}} = 7.5 \mu\text{s} + t_{\text{REF}} + 4N_{\text{AVG}} \left(N_{\text{BITS}} \frac{1}{f_{\text{conv}}} + 4.4 \mu\text{s} \right) \quad (10)$$

Port Scan

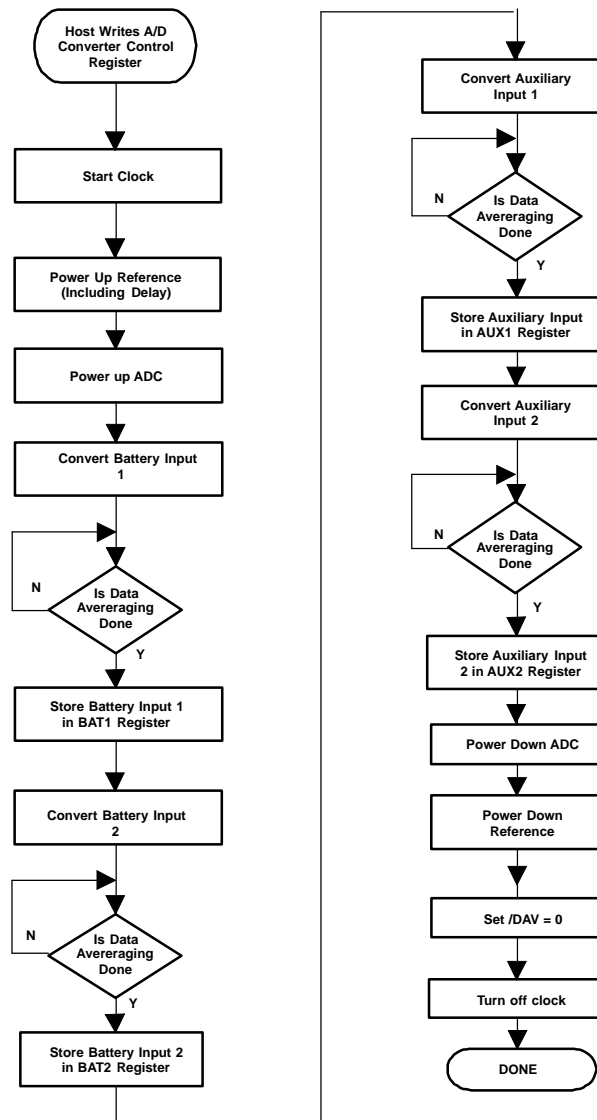

Figure 69. Port Scan Mode.

OPERATION-D/A CONVERTER

The TSC2300 has an onboard 8-bit D/A converter, configured as shown in Figure 70. This configuration yields a current sink (AOUT) controlled by the value of a resistor connected between the ARNG pin and ground. The D/A converter has a control register, which controls whether or not the converter is powered up. The eight-bit data is written to the D/A converter through the D/A converter data register.

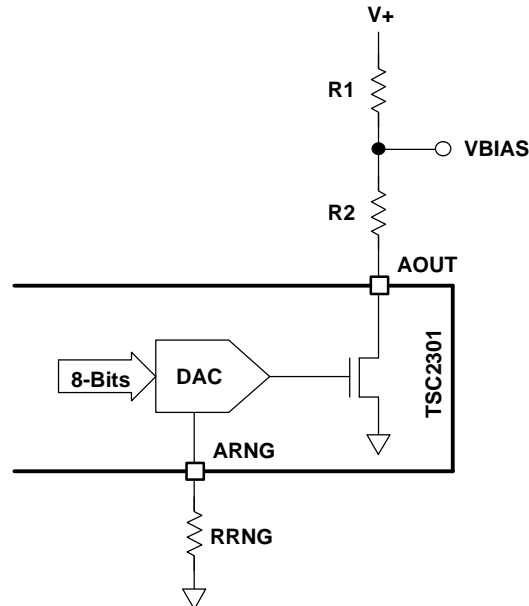

Figure 70. D/A Converter Configuration

This circuit is designed for flexibility in the output voltage at the VBIAS point shown in Figure 70 to accommodate the widely varying requirements for LCD contrast control bias. V+ can be a higher voltage than the supply voltage for the TSC2300. The only restriction is that the voltage on the AOUT pin can never go above the absolute maximum ratings for the device, and should stay above 1.5 V for linear operation.

The D/A converter has an output sink range which is limited to approximately 1 mA. This range can be adjusted by changing the value of RRNG shown in Figure 70. As this DAC is not designed to be a precision device, the actual value of the output current range can vary as much as $\pm 20\%$. Furthermore, the current output changes due to variations in temperature; the DAC has a temperature coefficient of approximately $0.9 \mu\text{A}/^\circ\text{C}$.

To set the full-scale current, RRNG can be determined from the graph shown in Figure 71.

**DAC FULLSCALE OUTPUT CURRENT
vs
RRNG RESISTOR VALUE**

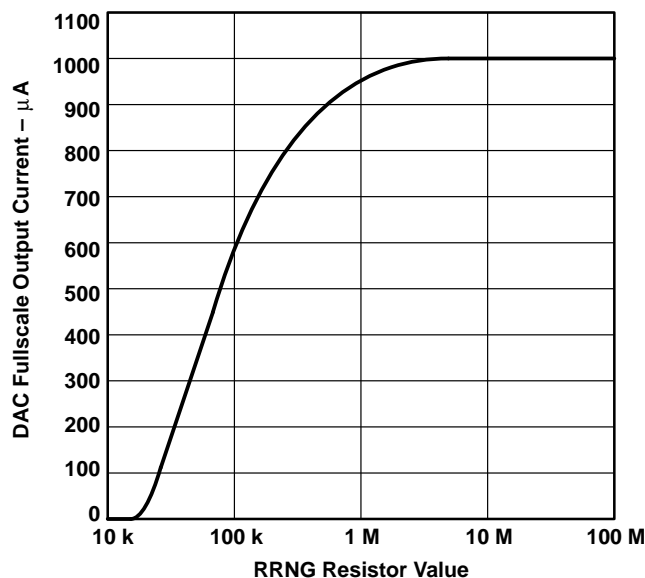

Figure 71. DAC Output Current Range vs RRNG Resistor Value.

For example, consider an LCD that has a contrast control voltage VBIAS that can range from 2 V to 4 V, that draws 400 μ A when used, and has an available 5-V supply. Note that this is higher than the TSC2300 supply voltage, but it is within the absolute maximum ratings.

The maximum VBIAS voltage is 4 V, and this occurs when the D/A converter current is 0, so only the 400- μ A load current ILOAD is flowing from 5 V to VBIAS. This means 1 V is dropped across R1, so $R1 = 1 \text{ V}/400 \mu\text{A} = 2.5 \text{ k}\Omega$.

The minimum VBIAS is 2 V, which occurs when the D/A converter current is at its full scale value, IMAX. In this case, 5 V - 2 V = 3 V is dropped across R1, so the current through R1 is 3 V/2.5 k Ω = 1.2 mA. This current is

$IMAX + ILOAD = IMAX + 400 \mu\text{A}$, so IMAX must be set to 800 μ A. Looking at Figure 73, this means that RRNG should be around 1 M Ω .

Since the voltage at the AOUT pin should not go below 1.5 V, this limits the voltage at the bottom of R2 to be 1.5-V minimum; this occurs when the D/A converter is providing its maximum current, IMAX. In this case, IMAX + ILOAD flows through R1, and IMAX flows through R2. Thus,

$$R2 \times IMAX + R1(IMAX + ILOAD) = 5 \text{ V} - 1.5 \text{ V} = 3.5 \text{ V} \quad (11)$$

With $R1 = 2.5 \text{ k}\Omega$, $IMAX = 800 \mu\text{A}$, $ILOAD = 400 \mu\text{A}$, thus allowing R2 to be solved as 625 Ω .

In the previous example, when the DAC current is zero, the voltage on the AOUT pin rises above the TSC2300 supply voltage. This is not a problem, however, since V+ was within the absolute maximum ratings of the TSC2300, so no special precautions are necessary. Many LCD displays require voltages much higher than the absolute maximum ratings of the TSC2300. In this case, the addition of an NPN transistor, as shown in Figure 72, protects the AOUT pin from damage.

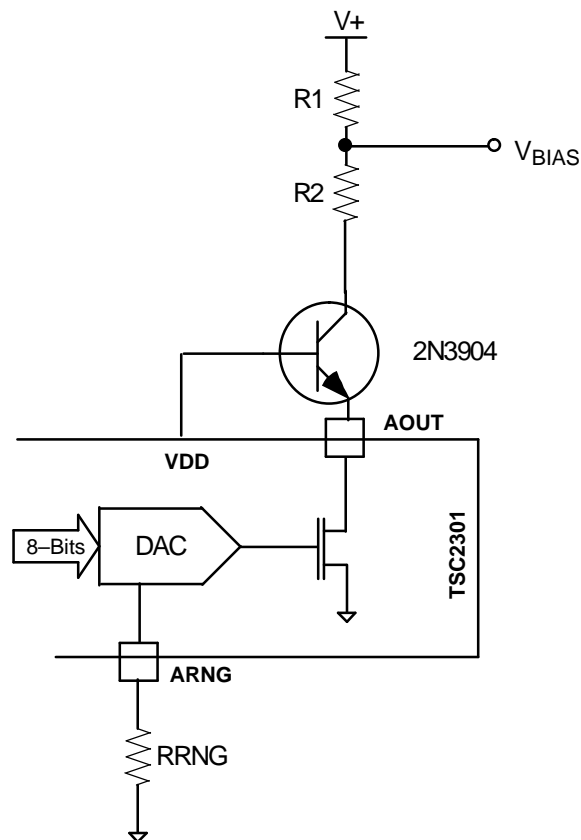

Figure 72. DAC Circuit When Using V+ Higher Than V_{supply}

OPERATION - KEYPAD INTERFACE

TSC2300

SLAS372 — NOVEMBER 2002

The TSC2300 contains a keypad interface which is suitable for use with matrix keypads up to 4 x 4 keys. A control register, the keypad control register, is used to set the scan rate for the keypad and de-bounce times. There is also a keypad mask register which allows certain keys to be masked from being read, or from causing the TSC2300 to detect a key-press on selected keys. The results of keypad scans are placed in the keypad data register.

When a key-press is detected by the TSC2300, it automatically scans the keypad and de-bounces the key-press. It then drives KBIRQ low. All keys pressed at the time of the scan are then reflected in the keypad data register. This mode is shown in Figure 73.

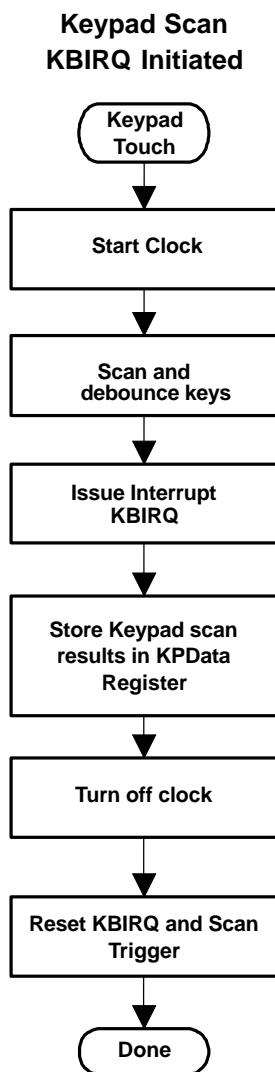

Figure 73. Keypad Scan Initiated by Keypress.

AUDIO CODEC

Audio Analog I/O

The TSC2300 has one pair of stereo inputs, LLINEIN and RLINEIN, and one mono audio input, MICIN. The part also has one pair of stereo line outputs capable of driving a 10-k Ω load, VOUTL and VOUTR, as well as a stereo headphone output amplifier capable of driving a 16- Ω load at up to 30 mW/channel, HPL HPR. Finally, the part includes a differential mono output capable of driving a 10-k Ω load per side, MONO+ and MONO-.

A special circuit has also been included for inserting a keyclick sound into the analog output signal path based on register control. This functionality is intended for generating keyclick sounds for user feedback. This function is controlled by Reg 04h, Pg 2, and is available when either of the DAC or analog bypass paths are enabled.

The common-mode voltage, VCM, used by the audio section can be powered up independently by the AVPD bit (Bit 14, Reg 05h, Pg 2). Because the audio outputs are biased to this voltage, this voltage is slowly ramped up when powered on, and there is an internally programmed delay of approximately 500 msec between powering up this voltage and unmuting the analog audio signals of the TSC2300, in order to avoid pops and clicks on the outputs. It is recommended to keep VCM powered up if the 500-msec delay is not tolerable.

Audio Digital I/O

Digital audio data samples can be transmitted between the TSC2300 and the CPU via the I²S bus (BCLK, LRCLK, I2SDIN, I2SDOUT). However, all registers, including those pertaining to audio functionality, are only accessible via the SPI bus. The I²S bus operates only in slave mode, meaning the BCLK and LRCLK must be provided as inputs to the part. Four programmable modes for this serial bus are supported and can be set through the I2SFM bits (Bits[1:0], Reg 00h, Pg 2) .

PCM Audio Interface

The 4-wire digital audio interface for TSC2300 is comprised of BCLK (pin 24), LRCLK (pin 25), I2SDIN (pin 26), and I2SDOUT (pin 27). For the TSC2300, these formats are selected through the I2SFM bits in Reg 00h, Pg 2. The following figures illustrate audio data input/output formats and timing.

The TSC2300 can accept 32-, 48- or 64-bit clocks (BCKIN) in one clock of LRCIN. Only 16-bit data formats can be selected when 32-bit clocks/LRCIN are applied.

TSC2300

SLAS372 — NOVEMBER 2002

FORMAT 0

DAC: 16-Bit, MSB-First, Right-Justified

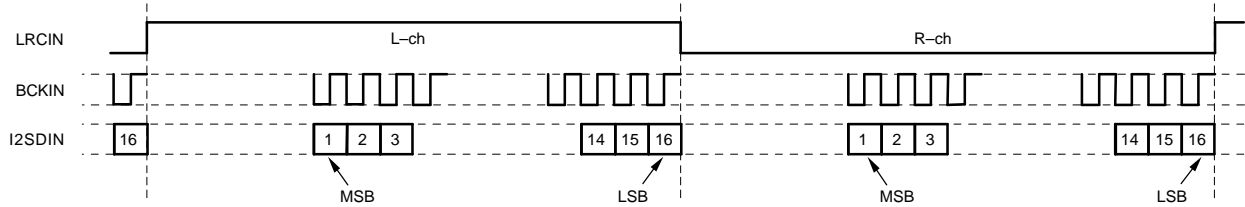

ADC: 16-Bit, MSB-First, Left-Justified

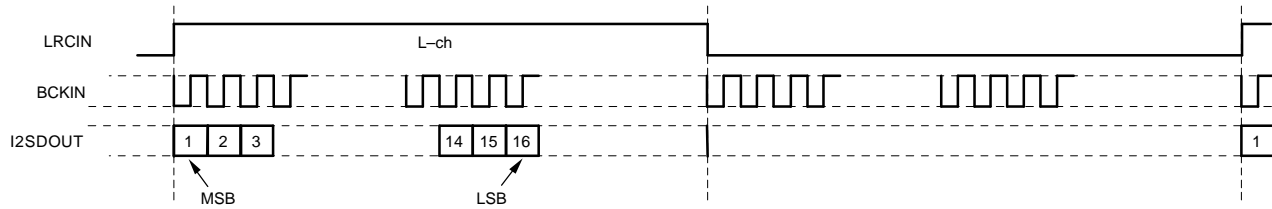

FORMAT 1

DAC: 20-Bit, MSB-First, Right-Justified

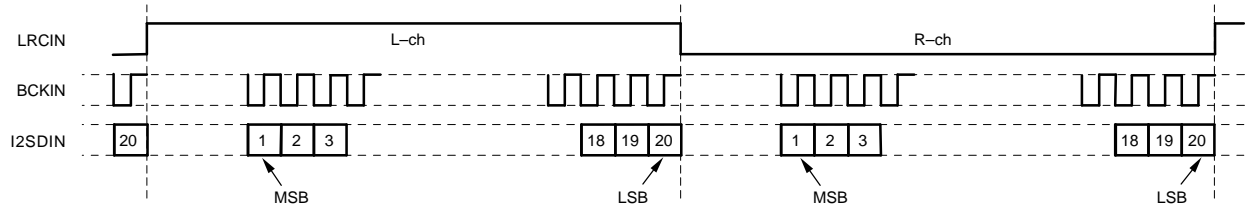

ADC: 20-Bit, MSB-First, Left-Justified

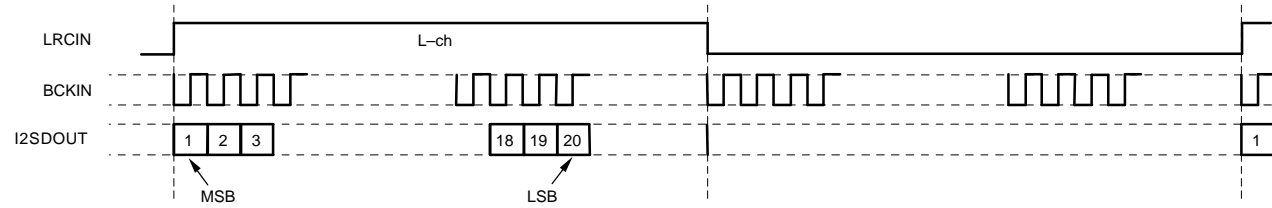

FORMAT 2

DAC: 20-Bit, MSB-First, Left-Justified

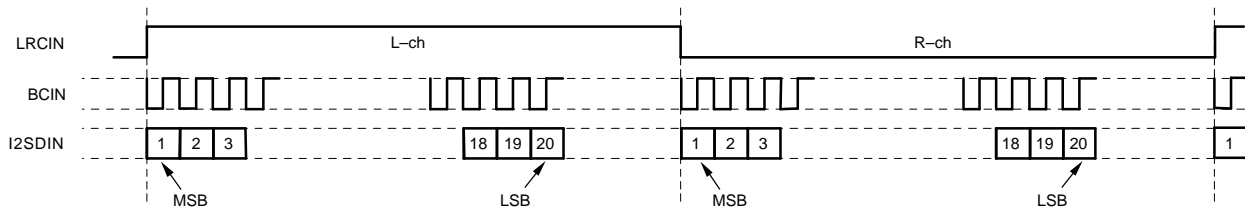

ADC: 20-Bit, MSB-First, Left-Justified

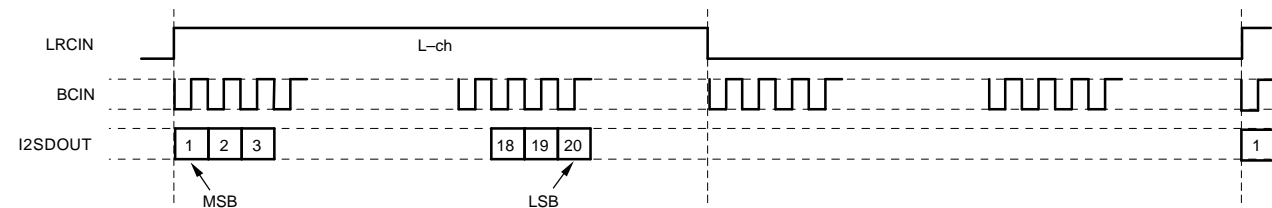
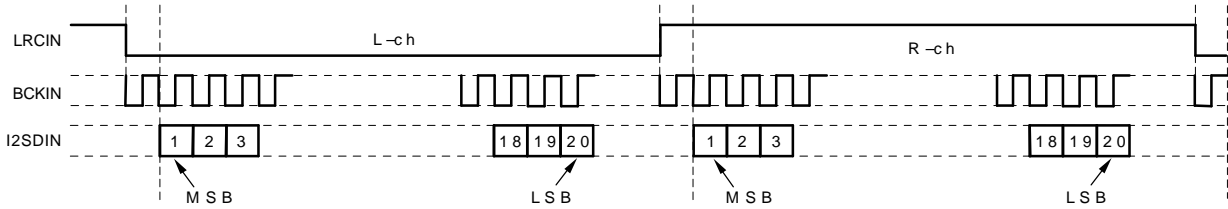

Figure 74. Audio Data Input/Output Format

FORMAT 3

DAC: 20-Bit, MSB-First, I²S



ADC: 20-Bit, MSB-First, I²S

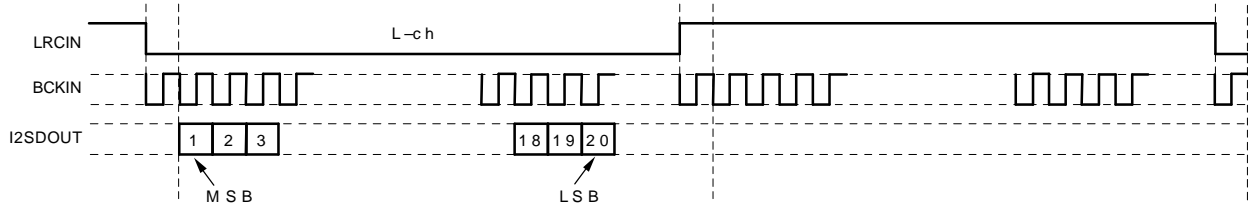

Figure 75. Audio Data Input/Output Format

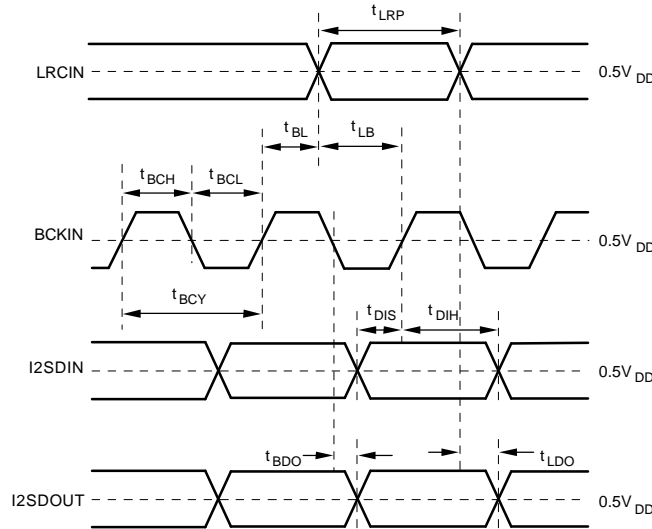

Figure 76. Audio Data Input/Output Timing

Table 26. Audio Data Input/Output Timing

Parameter	Symbol	Min	Max
BCKIN Pulse Cycle Time	t_{BCY}	300 nsmin	
BCKIN Pulse Width High	t_{BCH}	120 ns	
BCKIN Pulse Width Low	t_{BCL}	120 ns	
BCKIN Rising Edge to LRCIN Edge	t_{BL}	40 ns	
LRCIN Edge to BCKIN Rising Edge	t_{LB}	40 ns	
LRCIN Pulse Width	t_{LRP}	t_{BCY} ns	
I2SDIN Setup Time	t_{DIS}	40 ns	
I2SDIN Hold Time	t_{DIH}	40 ns	
I2SDOUT Delay Time to BCKIN Falling Edge	t_{BDO}		40 ns
I2SDOUT Delay Time to LRCIN Edge	t_{LDO}		40 ns
Rising Time to All Signals	t_{RISE}		20 ns
Falling Time to All Signals	t_{FALL}		20 ns

Audio Data Converters

The TSC2300 includes a stereo 20-bit audio DAC and a mono 20-bit audio ADC. The DAC and ADC are both capable of operating at 8 kHz, 11.025 kHz, 12 kHz, 16 kHz, 22.05 kHz, 24 kHz, 32 kHz, 44.1 kHz, or 48 kHz. The DAC and ADC must operate at the same sampling rate.

When the ADC or DAC is operating, the part requires an audio MCLK input, which should be synchronous to the I²S bus clock. The MCLK can be 256/384/512 times the I²S LRCLK rate. An internal PLL takes any of these possible input clocks and generates a digital clock for use by the internal circuitry of either 44.1 kHz x 512 = 22.5792 MHz (when 44.1 kHz submultiple sample-rates are selected) or 48 kHz x 512 = 24.576 MHz (when 48 kHz submultiple sample-rates are selected). The user is required to set the MCLK bits (Bits[7:6], Reg 00h, Pg 2) to tell the part the ratio between MCLK and the I²S LRCLK rate (there is no specific phase alignment requirement between MCLK and BCLK). The user is also required to set the I2SFS bits (Bits[5:2], Reg 00h, Pg 2) to tell the part what sample rate is in use. When the user is using either 44.1 kHz or 48-kHz sampling rates, and providing a 512 x Fs MCLK, the internal PLL is powered down, as MCLK can be used directly to clock the internal circuitry. This reduces power consumption.

If the user wishes to change sampling rates, the data converters (both DAC's and ADC) should be muted, then powered down. The LRCLK and BCLK rates should then be changed. Next the user should write the appropriate settings to the MCLK, I2SFS, and I2SFM bits, then power up the data converters. Finally, the data converters can be un-muted.

Due to the wide supply range over which this part must operate, the audio does not operate on an internal reference voltage. The common-mode voltage that the single-ended audio signals are referenced to is set by a divider between the analog supplies and is given by $0.4 \times AVDD$. The reference voltages used by the audio codec must be provided as inputs to the part at the Vref+/Vref- pins and are intended to be connected to the same voltage levels as AVDD and AGND, respectively. Because of this arrangement, the voltages applied to AVDD, AGND, Vref+, and Vref- should be kept as clean and noise-free as possible.

DAC Digital Volume Control

The DAC digital effects processing block implements a digital volume control that can be set through the SPI registers. The volume level can be varied from 0 dB to -63.5 dB in 0.5-dB steps independently for each channel. The user can mute each channel independently by setting the mute bits in the DAC volume control register (Reg 02h, Pg 2). There is a soft-stepping algorithm included in this block, which only changes the actual volume every 20 μ s, either up or down, until the desired volume is reached. This speed of soft-stepping can be slowed to once every 40 μ s through the SSRTE bit (Bit 1, Reg 04h, Pg 2).

Because of this soft-stepping, the host does not know whether the DAC has actually been fully muted or not. This may be important if the host wishes to mute the DAC before making a significant change, such as changing sample rates. In order to help with this situation, the part provides a flag back to the host via a read-only SPI register bit (Bit 0, Reg 04h, Pg 2) that alerts the host when the part has completed the soft-stepping, and the actual volume has reached the desired volume level.

The part also includes functionality to detect when the user switches on or off the de-emphasis or bass-boost functions, and to first soft-mute the DAC volume control, then change the operation of the digital effects processing, then soft-unmute the part. This avoids any possible pop/clicks in the audio output due to instantaneous changes in the filtering. A similar algorithm is used when first powering up or down the DAC/ADC. The circuit begins operation at power-up with the volume control muted, then soft-steps it up to the desired volume level slowly. At power-down, the logic first soft-steps the volume down to a mute level, then powers down the circuitry.

Stereo DAC Overview

The stereo DAC consists of a digital block to implement digital interpolation filter, volume control, de-emphasis filter and programmable digital effects/bass-boost filter for each channel. These are followed by a 5th-order single-bit digital delta-sigma modulator, and switched capacitor analog reconstruction filter. The DAC has been designed to provide enhanced performance at low sample rates through increased oversampling and image filtering, thereby keeping quantization noise generated within the delta-sigma modulator and signal images strongly suppressed in the full audio band of 20 Hz-20 kHz, even at low sample rates such as 8 kHz. This is realized by keeping the upsampled rate approximately constant and changing the oversampling ratio as the input sample rate is reduced. For rates of 8/12/16/24/32/48 kHz, the digital delta-sigma modulator always operates at a rate of 6.144 MHz, giving oversampling ratios of 768/512/384/256/192/128, respectively. This ensures that quantization noise generated within the delta-sigma modulator stays low within the frequency band below 20 kHz at all sample rates. Similarly, for rates of 11.025/22.05/44.1 kHz, the digital delta-sigma modulator always operates at a rate of 5.6448 MHz, yielding oversampling ratios of 512/256/128, respectively.

Conventional audio DAC designs utilize high-order analog filtering to remove quantization noise that falls within the audio band when operating at low sample rates. Here, however, the increased oversampling at low sample rates keeps the noise above 20 kHz, yielding a similar noise floor out to 20 kHz whether the sample rate is 8 kHz or 48 kHz. If the audio bypass path is not in use when the stereo DAC is in use, the user should power down the bypass path, as this improves DAC SNR and reduces power consumption.

In addition, the digital interpolation filter provides enhanced image filtering to reduce signal images caused by the upsampling process that land below 20 kHz. For example, upsampling an 8-kHz signal produces signal images at multiples of 8 kHz, i.e., 8 kHz, 16 kHz, 24 kHz, etc. The images at 8 kHz and 16 kHz are below 20 kHz and thus are still audible to the listener, therefore they must be filtered heavily to maintain a good quality output. The interpolation filter is designed to maintain at least 65-dB rejection of signal images landing between 0.55 Fs and 3.5 Fs, for all sample rates, including any images that land within the audio band (20 Hz-20 kHz). Passband ripple for all sample-rate cases (from 20 Hz to 0.4535 Fs) is +/-0.1-dB maximum.

The analog reconstruction filter design consists of a switched-capacitor filter with one pole and three zeros. The single-bit data operates at 128 x 48 kHz = 6.144 MHz (for selected sample-rates that are submultiples of 48 kHz) or at 128 x 44.1 kHz = 5.6448 MHz (for selected sample-rates that are submultiples of 44.1 kHz). The interpolation filter takes data at the selected sample-rate from the effects processing block, then performs upsampling and image filtering, yielding a 6.144-MHz or 5.6448-MHz data stream, which is provided to the digital delta-sigma modulator.

Audio DAC SNR performance is 98-dB-A typical over 20 Hz - 20 kHz bandwidth in 44.1/48-kHz mode at the line-outputs with a 3.3-V supply level.

DAC Digital De-emphasis

The DAC digital effects processing block can perform several operations on the audio data before it is passed to the interpolation filter. One such operation is a digital de-emphasis, which can be enabled or disabled by the user via the DEEMP bit (Bit 0, Reg 05h, Pg 2). This is only available for sample rates of 32 kHz, 44.1 kHz, and 48 kHz. The transfer function consists of a pole with time constant of 50 µsec and a zero with time constant of 15 µsec.

DAC Programmable Digital Effects Filter

The DAC digital effects processing block also includes a fourth order digital IIR filter with programmable coefficients (independently programmable per channel). The filter transfer function is given by:

$$\left(\frac{N_0 + 2 N_1 Z^{-1} + N_2 Z^{-2}}{32768 - 2 D_1 Z^{-1} - D_2 Z^{-2}} \right) \left(\frac{N_3 + 2 N_4 Z^{-1} + N_5 Z^{-2}}{32768 - 2 D_4 Z^{-1} - D_5 Z^{-2}} \right) \quad (12)$$

The N and D coefficients are set via SPI registers, and this filter can be enabled or disabled via the BASS bit (Bit 1, Reg 05h, Pg 2). This functionality can implement a number of different functions, such as bass-boost (default), treble-boost, mid-boost, or other equalization. This transfer function(s) can be determined by the user and loaded to the TSC2300 at power-up, and the feature can then be switched on or off by the user during normal operation.

The default coefficients at reset are given by:

N0=N3=27618	D1=D4=32130
N1=N4=-27033	D2=D5=-31505
N2=N5=26461	

which implements the bass-boost transfer function shown in Figure 77, having a 3-dB attenuation for signals above approximately 150 Hz when operating at a 48-kHz sampling rate. All coefficients are represented by 16-bit twos complement integers with values ranging from -32768 to +32767.

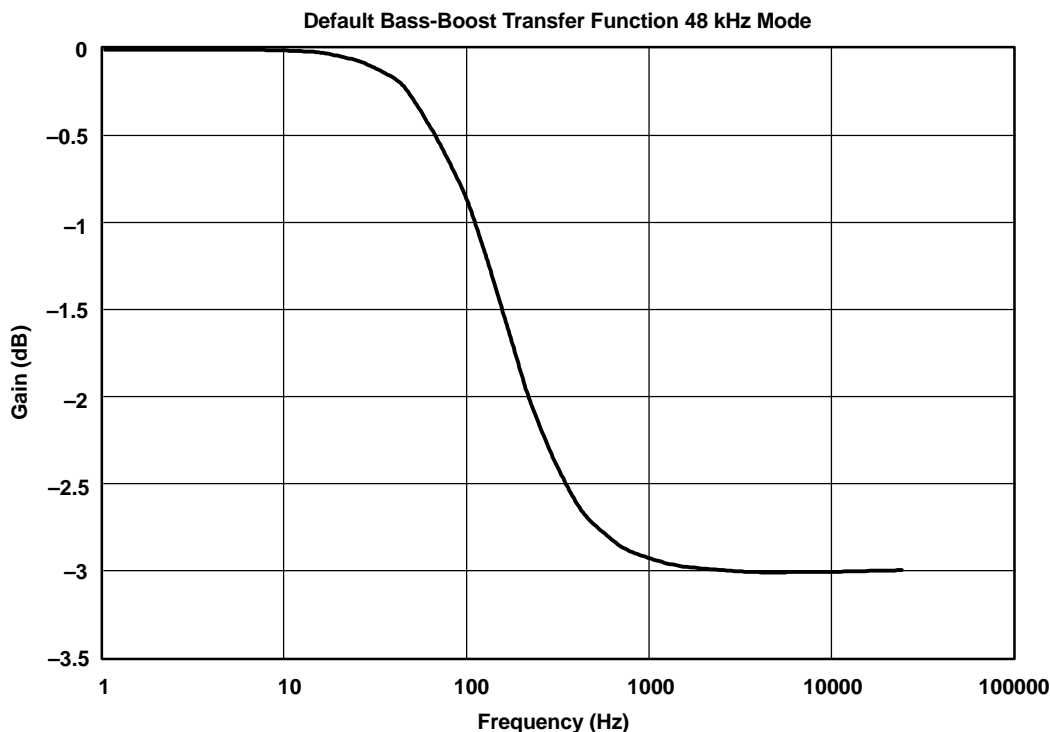

Figure 77. Transfer Function of Default Bass-Boost Filter Coefficients at 48-kHz Sampling Rate.

Audio ADC

The audio ADC consists of a 4th order multi-bit analog delta-sigma modulator, followed by a digital decimation filter. The digital output data is then passed to the bus interface for transmission back to the CPU.

The analog modulator is a fully differential switched-capacitor design with multi-bit quantizer and dynamic element matching to avoid mismatch errors. The modulator operates at an oversampling ratio of 128 for all sample rates. The input to the ADC is filtered by a single-pole analog filter with -3-dB point at approximately 500 kHz for antialiasing. This analog filter uses a single off-chip 1 nF cap per ADC (at the AFILT pins) and on-chip resistor.

The digital decimation filter block includes a high-pass IIR filter for the purpose of removing any dc or sub-audio-frequency component from the signal. Since such a low frequency filter can have significant settling time, the filter has an adjustable cutoff frequency, in order to allow the host to set a faster settling time initially, then later switch it back to a level that does not affect the audio band. The settings for this high-pass filter are:

HPF -3-dB frequency:	0.000019 Fs (0.912 Hz at Fs=48 kHz)
	0.000078 Fs (3.744 Hz at Fs=48 kHz)
	0.1 Fs (4.8 kHz at Fs=48 kHz)

The filter block provides an audio passband ripple of +/-0.03 dB over a passband from 0 Hz to 0.454 Fs, and 70-dB minimum stopband attenuation from 0.548 Fs to 64 Fs.

The ADC modulator and digital filter operate on a clock that changes directly with sampling frequency (Fs). This is in contrast to the DAC, which keeps the modulator running at a high rate of 128 x 44.1 kHz or 128 x 48 kHz even if the incoming data rate is much lower, such as 8 kHz. Group delay of the ADC path varies with sampling frequency and is given by 28.7/Fs.

Audio ADC SNR performance is 88-dB-A typical over 20-Hz - 20-kHz bandwidth in 44.1/48-kHz mode with a 3.3-V supply level.

The audio ADC is preceded by an analog volume control with gain programmable from 20 dB to -40 dB or mute in 0.5-dB steps using Reg 01h, Pg 2. The input to the volume control is selected as LLINEIN, RLINEIN, MICIN, or a mono mix of LLINEIN and RLINEIN through the INM bits (Bits [13:12], Reg 00h, Pg 2). An additional preamp gain is selectable on the MICIN input as 0 dB, 6 dB, or 12 dB using the MICG bits (Bits [9:8], Reg 00h, Pg 2).

Audio Bypass Mode

In audio bypass mode, the L/RLINEIN analog inputs can be routed to mix with the DAC output and play to the line-outputs (VOU_{TL}/R) as well as the headphone outputs (HPL/R) and mono output (MONO+/-). This path has a stereo analog volume control associated with it, with range settings from +12.0 dB to -35.5 dB in 0.5-dB steps. If the audio ADC's and DAC's are not used while the bypass path is in use, the ADC's and DAC should be powered down to improve noise performance and reduce power consumption.

This analog volume control has soft-stepping logic associated with it, so that when a volume change is made via the SPI bus, the logic changes the actual volume incrementally, single-stepping the actual volume up or down once every 20 µsec until it reaches the desired volume level.

This volume control also has similar algorithms as the ADC/DAC volume controls, in that the volume starts at mute upon power-up, then is slowly single-stepped up to the desired level. At a power-down request, the volume is slowly single-stepped down to mute before the circuit is actually powered down.

Differential Monophonic Output (MONO+/-)

The differential mono output of the TSC2300 can be used to drive a power amplifier which drives a low-impedance speaker. This block can output either a mono mix of the stereo line outputs, or the analog input to the audio ADC. This is selected through the MONS bit (Bit 2, Reg 04h, Pg 2). The mono mix of the line outputs is represented by the equation $V_{OUTL/2} + V_{OUTR/2}$. Similarly, the mono mix of the analog line inputs is represented by $LLINEIN/2 + RLINEIN/2$.

Microphone Bias Voltage (MICBIAS)

The TSC2300 provides an output voltage suitable for biasing an electret microphone capsule. This voltage is always 1 V below the supply voltage of the part. This output can be disabled through the MIBPD bit (Bit 6, Reg 05h, Pg 2) to reduce power consumption if not used.

Power Consumption

The TSC2300 provides maximum flexibility to the user for control of power consumption. Towards that end, every section of the TSC2300 audio codec can be independently powered down. The power down status of the different sections is controlled by Reg 05h in Pg 2. The analog bypass path, headphone amplifier, mono output, stereo DAC, audio ADC, microphone bias, crystal oscillator, and oscillator clock buffer sections can all be powered down independently. It is recommended that the end-user power down all unused sections whenever possible in order to minimize power consumption. Below is a table showing power consumption in different modes of operation.

OPERATING MODE DESCRIPTION	REGISTER 05H BIT VALUES											POWER CONSUMPTION	
	15	14	13	12	11	10	9	8	6	5	4	TYP	UNITS
STEREO RECORD AND PLAYBACK													
Mono record, line playback, 48 kHz	0	0	1	1	1	0	0	1	1	0	0	TBD	mA
Mono record, line playback, 8 kHz	0	0	1	1	1	0	0	1	1	0	0	TBD	mA
Mono record, headphone playback, 48 kHz	0	0	1	0	1	0	0	1	1	0	0	TBD	mA
Mono record, headphone playback, 8 kHz	0	0	1	0	1	0	0	1	1	0	0	TBD	mA
STEREO PLAYBACK ONLY													
Line playback only, 48 kHz	0	0	1	1	1	0	1	1	1	0	0	TBD	mA
Headphone playback only, 48 kHz	0	0	1	0	1	0	1	1	1	0	0	TBD	mA
RECORD ONLY													
Mono record, 48 kHz	0	0	1	1	1	1	0	1	1	0	0	TBD	mA
Mono record only, 8 kHz	0	0	1	1	1	1	0	1	1	0	0	TBD	mA
ANALOG BYPASS													
Line in to line out	0	0	0	1	1	1	1	1	1	0	0	TBD	mA
Line in to headphone out	0	0	0	0	1	1	1	1	1	0	0	TBD	mA
POWER DOWN													
Power down all	1	1	X	X	X	X	X	X	X	0	0	TBD	mA
Power down, VCM enabled	1	0	X	X	X	X	X	X	X	0	0	0.8	µA

TSC2300

SLAS372 — NOVEMBER 2002

TSC2300 AUDIO CONTROL REGISTERS

TSC2300 Audio Control Register (Page 2, Address 00H)

The audio control register of the TSC2300 controls the digital audio interface, the microphone preamp gain, the record multiplexer settings, and the ADC highpass filter pole. This register determines which ADC high pass filter response is selected, as well as which audio inputs are connected to the stereo ADC's. The gain of the MIC input (0 to +12 dB) is also selected. This register is also used to tell the data converters the frequency of MCLK, along with the frequency of LRCLK (ADC and DAC sample rates). The format of the audio data is also selected.

The audio control register is formatted as follows:

BIT 15 MSB	BIT 14	BIT 13	BIT 12	BIT 11	BIT 10	BIT 9	BIT 8	BIT 7	BIT 6	BIT 5	BIT 4	BIT 3	BIT 2	BIT 1	BIT 0 LSB
HPF1	HPF0	INM1	INM0	RESV	RESV	MICG 1	MICG 0	MCLK 1	MCLK 0	I2SFS 3	I2SFS 2	I2SFS 1	I2SFS 0	I2SF1	I2SF0

Bits [15:14] HPF1-HPF0

ADC High Pass Filter. These two bits select the pass-band for the high-pass filter or disable the filter. The default state of the filter is enabled, with -3-dB frequency at $0.000019x Fs$.

Table 27. High-Pass Filter Operation

HPF[1:0]		
HPF1	HPF0	DESCRIPTION
0	0	HPF Disabled, signal passes through unaltered
0	1	HPF -3-dB frequency= $0.1x Fs$
1	0	HPF -3-dB frequency= $0.000078x Fs$
1	1	HPF -3-dB frequency= $0.000019x Fs$ (default)

Bits [13:12] INM1-INM0

Audio ADC Input Multiplexer. These two bits select the analog input for the audio ADC. The input to the ADC can come from the microphone input, right line input, left line input, or from a mono mix of the left and right line inputs. The default input to the audio ADC is the microphone input.

Table 28. Audio ADC Input Selection

INM[1:0]		
INM1	INM0	DESCRIPTION
0	0	ADC input=MIC (default)
0	1	ADC input=LLINEIN
1	0	ADC input=RLINEIN
1	1	ADC input=(RLINEIN+LLINEIN)/2

Bits [11:10] Reserved

Bits [9:8] MICG1-MICG0

Microphone Preamp Gain. These two bits select the gain of the microphone input channel. The gain of the microphone input channel can be 0 dB, +6 dB, or +12 dB. The default gain of the microphone input channel is 0 dB.

Table 29. Microphone Input Gain Selection

Microphone Input Gain Selection (continued)

MICG[1:0]		
MICG1	MICG0	DESCRIPTION
0	0	MIC gain=0 dB (default)
0	1	MIC gain=0 dB
1	0	MIC gain=6 dB
1	1	MIC gain=12 dB

Bits [7:6] MCLK1-MCLK0

Master Clock Ratio. These two bits select the ratio of the audio master clock frequency to the audio sampling frequency. The ratio can be 256 Fs, 384 Fs, or 512 Fs. The default master clock frequency is 256 Fs.

Table 30. Master Clock Ratio Selection

MCLK[1:0]		
MCLK1	MCLK0	DESCRIPTION
0	0	Master clock (MCLK)=256 x Fs (default)
0	1	Master clock (MCLK)=384 x Fs
1	0	Master clock (MCLK)=512 x Fs
1	1	Master clock (MCLK)=256 x Fs

Bits [5:2] I2SFS3-I2SFS0

I²S Sample Rate. These bits tell the internal PLL what the audio sampling rate is so that it provides the proper clock rate to the data converters and the digital filters. The default sample rate is 48 kHz. See Table 31 for a complete listing of available sampling rates. All combinations of I2SFS[3:0] not in Table 31 are not valid.

Table 31. I²S Sample Rate Select

I2SFS3	I2SFS2	I2SFS1	I2SFS0	FUNCTION
0	0	0	0	Fs=48 kHz (default)
0	0	0	1	Fs=44.1 kHz
0	0	1	0	Fs=32 kHz
0	0	1	1	Fs=24 kHz
0	1	0	0	Fs=22.05 kHz
0	1	0	1	Fs=16 kHz
0	1	1	0	Fs=12 kHz
0	1	1	1	Fs=11.05 kHz
1	0	0	0	Fs=8 kHz

Bits [1:0] I2SFM1-I2SFM0

I²S Format. These two bits select the I²S interface format. Both 16-bit and 20-bit data formats are supported. The default format is 20-bit I²S.

Table 32. I²S Format Selection

I2SFM [1:0]		
I2SFM1	I2SFM0	DESCRIPTION
0	0	DAC: 16-bit, MSB-first, right justified ADC: 16-bit, MSB-first, left justified
0	1	DAC: 20-bit, MSB-first, right justified ADC: 20-bit, MSB-first, left justified
1	0	DAC: 20-bit, MSB-first, left justified ADC: 20-bit, MSB-first, left justified

TSC2300

SLAS372 — NOVEMBER 2002

I²S Format Selection (continued)

I2SFM [1:0]		
I2SFM1	I2SFM0	DESCRIPTION
1	1	DAC: 20-bit, MSB-first, I ² S (default) ADC: 20-bit, MSB-first, I ² S (default)

ADC VOLUME CONTROL REGISTER (Page 2, Address 01h)

The ADC volume control register controls the programmable gain amplifier (PGA) on the input to the audio ADC of the TSC2300. The gain of this PGA can be adjusted from

-40 dB to +20 dB in 0.5-dB steps. The ADC input can also be hard-muted, or internally shorted to VCM so that no input signal is seen.

The ADC volume control register is formatted as follows:

BIT 15 MSB	BIT 14	BIT 13	BIT 12	BIT 11	BIT 10	BIT 9	BIT 8	BIT 7	BIT 6	BIT 5	BIT 4	BIT 3	BIT 2	BIT 1	BIT 0 LSB
ADMU	ADV6	ADV5	ADV4	ADV3	ADV2	ADV1	ADV0	RESV	RESV	RESV	RESV	RESV	RESV	RESV	RESV

Bit 15 ADMU

ADC Mute. This bit is used to mute the input to the ADC volume control. The user can set this bit to mute the ADC while retaining the previous gain setting in ADV[6:0], so that the PGA returns to the previous gain setting when ADMU is cleared. When the ADMU bit is set, the ADC PGA soft-steps down to its lowest level, then mutes. This procedure is used to reduce any audible artifacts (pops or clicks) during the mute operation. This soft-stepping process is reversed when the ADMU bit is cleared (unmute).

Table 33. ADC Mute

ADMU	DESCRIPTION
0	ADC is active.
1	Audio ADC is mute. (default)

Bits [14:8] ADV6- ADV0

Audio ADC Volume Control. These 7 bits control the gain setting of the audio ADC volume control. This volume control can be programmed from -40 dB to +20 dB in 0.5-dB steps. Full volume (+20 dB) corresponds to a setting of 7Fh. Unity gain (0 dB) corresponds to 57h. Full attenuation (-40 dB) corresponds to 07h. Any value lower than 07h engages the mute function described above. Volume control changes are always soft-stepped, as described above. The default volume setting is 0 dB.

ADV[6:0] = 1010111 (087d) = 0 dB (default)

ADV[6:0] = 1111111 (127d) = +20 dB (Max)

ADV[6:0] = 0000111 (007d) = -40 dB (Min)

ADV[6:0] = 0d-6d = mute

Bits [7:0] Reserved

DAC VOLUME CONTROL REGISTER (Page 02, Address 02h)

The DAC volume control register controls the independent digital gain controls on the left and right channel audio DAC's of the TSC2300. The gain of the DAC's can be adjusted from -63.5 dB to 0 dB in 0.5-dB steps. The DAC inputs can also be muted, so that all zeroes are sent to the DAC interpolation filters.

The DAC volume control register is formatted as follows:

BIT 15 MSB	BIT 14	BIT 13	BIT 12	BIT 11	BIT 10	BIT 9	BIT 8	BIT 7	BIT 6	BIT 5	BIT 4	BIT 3	BIT 2	BIT 1	BIT 0 LSB
DAMUL	DAVL6	DAVL5	DAVL4	DAVL3	DAVL2	DAVL1	DAVL0	DAMUR	DAVR6	DAVR5	DAVR4	DAVR3	DAVR2	DAVR1	DAVR0

Bit 15 DAMUL

Left DAC Mute. This bit is used to mute the input to the Left Channel DAC. The user can set this bit to mute the DAC while retaining the previous gain setting in DAVL[6:0], so that the gain control returns to the previous gain setting when DAMUL is cleared. When the DAMUL bit is set, the left DAC digital gain control soft-steps down to its lowest level, then all zeroes are sent to the interpolation filter of this DAC. This procedure is used to reduce any audible artifacts (pops or clicks) of the mute procedure. This soft-stepping process is reversed when the DAMUL bit is cleared (unmute).

Table 34. Left DAC Mute

DAMUL	DESCRIPTION
0	Left channel DAC is active.
1	Left channel DAC is mute. (default)

Bits [14:8] DAVL6- DAVL0

Left DAC Volume Control. These 7 bits control the gain setting of the left channel DAC volume control PGA. This volume control can be programmed from -63.5 dB to 0dB in 0.5-dB steps. Full volume (0dB) corresponds to a setting of 7Fh. Full attenuation (-63.5 dB) corresponds to 00h. The default volume setting is 0 dB.

DAVL[6:0] = 1111111 (127d) = 0 dB (default)

DAVL[6:0] = 0000000 (000d) = -63.5 dB (Min)

1LSB = 0.5 dB

Bit 7 DAMUR

Right DAC Mute. This bit is used to mute the input to the right channel DAC. The user can set this bit to mute the DAC while retaining the previous gain setting in DAVR[6:0], so that the gain control returns to the previous gain setting when DAMUR is cleared. When the DAMUR bit is set, the left DAC digital gain control soft-steps down to its lowest level, then all zeroes are sent to the interpolation filter of this DAC. This procedure is used to reduce any audible artifacts (pops or clicks) of the mute procedure. This soft-stepping process is reversed when the DAMUR bit is cleared (unmute).

Table 35. Right DAC Mute

DAMUR	DESCRIPTION
0	Right channel DAC is active.
1	Right channel DAC is mute. (default)

Bits [6:0] DAVR6- DAVR0

Right DAC Volume Control. These 7 bits control the gain setting of the right channel DAC volume control. This volume control can be programmed from -63.5 dB to 0 dB in 0.5-dB steps. Full volume (0dB) corresponds to a setting of 7Fh. Full attenuation (-63.5 dB) corresponds to 00h. The default volume setting is 0 dB.

DAVR[6:0] = 1111111 (127d) = 0 dB (default)

DAVR[6:0] = 0000000 (000d) = -63.5 dB (Min)

1LSB = 0.5 dB

ANALOG AUDIO BYPASS PATH VOLUME CONTROL REGISTER (Page 02, Address 03h)

The bypass path volume control register controls the independent programmable gain amplifiers (PGA's) on the left and right channel analog audio bypass paths of the TSC2300. These bypass paths direct the line inputs directly to the line and headphone outputs entirely in the analog domain, with no A/D or D/A conversion. This feature can be used for playback of an external analog source, such as an FM stereo tuner through the TSC2300's headphone amplifier. The gain of these PGA's can be adjusted from -35.5 dB to +12 dB in 0.5 dB steps. The bypass paths can also be muted, so that no signal is transmitted.

The bypass path volume control register is formatted as follows:

TSC2300

SLAS372 — NOVEMBER 2002

BIT 15 MSB	BIT 14	BIT 13	BIT 12	BIT 11	BIT 10	BIT 9	BIT 8	BIT 7	BIT 6	BIT 5	BIT 4	BIT 3	BIT 2	BIT 1	BIT 0 LSB
BPMUL	BPVL6	BPVL5	BPVL4	BPVL3	BPVL2	BPVL1	BPVL0	BPMUR	BPVR6	BPVR5	BPVR4	BPVR3	BPVR2	BPVR1	BPVR0

Bit 15 BPMUL

Left Channel Audio Bypass Mute. This bit is used to mute the bypass path from the left channel line input (LLINEIN) to the left channel line and headphone outputs (VOUTL and HPL). The user can set this bit to mute the bypass path while retaining the previous gain setting in BPVL[6:0], so that the PGA returns to the previous gain setting when BPMUL is cleared. When the BPMUL bit is set, the PGA soft-steps down to its lowest level, then the bypass path is muted. This procedure is used to reduce any audible artifacts (pops or clicks) during the mute operation. This soft-stepping process is reversed when the BPMUL bit is cleared (unmute).

Table 36. Left Channel Audio Bypass Mute

BPMUL	DESCRIPTION
0	Left channel audio bypass path is active.
1	Left channel audio bypass path is mute. (default)

Bits [14:8] BPVL6- BPVL0

Left Channel Audio Bypass Path Volume Control. These 7 bits control the gain setting of the left channel bypass path volume control PGA. This volume control can be programmed from -35.5 dB to +12 dB in 0.5 dB steps. Full volume (+12 dB) corresponds to a setting of 7Fh. Unity gain (0 dB) corresponds to 67h. Full attenuation (-35.5 dB) corresponds to 20h. Any value lower than 20h engages the mute function described above. The default volume setting is 0 dB.

BPVL[6:0] = 1100111 (103d) = 0 dB (default)

BPVL[6:0] = 1111111 (127d) = +12 dB (Max)

BPVL[6:0] = 0100000 (032d) = -35.5 dB (Min)

BPVL[6:0] = 0d-31d = mute

Bit 7 BPMUR

Right Channel Audio Bypass Mute. This bit is used to mute the bypass path from the right channel line input (RLINEIN) to the right channel line and headphone outputs (VOUTR and HPR). The user can set this bit to mute the bypass path while retaining the previous gain setting in BPVR[6:0], so that the PGA returns to the previous gain setting when BPMUR is cleared. When the BPMUR bit is set, the PGA soft-steps down to its lowest level, then the bypass path is muted. This procedure is used to reduce any audible artifacts (pops or clicks) during the mute operation. This soft-stepping process is reversed when the BPMUR bit is cleared (unmute).

Table 37. Right Channel Audio Bypass Mute

BPMUR	DESCRIPTION
0	Right channel audio bypass path is active.
1	Right channel audio bypass path is mute. (default)

Bits [6:0] BPVR6- BPVR0

Right Channel Audio Bypass Path Volume Control. These 7 bits control the gain setting of the right channel bypass path volume control PGA. This volume control can be programmed from -35.5 dB to +12 dB in 0.5-dB steps. Full volume (+12 dB) corresponds to a setting of 7Fh. Unity gain (0 dB) corresponds to 67h. Full attenuation (-35.5 dB) corresponds to 20h. Any value lower than 20h engages the mute function described above. The default volume setting is 0 dB.

BPVR[6:0] = 1100111 (103d) = 0 dB (default)

BPVR[6:0] = 1111111 (127d) = +12 dB (Max)

BPVR[6:0] = 0100000 (032d) = -35.5 dB (Min)

BPVR[6:0] = 0d-31d = mute

KEYCLICK CONTROL REGISTER (Page 2, Address 04H)

The Keyclick Control Register of the TSC2300 controls the setup of the internal keyclick sound generator. This register is used to initiate and set the frequency, amplitude, and duration of the internally generated keyclick sound. This register also controls the input to the differential mono output, and the soft-stepping function of the TSC2300 volume controls.

The keyclick control register is formatted as follows:

Bit 15 MSB	Bit 14	Bit 13	Bit 12	Bit 11	Bit 10	Bit 9	Bit 8	Bit 7	Bit 6	Bit 5	Bit 4	Bit 3	Bit 2	Bit 1	Bit 0 LSB
KEYST	KCAM2	KCAM1	KCAM0	RESV	KCFR2	KCFR1	KCFR0	KCLN3	KCLN2	KCLN1	KCLN0	RESV	MONS	SSRTE	SSTEP

Bit 15 KEYST

Keyclick Start. This bit initiates a keyclick sound.

Table 38. Keyclick Start

KEYST	Description
0	No keyclick sound (default)
1	Initiate a keyclick sound

Bits [14:12] KCAM2-KCAM0

Keyclick Amplitude. These bits set the amplitude of the keyclick sound with eight amplitude levels provided.

KCAM[2:0] = 100 = Medium amplitude (default)

KCAM[2:0] = 111 = Maximum amplitude

KCAM[2:0] = 000 = Minimum amplitude

Bit 11 RESERVED

This bit is reserved, and should be written to 0. If read, it will read back as 0.

Bits [10:8] KCFR2-KCFR0

Keyclick Frequency. These bits set the frequency of the keyclick sound (frequencies are approximate).

Table 39. Keyclick Frequency

KCFR2	KCFR1	KCFR0	KEYCLICK TONE FREQUENCY
0	0	0	62.5 Hz
0	0	1	125 Hz
0	1	0	250 Hz
0	1	1	500 Hz
1	0	0	1 k Hz (default)
1	0	1	2 k Hz
1	1	0	4 k Hz
1	1	1	8 k Hz

Bits [7:4] KCLN3-KCLN0

Keyclick Length. These bits set the approximate duration of the keyclick sound, 16 settings for duration are provided. The formula for the number of periods heard is:

$$N_{\text{periods}} = (KCLN + 1) \times 2 \tag{13}$$

KCLN[3:0] = 0000 = 2 periods of the keyclick sound (min)

TSC2300

SLAS372 — NOVEMBER 2002

KCLN[3:0] = 0001 = 4 periods of the keyclick sound (default)

KCLN[3:0] = 0010 = 6 periods of the keyclick sound

KCLN[3:0] = 0011 = 8 periods of the keyclick sound

KCLN[3:0] = 1111 = 32 periods of the keyclick sound (max)

Bit 3 RESERVED

This bit is reserved, and should be written as 0. If read, it is read back as 0.

Bit 2 MONS

Mono Select. This bit determines the position of the Mono multiplexer. This multiplexer allows either the audio ADC input or the mono mix of the stereo line outputs to be played out the differential mono output (MONO+/-).

Table 40. Mono Select

MONS	DESCRIPTION
0	Mono output comes from ADC input (default)
1	Mono output comes from mono mix of line outputs

Bit 1 SSRTE

Volume Soft-stepping Rate Select. This bit selects the speed of the soft-stepping function of the TSC2300 volume controls. At normal speed, the actual volume is updated approximately once every 20 μ s. At half speed, the actual volume is updated approximately once every 40 μ s.

Table 41. Volume Soft-Stepping Rate Select

SSRTE	DESCRIPTION
0	Normal step rate used (default)
1	Half step rate used

Bit 0 SSTEP

Soft-step Flag. This read-only bit indicates that the TSC2300 volume control soft-stepping is completed.

Table 42. Soft-Step Flag

SSTEP	DESCRIPTION
0	Soft-stepping is not complete
1	Soft-stepping is complete (default)

AUDIO POWER CONTROL REGISTER (Page 2, Address 05H)

The audio power / miscellaneous control register of the TSC2300 controls the powering down of various audio blocks of the TSC2300. The default state of the TSC2300 has all audio blocks powered down. Before using any of the audio blocks, they must be powered up by writing to this register. This register also controls the crystal oscillator clock and buffer, the bass-boost filter, and the de-emphasis filter.

The audio power / miscellaneous control register is formatted as follows:

BIT 15 MSB	BIT 14	BIT 13	BIT 12	BIT 11	BIT 10	BIT 9	BIT 8	BIT 7	BIT 6	BIT 5	BIT 4	BIT 3	BIT 2	BIT 1	BIT 0 LSB
APD	AVPD	ABPD	HAPD	MOPD	DAPD	ADPDL	RESV	PDSTS	MIBPD	OSCC	BCKC	SMPD	OTSYN	BASS	DEEMP

For bits 15 through 8 of this register, writing a 1 to a selected bit powers down the affected section, writing a 0 powers up the section.

Bit 15 APD

Audio Power Down. This bit powers down the entire audio section if set, regardless of the settings of the other bits in this register. When this bit is cleared, the individual sections of the audio codec still need to be powered up individually. The settings of the other bits in the register are retained when this bit is set and cleared. The default is 1 (powered down).

Bit 14 AVPD

Audio VCM Power Down. If this is set to 1, the VCM will power up whenever it is needed (such as when the audio ADC, DAC, or bypass path is enabled) and powers down when no longer needed. If this bit is set to 0, after an audio component is powered up and causes VCM to power up, it no longer powers down, even if all audio components are powered down. This is intended to avoid the 500 msec delay needed for VCM to power up slowly. The default is 1 (powered down).

Bit 13 ABPD

Audio Bypass Path Power Down. This is used to power up (set to 0) or power down (set to 1) the audio bypass path. The default is 1 (powered down).

Bits 12 HAPD

Headphone Amplifier Power Down. This is used to power up (set to 0) or power down (set to 1) the headphone amplifier. The default is 1 (powered down).

Bit 11 MOPD

Mono Driver Power Down. This is used to power up (set to 0) or power down (set to 1) the mono output driver. If only playback of the line or Mic inputs through the mono output is needed, the user need only power up the mono section, and not the DAC or ADC. The line inputs, Mic preamp, ADC multiplexer and volume control all power up if the mono output is powered up. The default is 1 (powered down).

Bit 10 DAPD

DAC Power Down. This is used to power up (set to 0) or power down (set to 1) the entire stereo DAC. The default is 1 (powered down).

Bit 9 ADPDL

ADC Power Down. This is used to power up (set to 0) or power down (set to 1) the entire ADC. The line inputs, Mic preamp, ADC multiplexer and volume control all automatically power up when the ADC is powered up. The default is 1 (powered down).

Bit 8 Reserved

The default is 1 (powered down).

Bit 7 PDSTS

Power Up/Down Done. This read-only bit indicates that all power-up or power-down processes requested are completed.

Table 43. Power Up/Down Flag

PDSTS	DESCRIPTION
0	Power up/down is not complete
1	Power up/down is complete (default)

Bit 6 MIBPD

Microphone Bias Power Down. This is used to power up (set to 0) or power down (set to 1) the Microphone Bias Output.

Table 44. Microphone Bias Power Down

OSCC	DESCRIPTION
0	Microphone bias is on (default).
1	Microphone bias is off.

TSC2300

SLAS372 — NOVEMBER 2002

Bit 5 OSCC

Crystal Oscillator Control. The TSC2300 includes a crystal oscillator that can be used to generate the signal needed for the MCLK input, or any other purpose. However, it is not necessary to use the crystal oscillator. No function of the TSC2300 requires use of the crystal oscillator

The OSCC bit in this register controls the crystal oscillator as described in Table 44.

Table 45. Crystal Oscillator Control

OSCC	DESCRIPTION
0	Crystal oscillator is off.
1	Crystal oscillator is on (default).

Bit 4 BCKC

Oscillator Clock Buffer Control. If the crystal oscillator is used to provide a clock for another part, a buffered version of the oscillator clock can be obtained from pin 13 (GPIO_5/CLKO). The BCKC bit in this register determines whether or not the buffered oscillator clock is driven. Note that GPIO_5 must be configured as an output for this option to fully function.

Table 46. Oscillator Clock Buffer Control

BCKC	DESCRIPTION
0	The output clock buffer is off (default).
1	The output clock buffer is on.

Bit 3 SMPD

Synchronization Monitor Power Down. The TSC2300 contains circuitry to monitor the I²S bus LRCLK and BCLK clocks and provide a flag to the system if they appear unsynchronized. When this synchronization monitor detects a possible out-of-sync condition, it flags the data converter, which causes them to stop and wait for the bus to resynchronize. The SMPD bit is used to enable or disable the operation of this circuitry.

Table 47. Synchronization Monitor Power Down

SMPD	DESCRIPTION
0	The I ² S bus sync monitor is on (default).
1	The I ² S bus sync monitor is off.

Bit 2 OTSYN

I²S Out Of Sync. This read-only sticky bit reflects the sync status of the I²S bus. It will always reset to zero after being read.

Table 48. I²S Out of Sync

OTSYN	DESCRIPTION
0	The I ² S bus is in sync.
1	The I ² S bus is out of sync (default).

Bit 1 BASS

Digital-effects filter control. This bit turns ON/OFF the digital-effects filter. If the digital-effects filter is off, the signal passes through with no filtering performed.

Table 49. Digital-Effects Filter Control

Digital-Effects Filter Control (continued)

BASS	DESCRIPTION
0	The digital-effects filter is off (default).
1	The digital-effects filter is on.

Bit 0 DEEMP

De-emphasis control. This bit turns ON/OFF the de-emphasis function.

Table 50. De-emphasis Control

DEEMP	DESCRIPTION
0	De-emphasis is off (default).
1	De-emphasis is on.

GPIO CONTROL REGISTER (Page 02, Address 06h)

The GPIO control register controls the GPIO pins of the TSC2300. The direction of each GPIO pin can be set independently. For GPIOs configured as output pins, the data to be driven is written to this register. For GPIO's configured as inputs, the input data can be read from this register. This register also contains a bit, SDAVB which mirrors the state of the DAVB output line.

The GPIO Control Register is formatted as follows:

BIT 15 MSB	BIT 14	BIT 13	BIT 12	BIT 11	BIT 10	BIT 9	BIT 8	BIT 7	BIT 6	BIT 5	BIT 4	BIT 3	BIT 2	BIT 1	BIT 0 LSB
RESV	RESV	IO5	IO 4	IO 3	IO 2	IO 1	IO 0	RESV	RESV	GPIO5	GPIO4	GPIO3	GPIO2	GPIO 1	GPIO 0

Bits 15,14 RESERVED

These bits are reserved and should be written to 0. If read, they will read back as 0.

Bits [13:8] IO5- IO0

GPIO Directional Control. These 6 bits control the direction of the TSC2300's six GPIO pins. When one of these bits is set to one, the corresponding GPIO pin is configured as an output. When one of these bits is set to zero, the corresponding GPIO pin is configured as an input. The default setting of these bits is zero (all inputs).

Bits 7,6 RESERVED

These bits are reserved, and should be written to 0. If read, they read back as 0.

Bits [5:0] GPIO5- GPIO0

GPIO Data. These bits control the data on the GPIO pins. When a GPIO pin is configured as an output, the data written to one of these bits is driven on the corresponding GPIO pin. When a GPIO pin is configured as an input, the data input on the GPIO pin is returned to the corresponding register bit, and can be read by the host processor.

DAC BASS-BOOST FILTER COEFFICIENT REGISTERS (Page 02, Addresses 07h-1Ah)

The DAC bass-boost coefficient registers implement the transfer function described . The coefficients are represented by 16-bit 2s complement integers with values ranging from -32768 to +32767.

The DAC bass-boost coefficient registers are formatted as follows:

BIT 15 MSB	BIT 14	BIT 13	BIT 12	BIT 11	BIT 10	BIT 9	BIT 8	BIT 7	BIT 6	BIT 5	BIT 4	BIT 3	BIT 2	BIT 1	BIT 0 LSB
D15	D14	D13	D12	D11	D10	D9	D8	D7	D6	D5	D4	D3	D2	D1	D0

Table 51. DAC Bass-Boost Coefficient Registers

TSC2300

SLAS372 — NOVEMBER 2002

DAC Bass-Boost Coefficient Registers (continued)

ADDRESS	DAC CHANNEL	COEFFICIENT	DEFAULT
07h	Left	N0	6BE2
08h	Left	N1	9667
09h	Left	N2	675D
0Ah	Left	N3	6BE2
0Bh	Left	N4	9667
0Ch	Left	N5	675D
0Dh	Left	D1	7D82
0Eh	Left	D2	84EF
0Fh	Left	D4	7D82
10h	Left	D5	84EF
11h	Right	N0	6BE2
12h	Right	N1	9667
13h	Right	N2	675D
14h	Right	N3	6BE2
15h	Right	N4	9667
16h	Right	N5	675D
17h	Right	D1	7D82
18h	Right	D2	84EF
19h	Right	D4	7D82
1Ah	Right	D5	84EF

LAYOUT

The following layout suggestions should provide optimum performance from the TSC2300. However, many portable applications have conflicting requirements concerning power, cost, size, and weight. In general, most portable devices have fairly clean power and grounds because most of the internal components are very low power. This situation would mean less bypassing for the converter's power and less concern regarding grounding. Still, each situation is unique and the following suggestions should be reviewed carefully.

For optimum performance, care should be taken with the physical layout of the TSC2300 circuitry. The basic SAR architecture is sensitive to glitches or sudden changes on the power supply, reference, ground connections, and digital inputs that occur just prior to latching the output of the analog comparator. Therefore, during any single conversion for an n-bit SAR converter, there are n windows in which large external transient voltages can easily affect the conversion result. Such glitches might originate from switching power supplies, nearby digital logic, and high power devices. The degree of error in the digital output depends on the reference voltage, layout, and the exact timing of the external event. The error can change if the external event changes in time with respect to the internal conversion clock. The touch screen circuitry, as well as the audio headphone amplifiers, uses the HPVDD/HPGND supplies for its power, and any noise on this supply may adversely affect performance in these blocks.

As described earlier, the audio common-mode voltage VCM is derived directly through an internal resistor divider between AVDD and AGND. Therefore, noise that couples onto AVDD/AGND will be translated onto VCM and can adversely impact audio performance. The reference pins for the audio data converters, VREF+/VREF-, should also be kept as clean and noise-free as possible, since noise here will affect audio DAC/ADC quality. De-coupling capacitors are recommended between VREF+ and VREF-, in addition to a series resistance between VREF+ and the source of the voltage (such as connecting to the source providing AVDD).

With this in mind, power to the TSC2300 should be clean and well bypassed. A 0.1- μ F ceramic bypass capacitor should be placed as close to the device as possible on each supply pin to its respective ground pin. A 1- μ F to 10- μ F capacitor may also be needed if the impedance of the connection between a supply and the power supply is high.

A bypass capacitor on the SAR Vref pin may not be absolutely necessary because this reference is buffered by an internal op amp, but a 0.1 μ F bypass capacitor may reduce noise on this reference. If an external reference voltage originates from an op amp, make sure that it can drive any bypass capacitor that is used without oscillation.

The TSC2300 SAR converter architecture offers no inherent rejection of noise or voltage variation in regards to using an external reference input. This is of particular concern when the reference input is tied to the power supply. Any noise and ripple from the supply appears directly in the digital results. While high frequency noise can be filtered out, voltage variation due to line frequency (50 Hz or 60 Hz) can be difficult to remove.

The HPGND pin should be connected to a clean ground point. In many cases, this is the analog ground for the SAR converter. Avoid connections which are too near the grounding point of a microcontroller or digital signal processor. If needed, run a ground trace directly from the converter to the power supply entry or battery connection point. The ideal layout includes an analog ground plane dedicated to the converter and associated analog circuitry.

In the specific case of use with a resistive touch screen, care should be taken with the connection between the converter and the touch screen. Since resistive touch screens have fairly low resistance, the interconnection should be as short and robust as possible. Loose connections can be a source of error when the contact resistance changes with flexing or vibrations.

As indicated previously, noise can be a major source of error in touch screen applications (e.g., applications that require a back-lit LCD panel). This EMI noise can be coupled through the LCD panel to the touch screen and cause flickering of the converted data. Several things can be done to reduce this error, such as utilizing a touch screen with a bottom-side metal layer connected to ground. This couples the majority of noise to ground. Additionally, filtering capacitors, from Y+, Y-, X+, and X- to ground, can also help. Note, however, that the use of these capacitors increases screen settling time and requires longer panel voltage stabilization times, as well as increased precharge and sense times for the touch screen control circuitry of the TSC2300.

MECHANICAL DATA

PAG (S-PQFP-G64)

PLASTIC QUAD FLATPACK

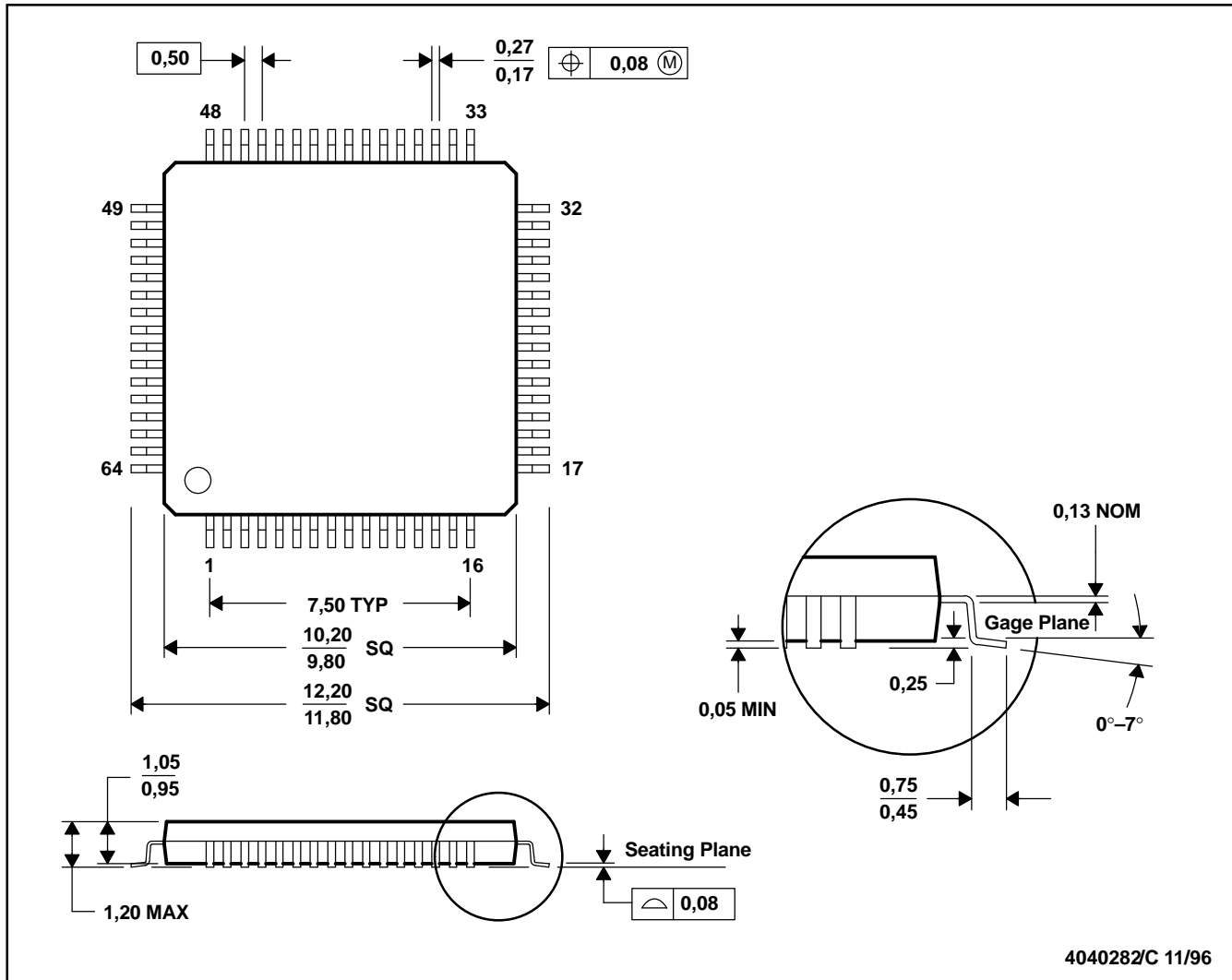

- (A) All linear dimensions are in millimeters.
- (B) This drawing is subject to change without notice.
- (C) Falls within JEDEC MS-026

PACKAGING INFORMATION

Orderable Device	Status ⁽¹⁾	Package Type	Package Drawing	Pins	Package Qty	Eco Plan ⁽²⁾	Lead/Ball Finish	MSL Peak Temp ⁽³⁾
TSC2300IPAG	ACTIVE	TQFP	PAG	64	160	None	CU NIPDAU	Level-2-235C-1 YEAR
TSC2300IPAGR	ACTIVE	TQFP	PAG	64	1500	None	CU NIPDAU	Level-2-235C-1 YEAR

⁽¹⁾ The marketing status values are defined as follows:

ACTIVE: Product device recommended for new designs.

LIFEBUY: TI has announced that the device will be discontinued, and a lifetime-buy period is in effect.

NRND: Not recommended for new designs. Device is in production to support existing customers, but TI does not recommend using this part in a new design.

PREVIEW: Device has been announced but is not in production. Samples may or may not be available.

OBsolete: TI has discontinued the production of the device.

⁽²⁾ Eco Plan - May not be currently available - please check <http://www.ti.com/productcontent> for the latest availability information and additional product content details.

None: Not yet available Lead (Pb-Free).

Pb-Free (RoHS): TI's terms "Lead-Free" or "Pb-Free" mean semiconductor products that are compatible with the current RoHS requirements for all 6 substances, including the requirement that lead not exceed 0.1% by weight in homogeneous materials. Where designed to be soldered at high temperatures, TI Pb-Free products are suitable for use in specified lead-free processes.

Green (RoHS & no Sb/Br): TI defines "Green" to mean "Pb-Free" and in addition, uses package materials that do not contain halogens, including bromine (Br) or antimony (Sb) above 0.1% of total product weight.

⁽³⁾ MSL, Peak Temp. -- The Moisture Sensitivity Level rating according to the JEDEC industry standard classifications, and peak solder temperature.

Important Information and Disclaimer: The information provided on this page represents TI's knowledge and belief as of the date that it is provided. TI bases its knowledge and belief on information provided by third parties, and makes no representation or warranty as to the accuracy of such information. Efforts are underway to better integrate information from third parties. TI has taken and continues to take reasonable steps to provide representative and accurate information but may not have conducted destructive testing or chemical analysis on incoming materials and chemicals. TI and TI suppliers consider certain information to be proprietary, and thus CAS numbers and other limited information may not be available for release.

In no event shall TI's liability arising out of such information exceed the total purchase price of the TI part(s) at issue in this document sold by TI to Customer on an annual basis.

PAG (S-PQFP-G64)

PLASTIC QUAD FLATPACK



- NOTES: A. All linear dimensions are in millimeters.
 B. This drawing is subject to change without notice.
 C. Falls within JEDEC MS-026

IMPORTANT NOTICE

Texas Instruments Incorporated and its subsidiaries (TI) reserve the right to make corrections, modifications, enhancements, improvements, and other changes to its products and services at any time and to discontinue any product or service without notice. Customers should obtain the latest relevant information before placing orders and should verify that such information is current and complete. All products are sold subject to TI's terms and conditions of sale supplied at the time of order acknowledgment.

TI warrants performance of its hardware products to the specifications applicable at the time of sale in accordance with TI's standard warranty. Testing and other quality control techniques are used to the extent TI deems necessary to support this warranty. Except where mandated by government requirements, testing of all parameters of each product is not necessarily performed.

TI assumes no liability for applications assistance or customer product design. Customers are responsible for their products and applications using TI components. To minimize the risks associated with customer products and applications, customers should provide adequate design and operating safeguards.

TI does not warrant or represent that any license, either express or implied, is granted under any TI patent right, copyright, mask work right, or other TI intellectual property right relating to any combination, machine, or process in which TI products or services are used. Information published by TI regarding third-party products or services does not constitute a license from TI to use such products or services or a warranty or endorsement thereof. Use of such information may require a license from a third party under the patents or other intellectual property of the third party, or a license from TI under the patents or other intellectual property of TI.

Reproduction of information in TI data books or data sheets is permissible only if reproduction is without alteration and is accompanied by all associated warranties, conditions, limitations, and notices. Reproduction of this information with alteration is an unfair and deceptive business practice. TI is not responsible or liable for such altered documentation.

Resale of TI products or services with statements different from or beyond the parameters stated by TI for that product or service voids all express and any implied warranties for the associated TI product or service and is an unfair and deceptive business practice. TI is not responsible or liable for any such statements.

Following are URLs where you can obtain information on other Texas Instruments products and application solutions:

Products		Applications	
Amplifiers	amplifier.ti.com	Audio	www.ti.com/audio
Data Converters	dataconverter.ti.com	Automotive	www.ti.com/automotive
DSP	dsp.ti.com	Broadband	www.ti.com/broadband
Interface	interface.ti.com	Digital Control	www.ti.com/digitalcontrol
Logic	logic.ti.com	Military	www.ti.com/military
Power Mgmt	power.ti.com	Optical Networking	www.ti.com/opticalnetwork
Microcontrollers	microcontroller.ti.com	Security	www.ti.com/security
		Telephony	www.ti.com/telephony
		Video & Imaging	www.ti.com/video
		Wireless	www.ti.com/wireless

Mailing Address: Texas Instruments
Post Office Box 655303 Dallas, Texas 75265