

# TPS75201Q, TPS75215Q, TPS75218Q, TPS75225Q, TPS75233Q WITH RESET TPS75401Q, TPS75415Q, TPS75418Q, TPS75425Q, TPS75433Q WITH POWER GOOD FAST-TRANSIENT-RESPONSE 2-A LOW-DROPOUT VOLTAGE REGULATORS

SLVS242B – MARCH 2000 – REVISED JUNE 2003

- 2-A Low-Dropout Voltage Regulator
- Available in 1.5-V, 1.8-V, 2.5-V, 3.3-V Fixed Output and Adjustable Versions
- Open Drain Power-On Reset With 100-ms Delay (TPS752xxQ)
- Open Drain Power-Good (PG) Status Output (TPS754xxQ)
- Dropout Voltage Typically 210 mV at 2 A (TPS75233Q)
- Ultralow 75- $\mu$ A Typical Quiescent Current
- Fast Transient Response
- 2% Tolerance Over Specified Conditions for Fixed-Output Versions
- 20-Pin TSSOP (PWP) PowerPAD™ Package
- Thermal Shutdown Protection

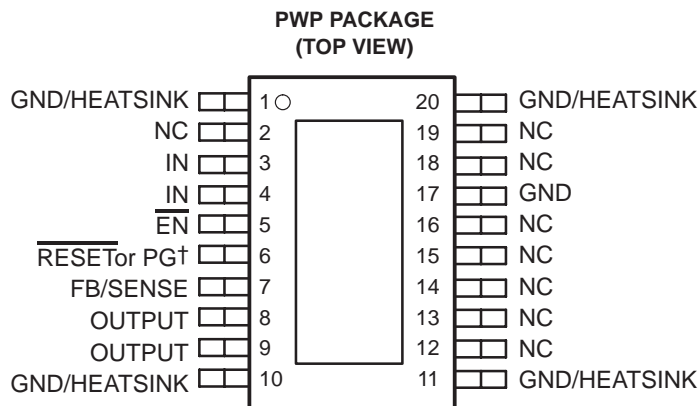

NC – No internal connection  
† PG is on the TPS754xx and RESET is on the TPS752xx

## description

The TPS752xxQ and TPS754xxQ are low dropout regulators with integrated power-on reset and power good (PG) functions respectively. These devices are capable of supplying 2 A of output current with a dropout of 210 mV (TPS75233Q, TPS75433Q). Quiescent current is 75  $\mu$ A at full load and drops down to 1  $\mu$ A when the device is disabled. TPS752xxQ and TPS754xxQ are designed to have fast transient response for larger load current changes.

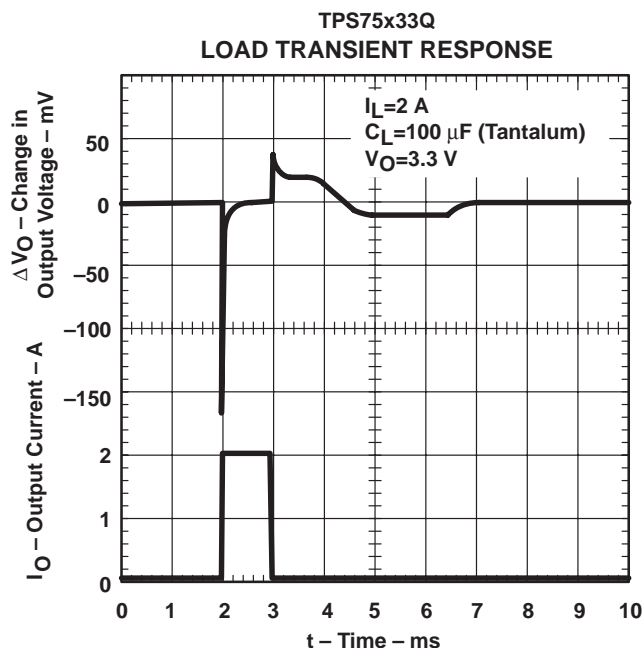
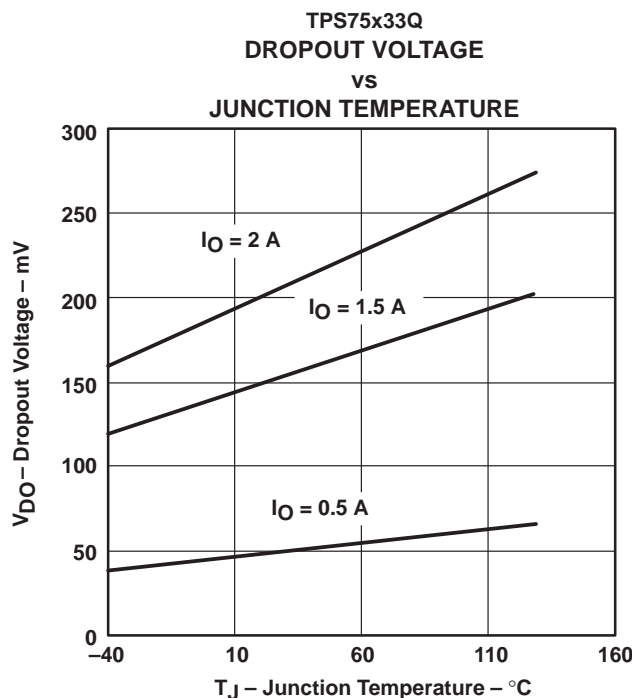

Please be aware that an important notice concerning availability, standard warranty, and use in critical applications of Texas Instruments semiconductor products and disclaimers thereto appears at the end of this data sheet.

PowerPAD is a trademark of Texas Instruments.

PRODUCTION DATA information is current as of publication date. Products conform to specifications per the terms of Texas Instruments standard warranty. Production processing does not necessarily include testing of all parameters.

**TEXAS  
INSTRUMENTS**

POST OFFICE BOX 655303 • DALLAS, TEXAS 75265

Copyright © 2000 – 2003, Texas Instruments Incorporated

**TPS75201Q, TPS75215Q, TPS75218Q, TPS75225Q, TPS75233Q WITH  $\overline{\text{RESET}}$   
 TPS75401Q, TPS75415Q, TPS75418Q, TPS75425Q, TPS75433Q WITH POWER GOOD  
 FAST-TRANSIENT-RESPONSE 2-A LOW-DROPOUT VOLTAGE REGULATORS**

SLVS242B – MARCH 2000 – REVISED JUNE 2003

**description (continued)**

Because the PMOS device behaves as a low-value resistor, the dropout voltage is very low (typically 210 mV at an output current of 2 A for the TPS75x33Q) and is directly proportional to the output current. Additionally, since the PMOS pass element is a voltage-driven device, the quiescent current is very low and independent of output loading (typically 75  $\mu\text{A}$  over the full range of output current, 1 mA to 2 A). These two key specifications yield a significant improvement in operating life for battery-powered systems.

The device is enabled when the  $\overline{\text{EN}}$  pin is connected to a low-level input voltage. This LDO family also features a sleep mode; applying a TTL high signal to  $\overline{\text{EN}}$  (enable) shuts down the regulator, reducing the quiescent current to 1  $\mu\text{A}$  at  $T_J = 25^\circ\text{C}$ .

The  $\overline{\text{RESET}}$  (SVS, POR, or power on reset) output of the TPS752xxQ initiates a reset in microcomputer and microprocessor systems in the event of an undervoltage condition. An internal comparator in the TPS752xxQ monitors the output voltage of the regulator to detect an undervoltage condition on the regulated output voltage. When the output reaches 95% of its regulated voltage,  $\overline{\text{RESET}}$  goes to a high-impedance state after a 100-ms delay.  $\overline{\text{RESET}}$  goes to a logic-low state when the regulated output voltage is pulled below 95% (i.e., over load condition) of its regulated voltage.

The TPS754xxQ has a power good terminal (PG) as an active high, open drain output, which can be used to implement a power-on reset or a low-battery indicator.

The TPS752xxQ or the TPS754xxQ are offered in 1.5-V, 1.8-V, 2.5-V, and 3.3-V fixed-voltage versions and in an adjustable version (programmable over the range of 1.5 V to 5 V). Output voltage tolerance is specified as a maximum of 2% over line, load, and temperature ranges. The TPS752xxQ and the TPS754xxQ families are available in 20 pin TSSOP (PWP) packages.

**AVAILABLE OPTIONS**

T <sub>J</sub>	OUTPUT VOLTAGE (TYP)	TSSOP (PWP)	
		RESET	PG
-40°C to 125°C	3.3 V	TPS75233QPWP	TPS75433QPWP
	2.5 V	TPS75225QPWP	TPS75425QPWP
	1.8 V	TPS75218QPWP	TPS75418QPWP
	1.5 V	TPS75215QPWP	TPS75415QPWP
	Adjustable 1.5 V to 5 V	TPS75201QPWP	TPS75401QPWP

The TPS75x01 is programmable using an external resistor divider (see application information). The PWP package is available taped and reeled. Add an R suffix to the device type (e.g., TPS75201QPWPR) to indicate tape and reel.

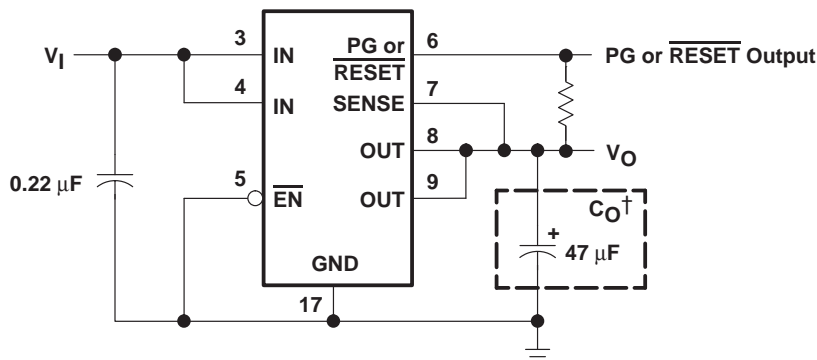

† See application information section for capacitor selection details.

**Figure 1. Typical Application Configuration (For Fixed Output Options)**



TPS75201Q, TPS75215Q, TPS75218Q, TPS75225Q, TPS75233Q WITH RESET  
 TPS75401Q, TPS75415Q, TPS75418Q, TPS75425Q, TPS75433Q WITH POWER GOOD  
 FAST-TRANSIENT-RESPONSE 2-A LOW-DROPOUT VOLTAGE REGULATORS

SLVS242B – MARCH 2000 – REVISED JUNE 2003

functional block diagram—adjustable version

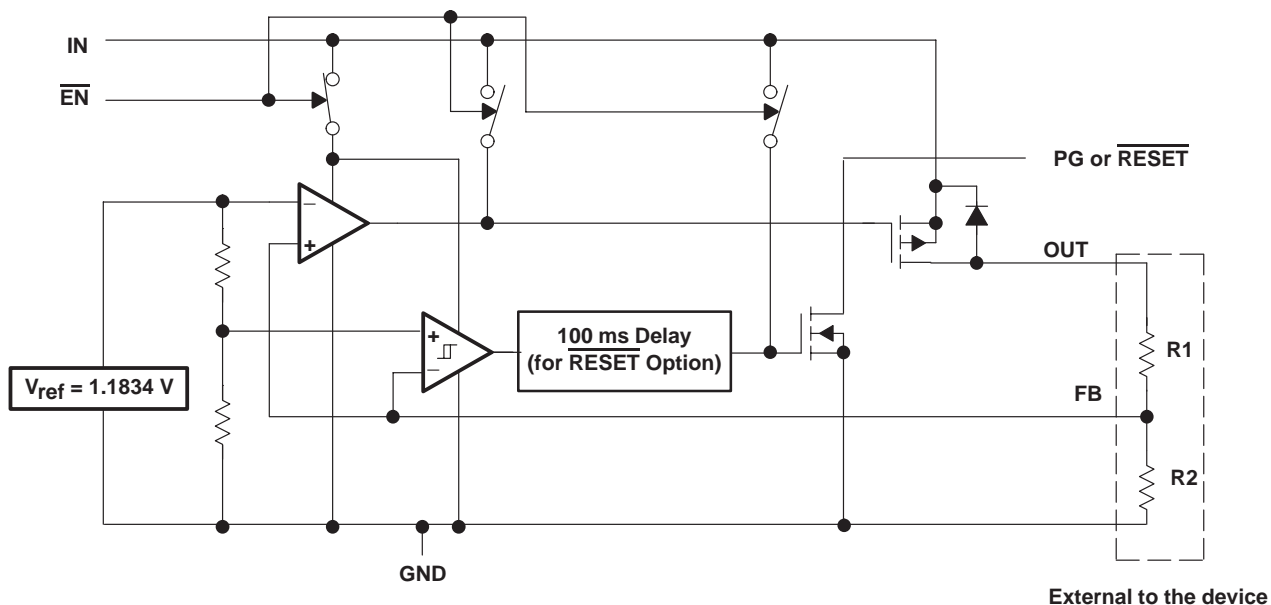

functional block diagram—fixed-voltage version

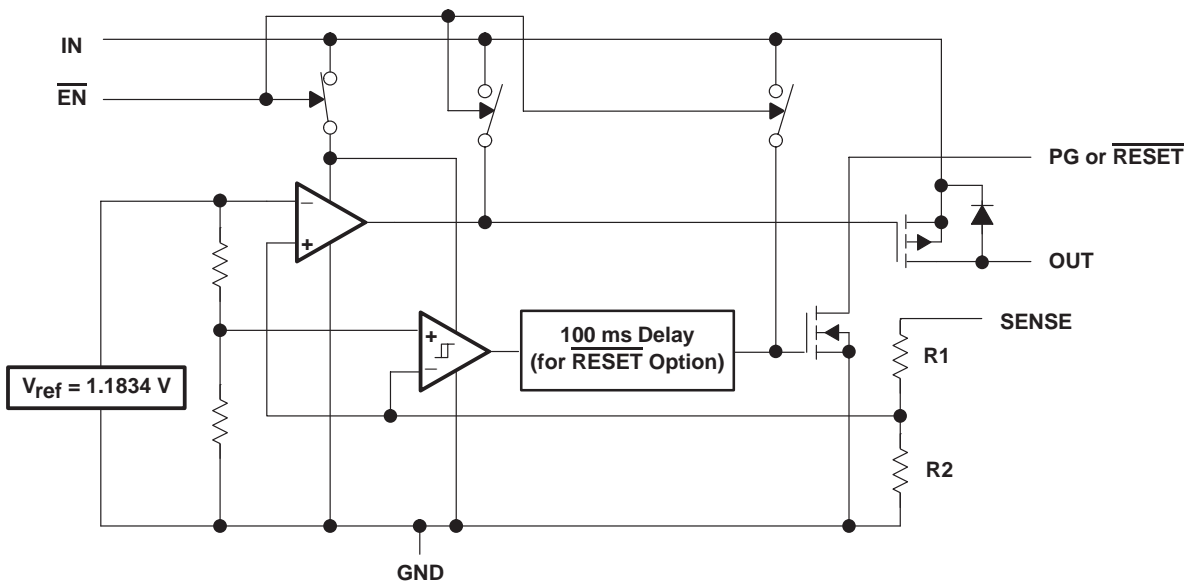

**TPS75201Q, TPS75215Q, TPS75218Q, TPS75225Q, TPS75233Q WITH RESET  
 TPS75401Q, TPS75415Q, TPS75418Q, TPS75425Q, TPS75433Q WITH POWER GOOD  
 FAST-TRANSIENT-RESPONSE 2-A LOW-DROPOUT VOLTAGE REGULATORS**

SLVS242B – MARCH 2000 – REVISED JUNE 2003

**Terminal Functions (TPS752xxQ)**

TERMINAL NAME	NO.	I/O	DESCRIPTION
$\overline{\text{EN}}$	5	I	Enable Input
FB/SENSE	7	I	Feedback input voltage for adjustable device (sense input for fixed-voltage option)
GND	17		Regulator ground
GND/HEATSINK	1, 10, 11, 20		Ground/heatsink
IN	3, 4	I	Input voltage
NC	2, 12, 13, 14, 15, 16, 18, 19		No connection
OUTPUT	8, 9	O	Regulated output voltage
$\overline{\text{RESET}}$	6	O	Reset output

**Terminal Functions (TPS754xxQ)**

TERMINAL NAME	NO.	I/O	DESCRIPTION
$\overline{\text{EN}}$	5	I	Enable Input
FB/SENSE	7	I	Feedback input voltage for adjustable device (sense input for fixed-voltage option)
GND	17		Regulator ground
GND/HEATSINK	1, 10, 11, 20		Ground/heatsink
IN	3, 4	I	Input voltage
NC	2, 12, 13, 14, 15, 16, 18, 19		No connection
OUTPUT	8, 9	O	Regulated output voltage
PG	6	O	Power good output



TPS75201Q, TPS75215Q, TPS75218Q, TPS75225Q, TPS75233Q WITH  $\overline{\text{RESET}}$   
 TPS75401Q, TPS75415Q, TPS75418Q, TPS75425Q, TPS75433Q WITH POWER GOOD  
 FAST-TRANSIENT-RESPONSE 2-A LOW-DROPOUT VOLTAGE REGULATORS

SLVS242B – MARCH 2000 – REVISED JUNE 2003

TPS752xxQ  $\overline{\text{RESET}}$  timing diagram

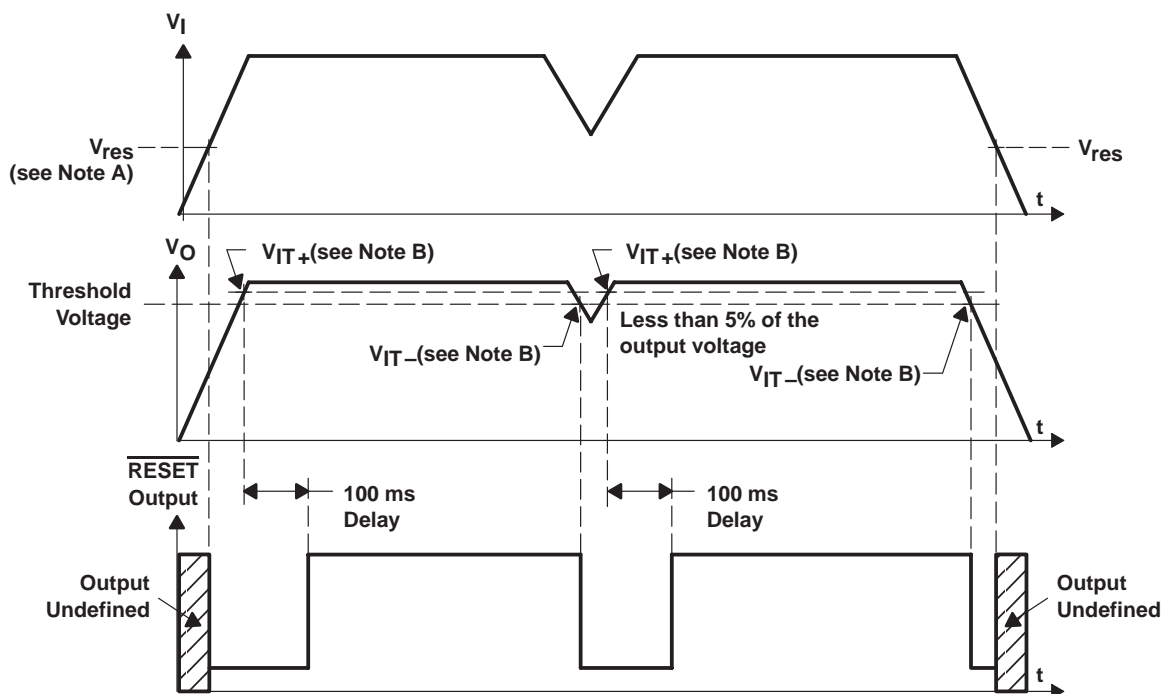

- NOTES: A.  $V_{res}$  is the minimum input voltage for a valid  $\overline{\text{RESET}}$ . The symbol  $V_{res}$  is not currently listed within EIA or JEDEC standards for semiconductor symbology.
- B.  $V_{IT-}$  Trip voltage is typically 5% lower than the output voltage ( $95\%V_o$ ).  $V_{IT-}$  to  $V_{IT+}$  is the hysteresis voltage.

TPS75201Q, TPS75215Q, TPS75218Q, TPS75225Q, TPS75233Q WITH RESET  
 TPS75401Q, TPS75415Q, TPS75418Q, TPS75425Q, TPS75433Q WITH POWER GOOD  
 FAST-TRANSIENT-RESPONSE 2-A LOW-DROPOUT VOLTAGE REGULATORS

SLVS242B – MARCH 2000 – REVISED JUNE 2003

TPS754xxQ PG timing diagram

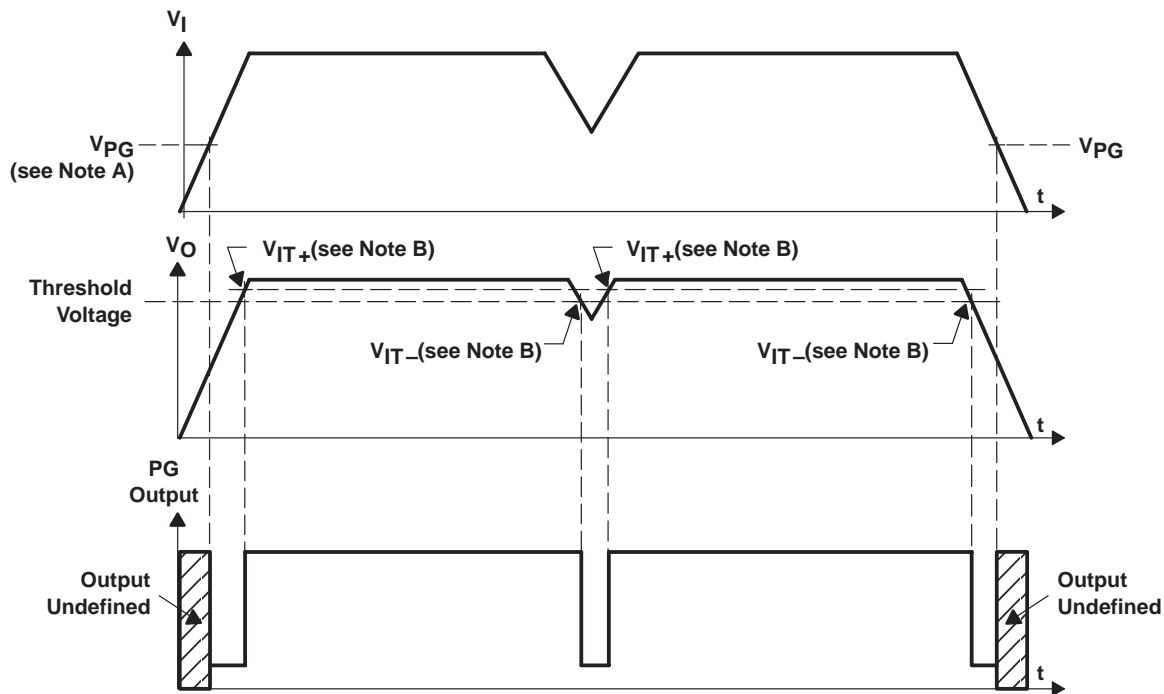

- NOTES: A.  $V_{PG}$  is the minimum input voltage for a valid PG. The symbol  $V_{PG}$  is not currently listed within EIA or JEDEC standards for semiconductor symbology.
- B.  $V_{IT-}$  Trip voltage is typically 17% lower than the output voltage ( $83\%V_O$ )  $V_{IT-}$  to  $V_{IT+}$  is the hysteresis voltage.

**TPS75201Q, TPS75215Q, TPS75218Q, TPS75225Q, TPS75233Q WITH RESET  
TPS75401Q, TPS75415Q, TPS75418Q, TPS75425Q, TPS75433Q WITH POWER GOOD  
FAST-TRANSIENT-RESPONSE 2-A LOW-DROPOUT VOLTAGE REGULATORS**

SLVS242B – MARCH 2000 – REVISED JUNE 2003

**absolute maximum ratings over operating junction temperature range (unless otherwise noted)†**

Input voltage range‡, $V_I$ .....	–0.3 V to 6.0 V
Voltage range at $\overline{EN}$ .....	–0.3 V to 16.5 V
Maximum $\overline{RESET}$ voltage (TPS752xxQ) .....	16.5 V
Maximum PG voltage (TPS754xxQ) .....	16.5 V
Peak output current .....	Internally limited
Output voltage, $V_O$ (OUTPUT, FB) .....	5.5 V
Continuous total power dissipation .....	See dissipation rating tables
Operating virtual junction temperature range, $T_J$ .....	–40°C to 125°C
Storage temperature range, $T_{Stg}$ .....	–65°C to 150°C
ESD rating, HBM .....	2 kV

† Stresses beyond those listed under “absolute maximum ratings” may cause permanent damage to the device. These are stress ratings only, and functional operation of the device at these or any other conditions beyond those indicated under “recommended operating conditions” is not implied. Exposure to absolute-maximum-rated conditions for extended periods may affect device reliability.

‡ All voltage values are with respect to network terminal ground.

**DISSIPATION RATING TABLE 1 – FREE-AIR TEMPERATURES**

PACKAGE	AIR FLOW (CFM)	$T_A < 25^\circ\text{C}$ POWER RATING	DERATING FACTOR ABOVE $T_A = 25^\circ\text{C}$	$T_A = 70^\circ\text{C}$ POWER RATING	$T_A = 85^\circ\text{C}$ POWER RATING
PWP§	0	2.9 W	23.5 mW/°C	1.9 W	1.5 W
	300	4.3 W	34.6 mW/°C	2.8 W	2.2 W
PWP¶	0	3 W	23.8 mW/°C	1.9 W	1.5 W
	300	7.2 W	57.9 mW/°C	4.6 W	3.8 W

§ This parameter is measured with the recommended copper heat sink pattern on a 1-layer PCB, 5-in × 5-in PCB, 1 oz. copper, 2-in × 2-in coverage (4 in<sup>2</sup>).

¶ This parameter is measured with the recommended copper heat sink pattern on a 8-layer PCB, 1.5-in × 2-in PCB, 1 oz. copper with layers 1, 2, 4, 5, 7, and 8 at 5% coverage (0.9 in<sup>2</sup>) and layers 3 and 6 at 100% coverage (6 in<sup>2</sup>). For more information, refer to TI technical brief SLMA002.

**recommended operating conditions**

	MIN	MAX	UNIT
Input voltage, $V_I$ #	2.7	5.5	V
Output voltage range, $V_O$	1.5	5	V
Output current, $I_O$	0	2.0	A
Operating virtual junction temperature, $T_J$	–40	125	°C

# To calculate the minimum input voltage for your maximum output current, use the following equation:  $V_{I(\min)} = V_{O(\max)} + V_{DO(\max \text{ load})}$ .



**TPS75201Q, TPS75215Q, TPS75218Q, TPS75225Q, TPS75233Q WITH RESET**  
**TPS75401Q, TPS75415Q, TPS75418Q, TPS75425Q, TPS75433Q WITH POWER GOOD**  
**FAST-TRANSIENT-RESPONSE 2-A LOW-DROPOUT VOLTAGE REGULATORS**

SLVS242B – MARCH 2000 – REVISED JUNE 2003

**electrical characteristics over recommended operating junction temperature range ( $T_J = -40^\circ\text{C}$  to  $125^\circ\text{C}$ ),  $V_I = V_{O(\text{typ})} + 1\text{ V}$ ,  $I_O = 1\text{ mA}$ ,  $\overline{\text{EN}} = 0\text{ V}$ ,  $C_O = 47\text{ }\mu\text{F}$  (unless otherwise noted)**

PARAMETER		TEST CONDITIONS	MIN	TYP	MAX	UNIT
Output voltage (see Notes 1 and 3)	Adjustable Voltage	$1.5\text{ V} \leq V_O \leq 5.5\text{ V}$ , $T_J = 25^\circ\text{C}$	$V_O$			V
		$1.5\text{ V} \leq V_O \leq 5.5\text{ V}$	$0.98V_O$	$1.02V_O$		
	1.5 V Output	$T_J = 25^\circ\text{C}$ , $2.7\text{ V} < V_{IN} < 5.5\text{ V}$	1.5			
		$2.7\text{ V} < V_{IN} < 5.5\text{ V}$	1.470	1.530		
	1.8 V Output	$T_J = 25^\circ\text{C}$ , $2.8\text{ V} < V_{IN} < 5.5\text{ V}$	1.8			
		$2.8\text{ V} < V_{IN} < 5.5\text{ V}$	1.764	1.836		
	2.5 V Output	$T_J = 25^\circ\text{C}$ , $3.5\text{ V} < V_{IN} < 5.5\text{ V}$	2.5			
		$3.5\text{ V} < V_{IN} < 5.5\text{ V}$	2.450	2.550		
3.3 V Output	$T_J = 25^\circ\text{C}$ , $4.3\text{ V} < V_{IN} < 5.5\text{ V}$	3.3				
	$4.3\text{ V} < V_{IN} < 5.5\text{ V}$	3.234	3.366			
Quiescent current (GND current) (see Note 1)		$T_J = 25^\circ\text{C}$ , See Note 3	75			$\mu\text{A}$
		See Note 3			125	
Output voltage line regulation ( $\Delta V_O/V_O$ ) (see Notes 1 and 2)		$V_O + 1\text{ V} < V_I \leq 5.5\text{ V}$ , $T_J = 25^\circ\text{C}$ ,	0.01			%V
		$V_O + 1\text{ V} < V_I < 5.5\text{ V}$			0.1	
Load regulation (see Note 3)			1			mV
Output noise voltage		BW = 300 Hz to 50 kHz, $V_O = 1.5\text{ V}$ $C_O = 100\text{ }\mu\text{F}$ , $T_J = 25^\circ\text{C}$	60			$\mu\text{V}_{\text{rms}}$
Output current Limit		$V_O = 0\text{ V}$	3.3	4.5		A
Thermal shutdown junction temperature			150			$^\circ\text{C}$
Standby current		$\overline{\text{EN}} = V_I$ , $T_J = 25^\circ\text{C}$ ,	1			$\mu\text{A}$
		$\overline{\text{EN}} = V_I$			10	$\mu\text{A}$
FB input current	TPS75x01Q	FB = 1.5 V	-1	1		$\mu\text{A}$
High level enable input voltage			2			V
Low level enable input voltage					0.7	V
Power supply ripple rejection (see Note 2)		f = 100 Hz, $C_O = 100\text{ }\mu\text{F}$ , $T_J = 25^\circ\text{C}$ , See Note 1, $I_O = 2\text{ A}$	60			dB
Reset (TPS752xxQ)	Minimum input voltage for valid RESET	$I_{O(\text{RESET})} = 300\text{ }\mu\text{A}$ , $V(\text{RESET}) \leq 0.8\text{ V}$	1	1.3		V
	Trip threshold voltage	$V_O$ decreasing	92	98		$\%V_O$
	Hysteresis voltage	Measured at $V_O$	0.5			$\%V_O$
	Output low voltage	$V_I = 2.7\text{ V}$ , $I_{O(\text{RESET})} = 1\text{ mA}$	0.15	0.4		V
	Leakage current	$V(\text{RESET}) = 5.5\text{ V}$			1	$\mu\text{A}$
	RESET time-out delay				100	ms

NOTES: 1. Minimum IN operating voltage is 2.7 V or  $V_{O(\text{typ})} + 1\text{ V}$ , whichever is greater. Maximum IN voltage 5.5V.  
 2. If  $V_O \leq 1.8\text{ V}$  then  $V_{\text{imin}} = 2.7\text{ V}$ ,  $V_{\text{imax}} = 5.5\text{ V}$ :

$$\text{Line Reg. (mV)} = (\%/V) \times \frac{V_O(V_{\text{imax}} - 2.7\text{ V})}{100} \times 1000$$

If  $V_O \geq 2.5\text{ V}$  then  $V_{\text{imin}} = V_O + 1\text{ V}$ ,  $V_{\text{imax}} = 5.5\text{ V}$ :

$$\text{Line Reg. (mV)} = (\%/V) \times \frac{V_O(V_{\text{imax}} - (V_O + 1\text{ V}))}{100} \times 1000$$

3.  $I_O = 1\text{ mA}$  to 2 A





**TPS75201Q, TPS75215Q, TPS75218Q, TPS75225Q, TPS75233Q WITH RESET  
TPS75401Q, TPS75415Q, TPS75418Q, TPS75425Q, TPS75433Q WITH POWER GOOD  
FAST-TRANSIENT-RESPONSE 2-A LOW-DROPOUT VOLTAGE REGULATORS**

SLVS242B – MARCH 2000 – REVISED JUNE 2003

**electrical characteristics over recommended operating junction temperature range ( $T_J = -40^\circ\text{C}$  to  $125^\circ\text{C}$ ),  $V_I = V_{O(\text{typ})} + 1\text{ V}$ ,  $I_O = 1\text{ mA}$ ,  $\overline{\text{EN}} = 0\text{ V}$ ,  $C_O = 47\text{ }\mu\text{F}$  (unless otherwise noted) (continued)**

PARAMETER		TEST CONDITIONS	MIN	TYP	MAX	UNIT
PG (TPS754xxQ)	Minimum input voltage for valid PG	$I_{O(\text{PG})} = 300\text{ }\mu\text{A}$ $V(\text{PG}) \leq 0.8\text{ V}$		1.1	1.3	V
	Trip threshold voltage	$V_O$ decreasing	80		86	$\%V_O$
	Hysteresis voltage	Measured at $V_O$		0.5		$\%V_O$
	Output low voltage	$I_{O(\text{PG})} = 1\text{ mA}$		0.15	0.4	V
	Leakage current	$V(\text{PG}) = 5.5\text{ V}$			1	$\mu\text{A}$
Input current ( $\overline{\text{EN}}$ )	$\overline{\text{EN}} = V_I$		-1		1	$\mu\text{A}$
	$\overline{\text{EN}} = 0\text{ V}$		-1	0	1	$\mu\text{A}$
High level $\overline{\text{EN}}$ input voltage			2			V
Low level $\overline{\text{EN}}$ input voltage					0.7	V
Dropout voltage (3.3 V Output) (see Note 4)	$I_O = 2\text{ A}$ , $T_J = 25^\circ\text{C}$	$V_I = 3.2\text{ V}$ ,		210		mV
	$I_O = 2\text{ A}$ ,	$V_I = 3.2\text{ V}$			400	

NOTE 4:  $I_N$  voltage equals  $V_{O(\text{Typ})} - 100\text{ mV}$ ; TPS75x15Q, TPS75x18Q and TPS75x25Q dropout voltage limited by input voltage range limitations (i.e., TPS75x33Q input voltage needs to drop to 3.2 V for purpose of this test).

### Table of Graphs

		FIGURE
$V_O$	Output voltage	vs Output current
		vs Junction temperature
	Ground current	vs Junction temperature
	Power supply ripple rejection	vs Frequency
	Output spectral noise density	vs Frequency
$Z_O$	Output impedance	vs Frequency
$V_{DO}$	Dropout voltage	vs Input voltage
		vs Junction temperature
	Input voltage (min)	vs Output voltage
	Line transient response	
	Load transient response	
$V_O$	Output voltage	vs Time
	Equivalent series resistance (ESR)	vs Output current

**TPS75201Q, TPS75215Q, TPS75218Q, TPS75225Q, TPS75233Q WITH RESET  
 TPS75401Q, TPS75415Q, TPS75418Q, TPS75425Q, TPS75433Q WITH POWER GOOD  
 FAST-TRANSIENT-RESPONSE 2-A LOW-DROPOUT VOLTAGE REGULATORS**

SLVS242B – MARCH 2000 – REVISED JUNE 2003

**TYPICAL CHARACTERISTICS**

**TPS75x33Q  
 OUTPUT VOLTAGE  
 vs  
 OUTPUT CURRENT**

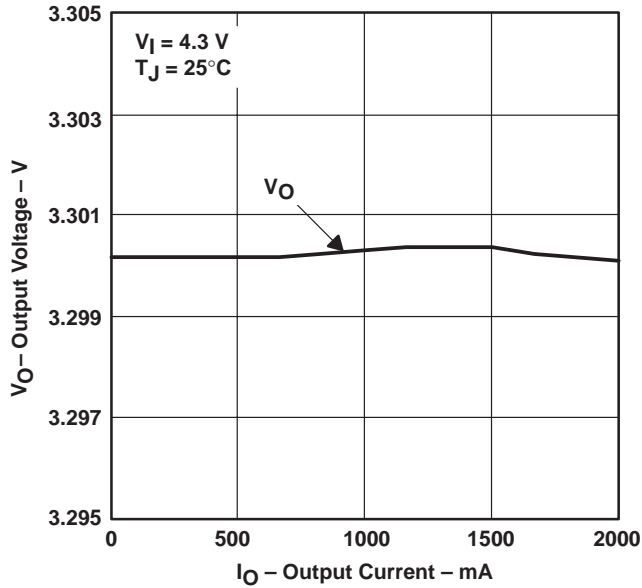

**Figure 2**

**TPS75x15Q  
 OUTPUT VOLTAGE  
 vs  
 OUTPUT CURRENT**

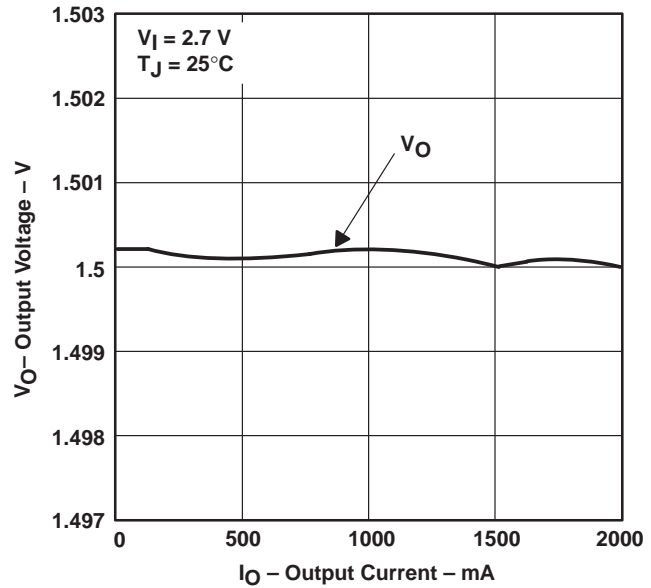

**Figure 3**

**TPS75x33Q  
 OUTPUT VOLTAGE  
 vs  
 JUNCTION TEMPERATURE**

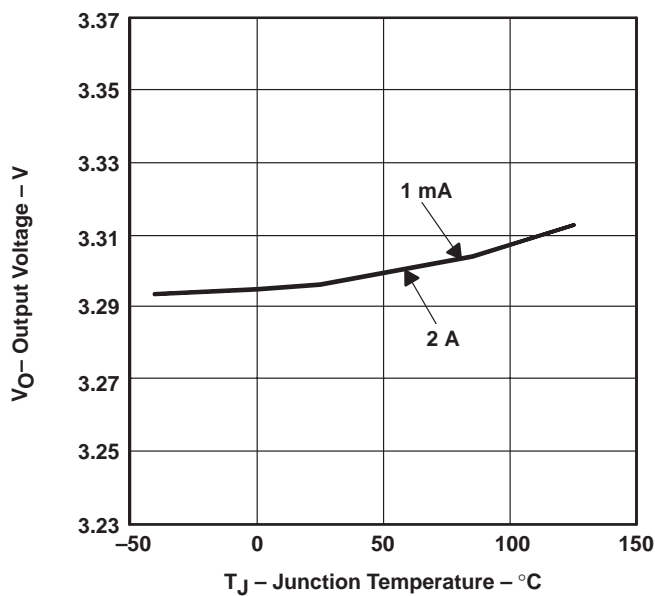

**Figure 4**

**TPS75x15Q  
 OUTPUT VOLTAGE  
 vs  
 JUNCTION TEMPERATURE**

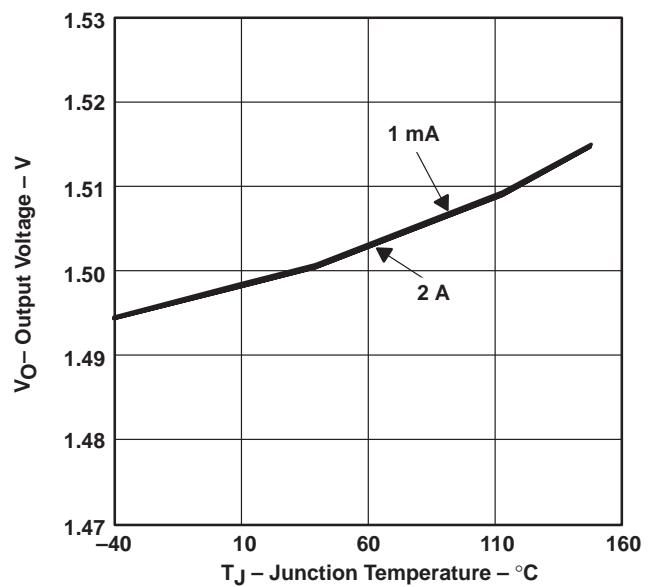

**Figure 5**



TYPICAL CHARACTERISTICS

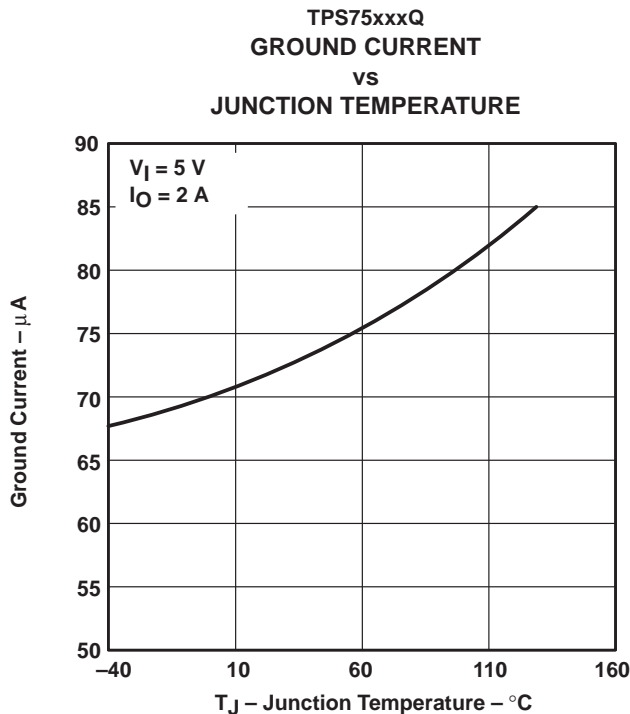

Figure 6

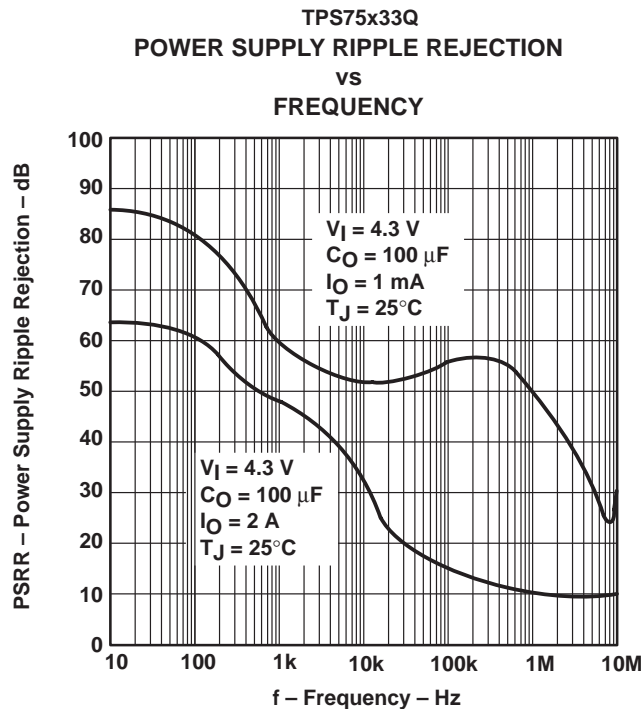

Figure 7

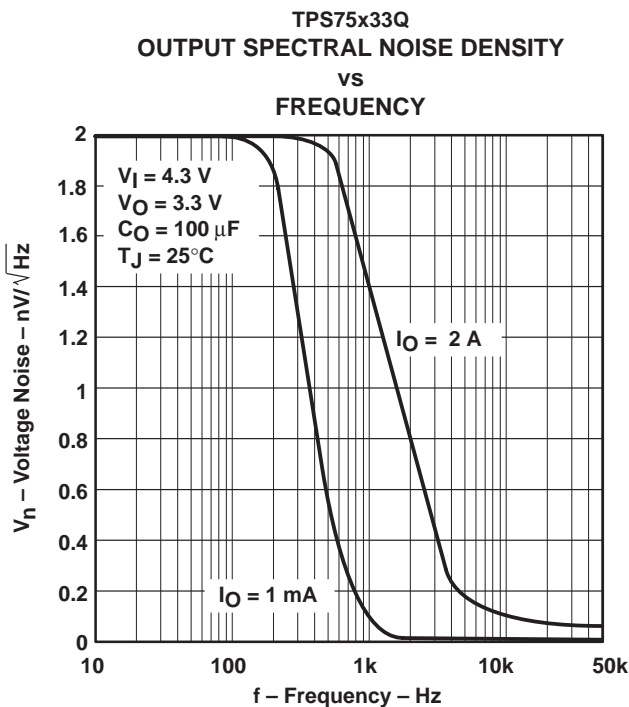

Figure 8

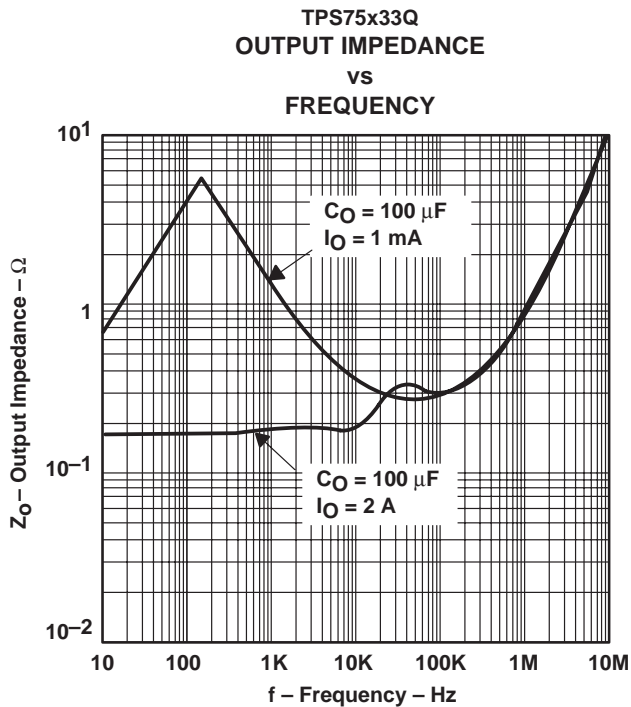
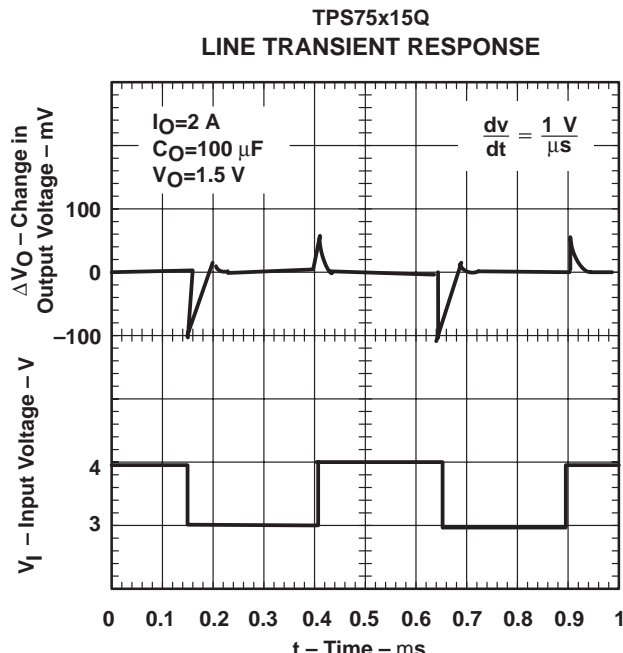
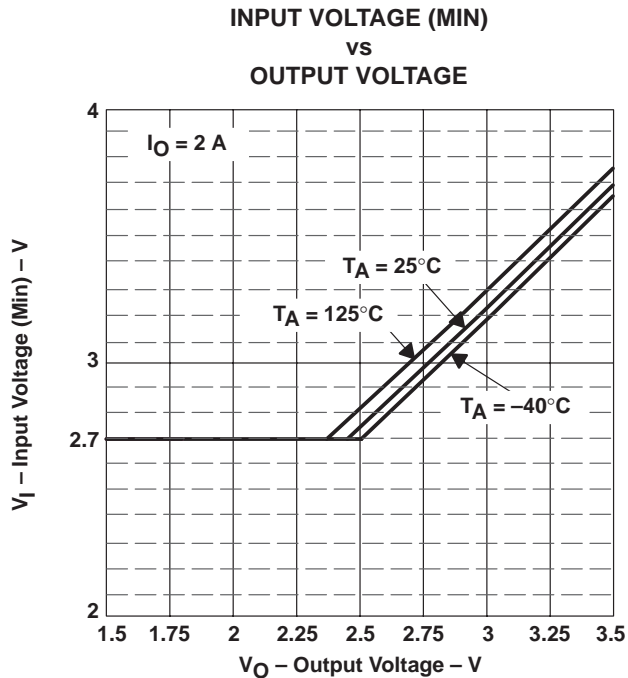
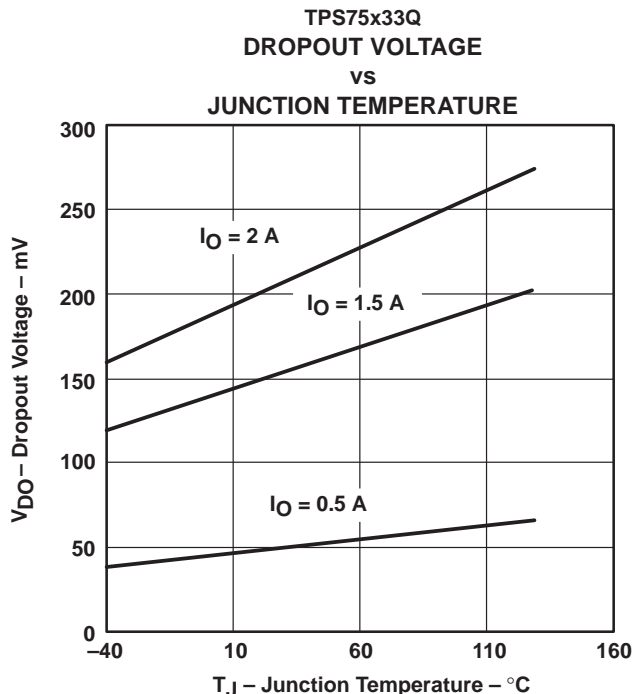
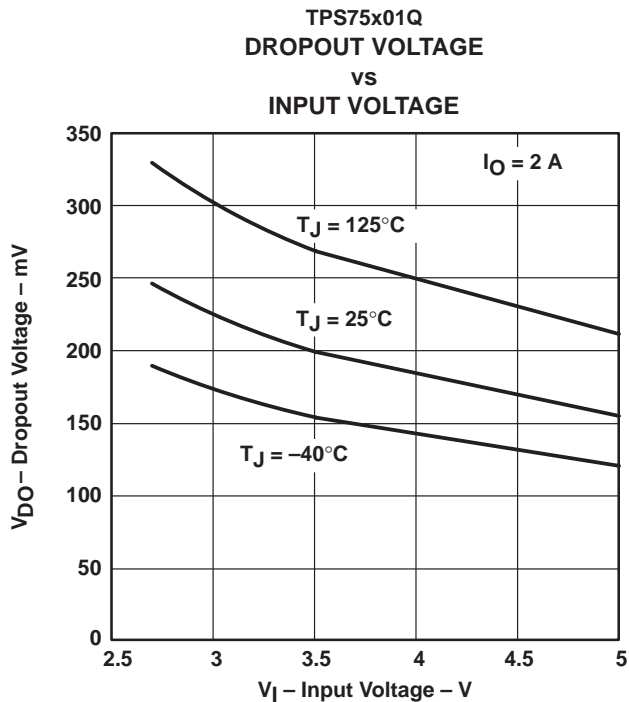
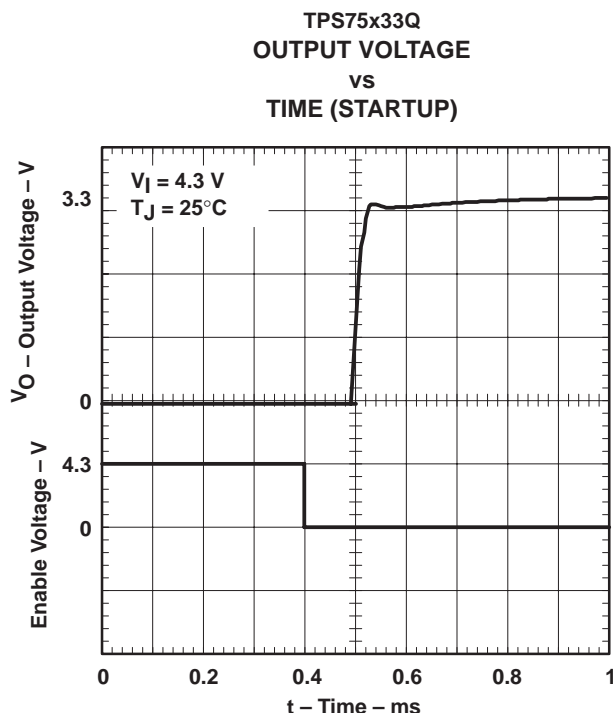
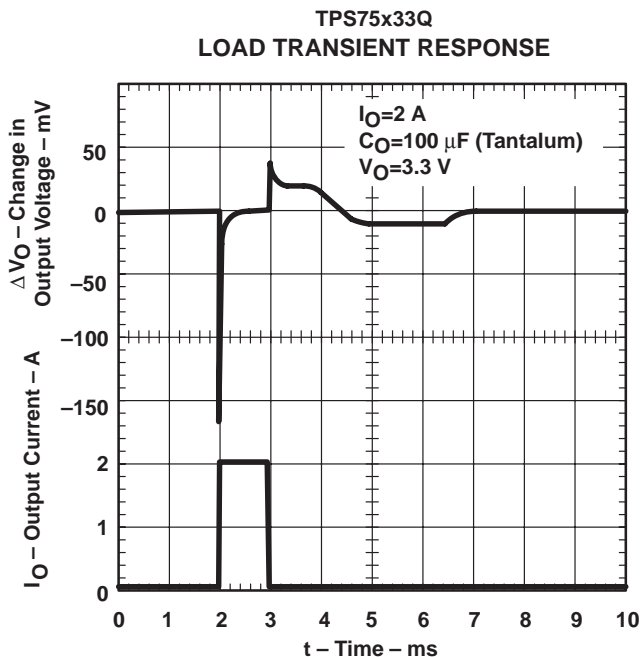
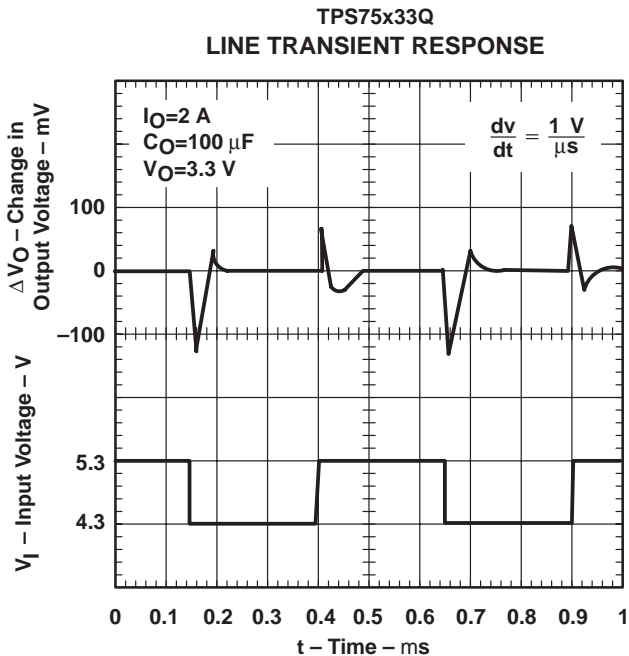
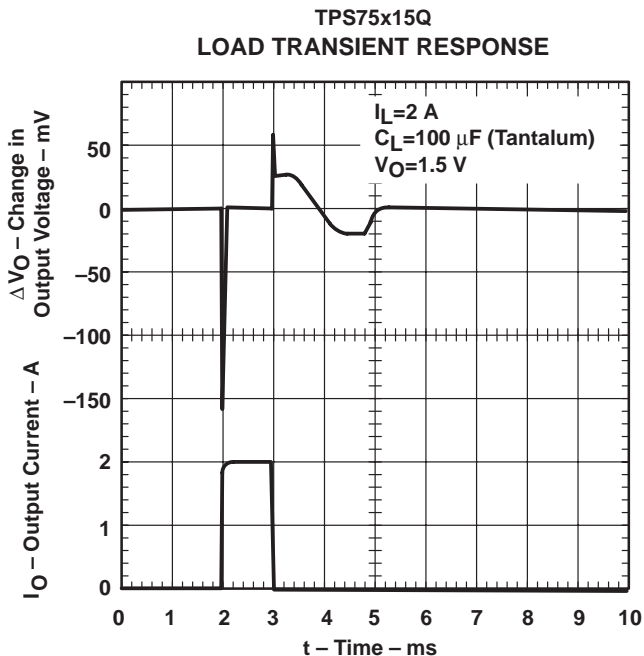

Figure 9

TYPICAL CHARACTERISTICS



TYPICAL CHARACTERISTICS



TYPICAL CHARACTERISTICS

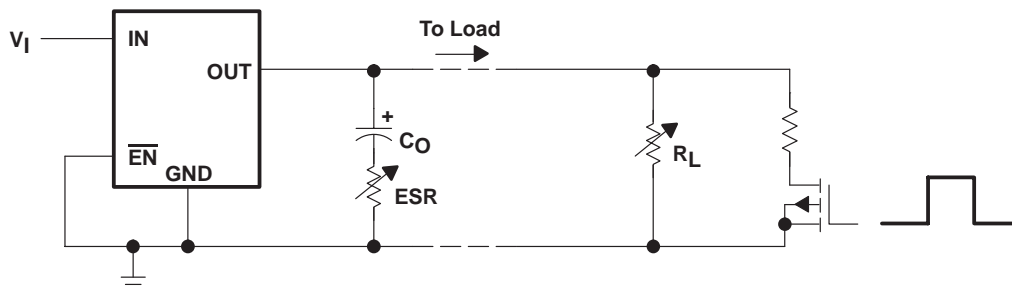

Figure 18. Test Circuit for Typical Regions of Stability (Figures 19 and 20) (Fixed Output Options)

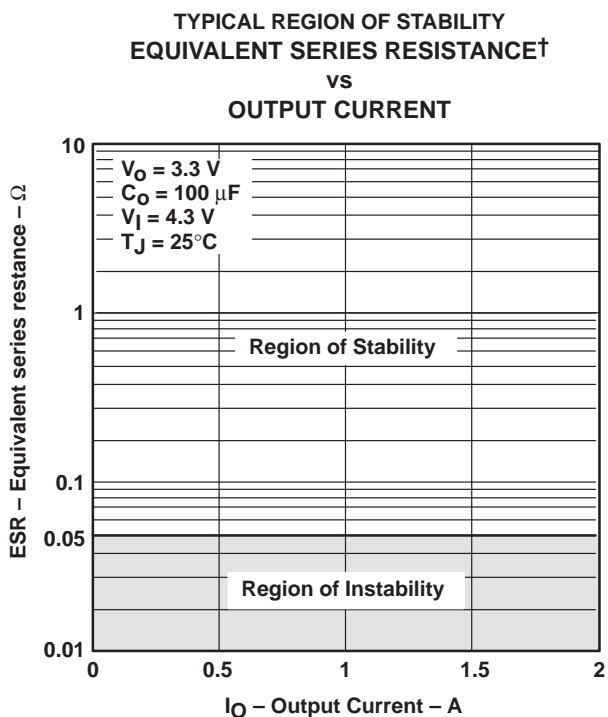

Figure 19

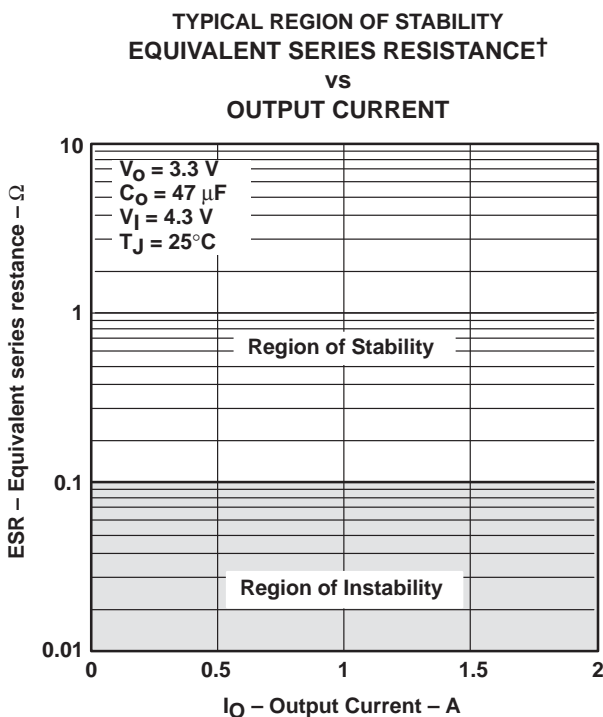

Figure 20

† Equivalent series resistance (ESR) refers to the total series resistance, including the ESR of the capacitor, any series resistance added externally, and PWB trace resistance to  $C_O$ .

## APPLICATION INFORMATION

The TPS752xxQ or TPS754xxQ families include four fixed-output voltage regulators (1.5 V, 1.8 V, 2.5 V and 3.3 V), and an adjustable regulator, the TPS75x01Q (adjustable from 1.5 V to 5 V).

### minimum load requirements

The TPS752xxQ and TPS754xxQ families are stable even at no load; no minimum load is required for operation.

### pin functions

#### enable ( $\overline{\text{EN}}$ )

The  $\overline{\text{EN}}$  terminal is an input which enables or shuts down the device. If  $\overline{\text{EN}}$  is a logic high, the device will be in shutdown mode. When  $\overline{\text{EN}}$  goes to logic low, then the device will be enabled.

#### power good (PG) (TPS754xxQ)

The PG terminal is an open drain, active high output that indicates the status of  $V_O$  (output of the LDO). When  $V_O$  reaches 83% of the regulated voltage, PG will go to a high impedance state. It will go to a low-impedance state when  $V_O$  falls below 83% (i.e. over load condition) of the regulated voltage. The open drain output of the PG terminal requires a pullup resistor.

#### sense (SENSE)

The SENSE terminal of the fixed-output options must be connected to the regulator output, and the connection should be as short as possible. Internally, SENSE connects to a high-impedance wide-bandwidth amplifier through a resistor-divider network and noise pickup feeds through to the regulator output. It is essential to route the SENSE connection in such a way to minimize/avoid noise pickup. Adding RC networks between the SENSE terminal and  $V_O$  to filter noise is not recommended because it may cause the regulator to oscillate.

#### feedback (FB)

FB is an input terminal used for the adjustable-output options and must be connected to an external feedback resistor divider. The FB connection should be as short as possible. It is essential to route it in such a way to minimize/avoid noise pickup. Adding RC networks between FB terminal and  $V_O$  to filter noise is not recommended because it may cause the regulator to oscillate.

#### reset ( $\overline{\text{RESET}}$ ) (TPS752xxQ)

The  $\overline{\text{RESET}}$  terminal is an open drain, active low output that indicates the status of  $V_O$ . When  $V_O$  reaches 95% of the regulated voltage,  $\overline{\text{RESET}}$  will go to a low-impedance state after a 100-ms delay.  $\overline{\text{RESET}}$  will go to a high-impedance state when  $V_O$  is below 95% of the regulated voltage. The open-drain output of the  $\overline{\text{RESET}}$  terminal requires a pullup resistor.

### GND/HEATSINK

All GND/HEATSINK terminals are connected directly to the mount pad for thermal-enhanced operation. These terminals could be connected to GND or left floating.

### input capacitor

For a typical application, an input bypass capacitor (0.22  $\mu\text{F}$  – 1  $\mu\text{F}$ ) is recommended for device stability. This capacitor should be as close to the input pins as possible. For fast transient condition where droop at the input of the LDO may occur due to high inrush current, it is recommended to place a larger capacitor at the input as well. The size of this capacitor is dependant on the output current and response time of the main power supply, as well as the distance to the load (LDO).

## APPLICATION INFORMATION

### output capacitor

As with most LDO regulators, the TPS752xxQ and TPS754xxQ require an output capacitor connected between OUT and GND to stabilize the internal control loop. The minimum recommended capacitance value is 47  $\mu\text{F}$  and the ESR (equivalent series resistance) must be between 100 m $\Omega$  and 10  $\Omega$ . Solid tantalum electrolytic, aluminum electrolytic, and multilayer ceramic capacitors are all suitable, provided they meet the requirements described in this section. Larger capacitors provide a wider range of stability and better load transient response.

This information, along with the ESR graphs, is included to assist in selection of suitable capacitance for the user's application. When necessary to achieve low height requirements along with high output current and/or high load capacitance, several higher ESR capacitors can be used in parallel to meet these guidelines.

### ESR and transient response

LDOs typically require an external output capacitor for stability. In fast transient response applications, capacitors are used to support the load current while LDO amplifier is responding. In most applications, one capacitor is used to support both functions.

Besides its capacitance, every capacitor also contains parasitic impedances. These parasitic impedances are resistive as well as inductive. The resistive impedance is called equivalent series resistance (ESR), and the inductive impedance is called equivalent series inductance (ESL). The equivalent schematic diagram of any capacitor can therefore be drawn as shown in Figure 21.



Figure 21. ESR and ESL



## APPLICATION INFORMATION

In most cases one can neglect the effect of inductive impedance ESL. Therefore, the following application focuses mainly on the parasitic resistance ESR.

Figure 22 shows the output capacitor and its parasitic impedances in a typical LDO output stage.

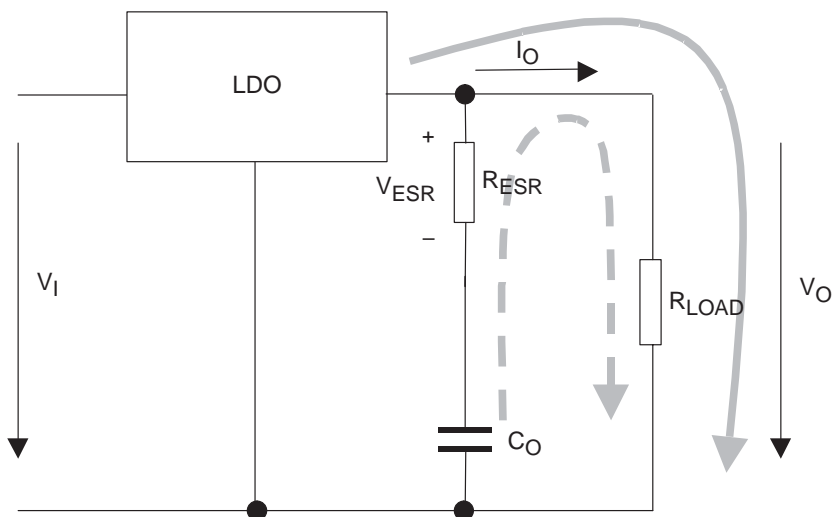

**Figure 22. LDO Output Stage With Parasitic Resistances ESR and ESL**

In steady state (dc state condition), the load current is supplied by the LDO (solid arrow) and the voltage across the capacitor is the same as the output voltage ( $V(C_O) = V_O$ ). This means no current is flowing into the  $C_O$  branch. If  $I_O$  suddenly increases (transient condition), the following occurs:

- The LDO is not able to supply the sudden current need due to its response time ( $t_1$  in Figure 24). Therefore, capacitor  $C_O$  provides the current for the new load condition (dashed arrow).  $C_O$  now acts like a battery with an internal resistance, ESR. Depending on the current demand at the output, a voltage drop will occur at  $R_{ESR}$ . This voltage is shown as  $V_{ESR}$  in Figure 23.
- When  $C_O$  is conducting current to the load, initial voltage at the load will be  $V_O = V(C_O) - V_{ESR}$ . Due to the discharge of  $C_O$ , the output voltage  $V_O$  will drop continuously until the response time  $t_1$  of the LDO is reached and the LDO will resume supplying the load. From this point, the output voltage starts rising again until it reaches the regulated voltage. This period is shown as  $t_2$  in Figure 24.

The figure also shows the impact of different ESRs on the output voltage. The left brackets show different levels of ESRs where number 1 displays the lowest and number 3 displays the highest ESR.

From above, the following conclusions can be drawn:

- The higher the ESR, the larger the droop at the beginning of load transient.
- The smaller the output capacitor, the faster the discharge time and the bigger the voltage droop during the LDO response period.

APPLICATION INFORMATION

conclusion

To minimize the transient output droop, capacitors must have a low ESR and be large enough to support the minimum output voltage requirement.

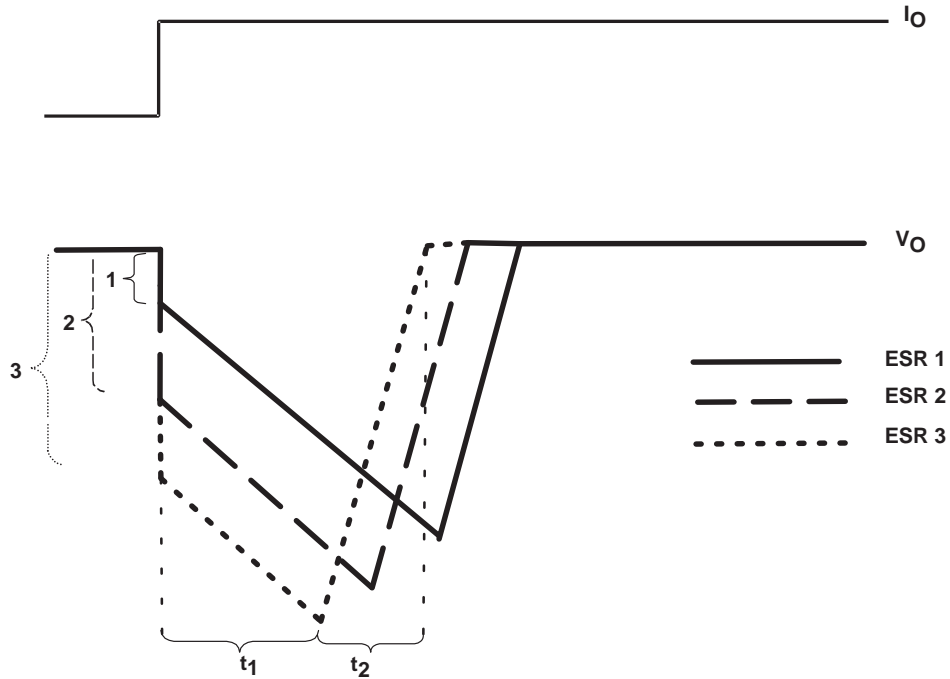

Figure 23. Correlation of Different ESRs and Their Influence to the Regulation of  $V_o$  at a Load Step From Low-to-High Output Current

## APPLICATION INFORMATION

### programming the TPS75x01Q adjustable LDO regulator

The output voltage of the TPS75x01Q adjustable regulator is programmed using an external resistor divider as shown in Figure 24. The output voltage is calculated using:

$$V_O = V_{\text{ref}} \times \left(1 + \frac{R1}{R2}\right) \quad (1)$$

Where:

$$V_{\text{ref}} = 1.1834 \text{ V typ (the internal reference voltage)}$$

Resistors R1 and R2 should be chosen for approximately 40- $\mu\text{A}$  divider current. Lower value resistors can be used but offer no inherent advantage and waste more power. Higher values should be avoided as leakage currents at FB increase the output voltage error. The recommended design procedure is to choose R2 = 30.1 k $\Omega$  to set the divider current at 40  $\mu\text{A}$  and then calculate R1 using:

$$R1 = \left(\frac{V_O}{V_{\text{ref}}} - 1\right) \times R2 \quad (2)$$

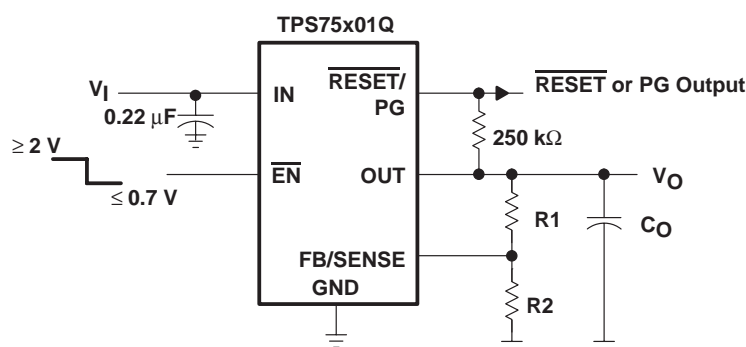

OUTPUT VOLTAGE  
PROGRAMMING GUIDE

OUTPUT VOLTAGE	R1	R2	UNIT
2.5 V	33.2	30.1	k $\Omega$
3.3 V	53.6	30.1	k $\Omega$
3.6 V	61.9	30.1	k $\Omega$

NOTE: To reduce noise and prevent oscillation, R1 and R2 need to be as close as possible to the FB/SENSE terminal.

Figure 24. TPS75x01Q Adjustable LDO Regulator Programming

## APPLICATION INFORMATION

### regulator protection

The TPS752xxQ and TPS754xxQ PMOS-pass transistors has a built-in back diode that conducts reverse currents when the input voltage drops below the output voltage (e.g., during power down). Current is conducted from the output to the input and is not internally limited. When extended reverse voltage is anticipated, external limiting may be appropriate.

The TPS752xxQ and TPS754xxQ also feature internal current limiting and thermal protection. During normal operation, the TPS752xxQ and TPS754xxQ limit output current to approximately 3.3 A. When current limiting engages, the output voltage scales back linearly until the overcurrent condition ends. While current limiting is designed to prevent gross device failure, care should be taken not to exceed the power dissipation ratings of the package. If the temperature of the device exceeds 150°C(typ), thermal-protection circuitry shuts it down. Once the device has cooled below 130°C(typ), regulator operation resumes.

### power dissipation and junction temperature

Specified regulator operation is assured to a junction temperature of 125°C; the maximum junction temperature should be restricted to 125°C under normal operating conditions. This restriction limits the power dissipation the regulator can handle in any given application. To ensure the junction temperature is within acceptable limits, calculate the maximum allowable dissipation,  $P_{D(max)}$ , and the actual dissipation,  $P_D$ , which must be less than or equal to  $P_{D(max)}$ .

The maximum-power-dissipation limit is determined using the following equation:

$$P_{D(max)} = \frac{T_{Jmax} - T_A}{R_{\theta JA}} \quad (3)$$

Where:

$T_{Jmax}$  is the maximum allowable junction temperature

$R_{\theta JA}$  is the thermal resistance junction-to-ambient for the package, i.e., 34.6°C/W for the 20-terminal PWP with no airflow (see Table 1).

$T_A$  is the ambient temperature.

The regulator dissipation is calculated using:

$$P_D = (V_I - V_O) \times I_O \quad (4)$$

Power dissipation resulting from quiescent current is negligible. Excessive power dissipation will trigger the thermal protection circuit.

## THERMAL INFORMATION

### thermally enhanced TSSOP-20 (PWP – PowerPad™)

The thermally enhanced PWP package is based on the 20-pin TSSOP, but includes a thermal pad [see Figure 25(c)] to provide an effective thermal contact between the IC and the PWB.

Traditionally, surface mount and power have been mutually exclusive terms. A variety of scaled-down TO220-type packages have leads formed as gull wings to make them applicable for surface-mount applications. These packages, however, suffer from several shortcomings: they do not address the very low profile requirements (<2 mm) of many of today's advanced systems, and they do not offer a pin-count high enough to accommodate increasing integration. On the other hand, traditional low-power surface-mount packages require power-dissipation derating that severely limits the usable range of many high-performance analog circuits.

The PWP package (thermally enhanced TSSOP) combines fine-pitch surface-mount technology with thermal performance comparable to much larger power packages.

The PWP package is designed to optimize the heat transfer to the PWB. Because of the very small size and limited mass of a TSSOP package, thermal enhancement is achieved by improving the thermal conduction paths that remove heat from the component. The thermal pad is formed using a lead-frame design (patent pending) and manufacturing technique to provide the user with direct connection to the heat-generating IC. When this pad is soldered or otherwise coupled to an external heat dissipator, high power dissipation in the ultrathin, fine-pitch, surface-mount package can be reliably achieved.

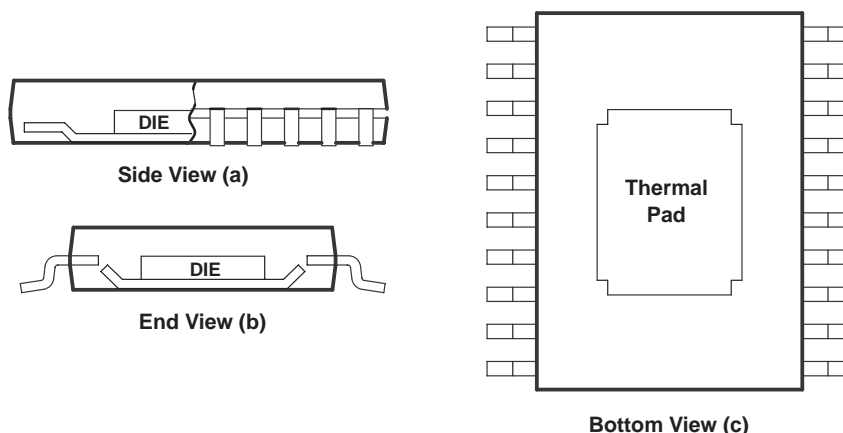

**Figure 25. Views of Thermally Enhanced PWP Package**

Because the conduction path has been enhanced, power-dissipation capability is determined by the thermal considerations in the PWB design. For example, simply adding a localized copper plane (heat-sink surface), which is coupled to the thermal pad, enables the PWP package to dissipate 2.5 W in free air (reference Figure 27(a), 8 cm<sup>2</sup> of copper heat sink and natural convection). Increasing the heat-sink size increases the power dissipation range for the component. The power dissipation limit can be further improved by adding airflow to a PWB/IC assembly (see Figures 26 and 27). The line drawn at 0.3 cm<sup>2</sup> in Figures 26 and 27 indicates performance at the minimum recommended heat-sink size, illustrated in Figure 29.

THERMAL INFORMATION

thermally enhanced TSSOP-20 (PWP – PowerPad™) (continued)

The thermal pad is directly connected to the substrate of the IC, which for the TPS752xxQPWP and TPS754xxQPWP series is a secondary electrical connection to device ground. The heat-sink surface that is added to the PWP can be a ground plane or left electrically isolated. In TO220-type surface-mount packages, the thermal connection is also the primary electrical connection for a given terminal which is not always ground. The PWP package provides up to 16 independent leads that can be used as inputs and outputs (Note: leads 1, 10, 11, and 20 are internally connected to the thermal pad and the IC substrate).

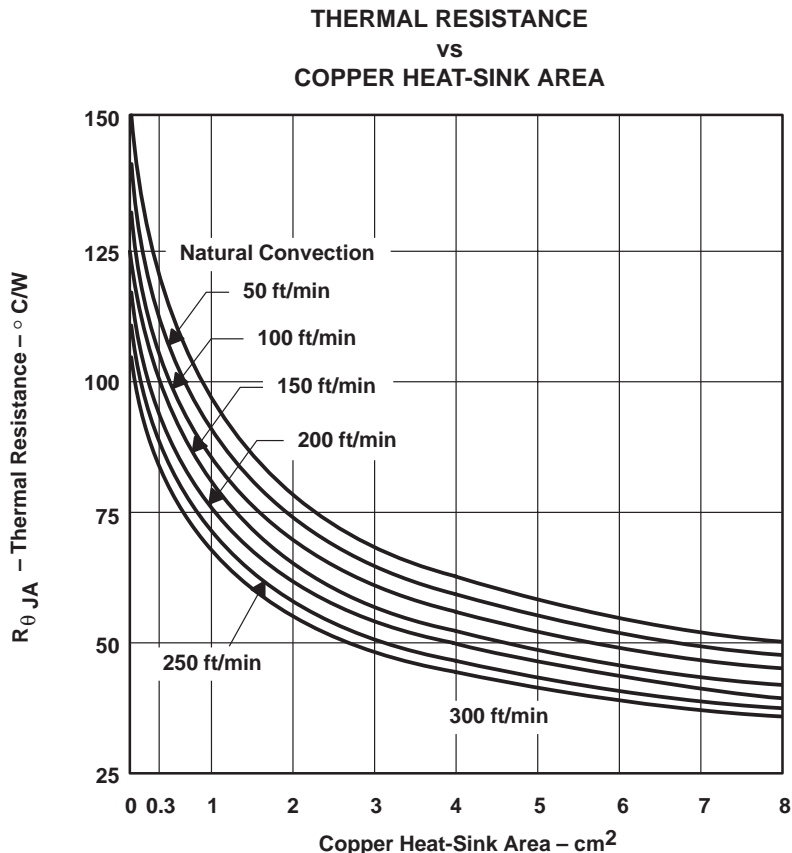

Figure 26

THERMAL INFORMATION

thermally enhanced TSSOP-20 (PWP – PowerPad™) (continued)

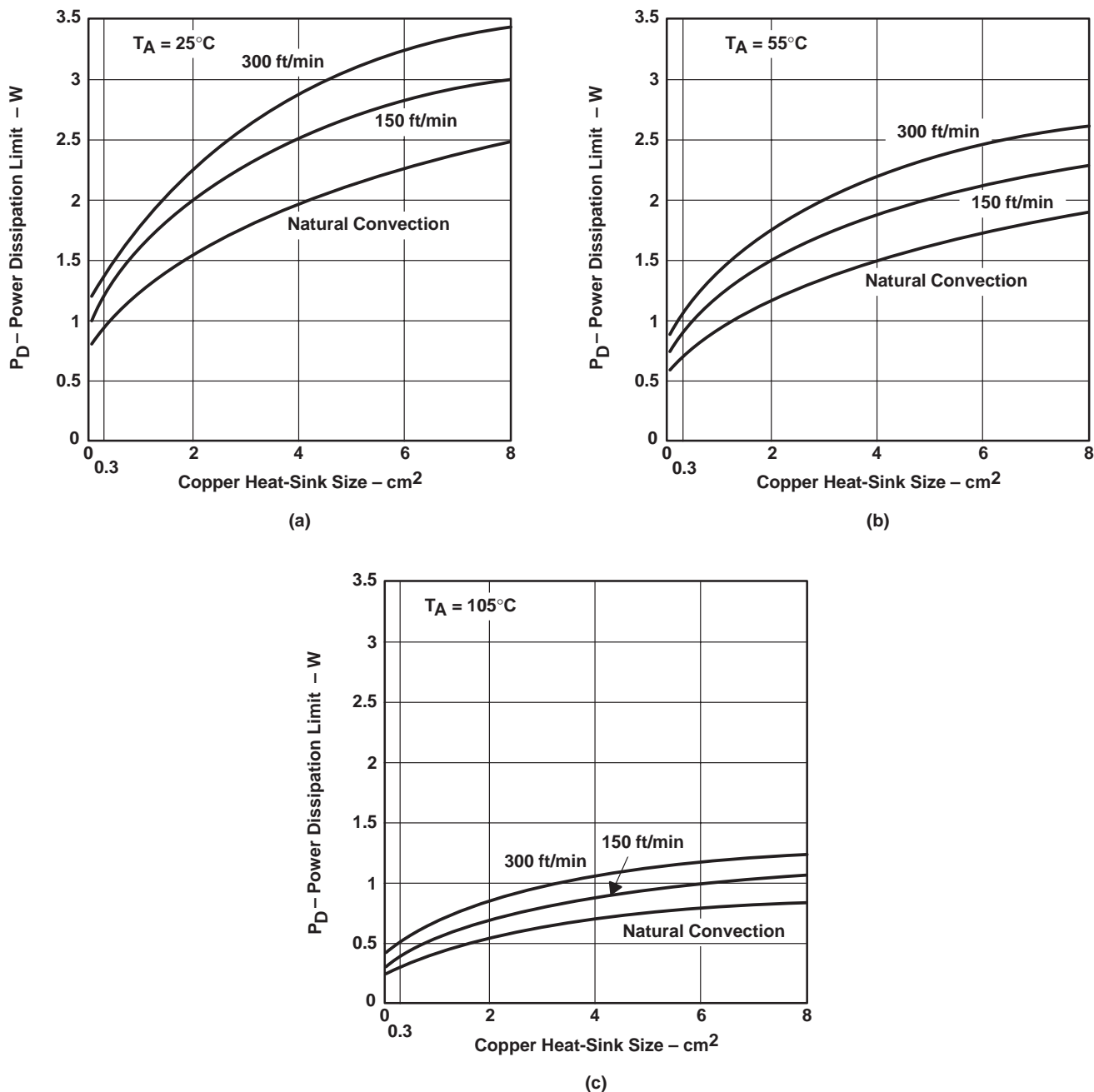
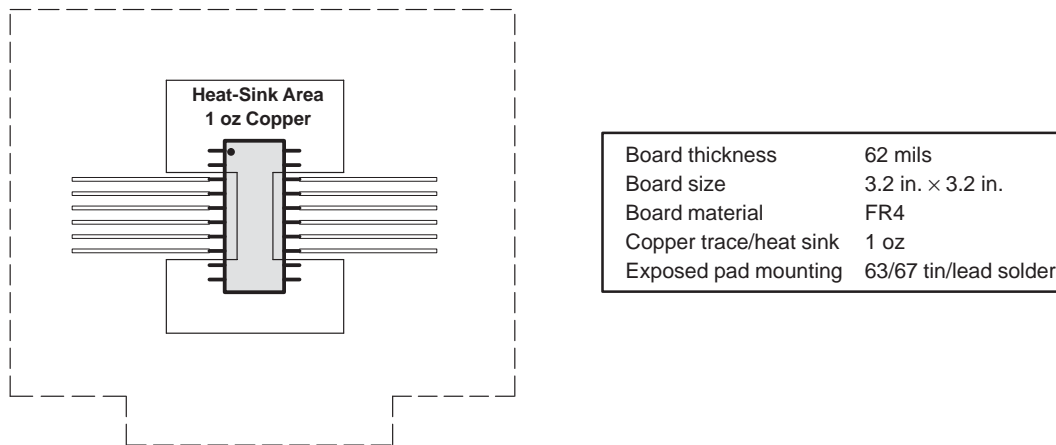

Figure 27. Power Ratings of the PWP Package at Ambient Temperatures of 25°C, 55°C, and 105°C

**THERMAL INFORMATION**

**thermally enhanced TSSOP-20 (PWP – PowerPad™) (continued)**

Figure 28 is an example of a thermally enhanced PWB layout for use with the new PWP package. This board configuration was used in the thermal experiments that generated the power ratings shown in Figure 26 and Figure 27. As discussed earlier, copper has been added on the PWB to conduct heat away from the device.  $R_{\theta JA}$  for this assembly is illustrated in Figure 26 as a function of heat-sink area. A family of curves is included to illustrate the effect of airflow introduced into the system.



**Figure 28. PWB Layout (Including Copper Heatsink Area) for Thermally Enhanced PWP Package**

From Figure 26,  $R_{\theta JA}$  for a PWB assembly can be determined and used to calculate the maximum power-dissipation limit for the component/PWB assembly, with the equation:

$$P_{D(max)} = \frac{T_{Jmax} - T_A}{R_{\theta JA(system)}} \tag{5}$$

Where:

$T_{Jmax}$  is the maximum specified junction temperature (150°C absolute maximum limit, 125°C recommended operating limit) and  $T_A$  is the ambient temperature.

$P_{D(max)}$  should then be applied to the internal power dissipated by the TPS75233QPWP regulator. The equation for calculating total internal power dissipation of the TPS75233QPWP is:

$$P_{D(total)} = (V_I - V_O) \times I_O + V_I \times I_Q \tag{6}$$

Since the quiescent current of the TPS75233QPWP is very low, the second term is negligible, further simplifying the equation to:

$$P_{D(total)} = (V_I - V_O) \times I_O \tag{7}$$

For the case where  $T_A = 55^\circ\text{C}$ , airflow = 200 ft/min, copper heat-sink area = 4 cm<sup>2</sup>, the maximum power-dissipation limit can be calculated. First, from Figure 26, we find the system  $R_{\theta JA}$  is 50°C/W; therefore, the maximum power-dissipation limit is:

$$P_{D(max)} = \frac{T_{Jmax} - T_A}{R_{\theta JA(system)}} = \frac{125^\circ\text{C} - 55^\circ\text{C}}{50^\circ\text{C/W}} = 1.4 \text{ W} \tag{8}$$



## THERMAL INFORMATION

### thermally enhanced TSSOP-20 (PWP – PowerPad™) (continued)

If the system implements a TPS75233QPWP regulator, where  $V_I = 5\text{ V}$  and  $I_O = 800\text{ mA}$ , the internal power dissipation is:

$$P_{D(\text{total})} = (V_I - V_O) \times I_O = (5 - 3.3) \times 0.8 = 1.36\text{ W} \quad (9)$$

Comparing  $P_{D(\text{total})}$  with  $P_{D(\text{max})}$  reveals that the power dissipation in this example does not exceed the calculated limit. When it does, one of two corrective actions should be made: raising the power-dissipation limit by increasing the airflow or the heat-sink area, or lowering the internal power dissipation of the regulator by reducing the input voltage or the load current. In either case, the above calculations should be repeated with the new system parameters.

### mounting information

The primary requirement is to complete the thermal contact between the thermal pad and the PWB metal. The thermal pad is a solderable surface and is fully intended to be soldered at the time the component is mounted. Although voiding in the thermal-pad solder-connection is not desirable, up to 50% voiding is acceptable. The data included in Figures 26 and 27 is for soldered connections with voiding between 20% and 50%. The thermal analysis shows no significant difference resulting from the variation in voiding percentage.

Figure 29 shows the solder-mask land pattern for the PWP package. The minimum recommended heat-sink area is also illustrated. This is simply a copper plane under the body extent of the package, including metal routed under terminals 1, 10, 11, and 20.

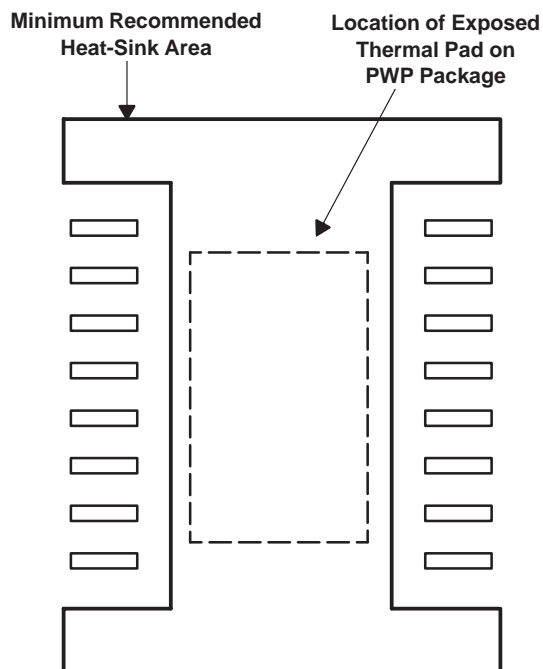

Figure 29. PWP Package Land Pattern

**PACKAGING INFORMATION**

Orderable Device	Status <sup>(1)</sup>	Package Type	Package Drawing	Pins	Package Qty	Eco Plan <sup>(2)</sup>	Lead/Ball Finish	MSL Peak Temp <sup>(3)</sup>
TPS75201QPWP	ACTIVE	HTSSOP	PWP	20	70	None	CU NIPDAU	Level-1-220C-UNLIM
TPS75201QPWPR	ACTIVE	HTSSOP	PWP	20	2000	None	CU NIPDAU	Level-1-220C-UNLIM
TPS75215QPWP	ACTIVE	HTSSOP	PWP	20	70	None	CU NIPDAU	Level-1-220C-UNLIM
TPS75215QPWPR	ACTIVE	HTSSOP	PWP	20	2000	None	CU NIPDAU	Level-1-220C-UNLIM
TPS75218QPWP	ACTIVE	HTSSOP	PWP	20	70	None	CU NIPDAU	Level-1-220C-UNLIM
TPS75218QPWPR	ACTIVE	HTSSOP	PWP	20	2000	None	CU NIPDAU	Level-1-220C-UNLIM
TPS75225QPWP	ACTIVE	HTSSOP	PWP	20	70	None	CU NIPDAU	Level-1-220C-UNLIM
TPS75225QPWPR	ACTIVE	HTSSOP	PWP	20	2000	None	CU NIPDAU	Level-1-220C-UNLIM
TPS75233QPWP	ACTIVE	HTSSOP	PWP	20	70	None	CU NIPDAU	Level-1-220C-UNLIM
TPS75233QPWPR	ACTIVE	HTSSOP	PWP	20	2000	None	CU NIPDAU	Level-1-220C-UNLIM
TPS75401QPWP	ACTIVE	HTSSOP	PWP	20	70	None	CU NIPDAU	Level-1-220C-UNLIM
TPS75401QPWPR	ACTIVE	HTSSOP	PWP	20	2000	None	CU NIPDAU	Level-1-220C-UNLIM
TPS75415QPWP	ACTIVE	HTSSOP	PWP	20	70	None	CU NIPDAU	Level-1-220C-UNLIM
TPS75415QPWPR	ACTIVE	HTSSOP	PWP	20	2000	None	CU NIPDAU	Level-1-220C-UNLIM
TPS75418QPWP	ACTIVE	HTSSOP	PWP	20	70	None	CU NIPDAU	Level-1-220C-UNLIM
TPS75418QPWPR	ACTIVE	HTSSOP	PWP	20	2000	None	CU NIPDAU	Level-1-220C-UNLIM
TPS75418QPWPRG4	ACTIVE	HTSSOP	PWP	20	2000	Green (RoHS & no Sb/Br)	CU NIPDAU	Level-2-260C-1 YEAR
TPS75425QPWP	ACTIVE	HTSSOP	PWP	20	70	None	CU NIPDAU	Level-1-220C-UNLIM
TPS75425QPWPR	ACTIVE	HTSSOP	PWP	20	2000	None	CU NIPDAU	Level-1-220C-UNLIM
TPS75433QPWP	ACTIVE	HTSSOP	PWP	20	70	None	CU NIPDAU	Level-1-220C-UNLIM
TPS75433QPWPR	ACTIVE	HTSSOP	PWP	20	2000	None	CU NIPDAU	Level-1-220C-UNLIM

<sup>(1)</sup> The marketing status values are defined as follows:

**ACTIVE:** Product device recommended for new designs.

**LIFEBUY:** TI has announced that the device will be discontinued, and a lifetime-buy period is in effect.

**NRND:** Not recommended for new designs. Device is in production to support existing customers, but TI does not recommend using this part in a new design.

**PREVIEW:** Device has been announced but is not in production. Samples may or may not be available.

**OBSOLETE:** TI has discontinued the production of the device.

<sup>(2)</sup> Eco Plan - May not be currently available - please check <http://www.ti.com/productcontent> for the latest availability information and additional product content details.

**None:** Not yet available Lead (Pb-Free).

**Pb-Free (RoHS):** TI's terms "Lead-Free" or "Pb-Free" mean semiconductor products that are compatible with the current RoHS requirements for all 6 substances, including the requirement that lead not exceed 0.1% by weight in homogeneous materials. Where designed to be soldered at high temperatures, TI Pb-Free products are suitable for use in specified lead-free processes.

**Green (RoHS & no Sb/Br):** TI defines "Green" to mean "Pb-Free" and in addition, uses package materials that do not contain halogens, including bromine (Br) or antimony (Sb) above 0.1% of total product weight.

<sup>(3)</sup> MSL, Peak Temp. -- The Moisture Sensitivity Level rating according to the JEDEC industry standard classifications, and peak solder temperature.

**Important Information and Disclaimer:** The information provided on this page represents TI's knowledge and belief as of the date that it is provided. TI bases its knowledge and belief on information provided by third parties, and makes no representation or warranty as to the accuracy of such information. Efforts are underway to better integrate information from third parties. TI has taken and continues to take reasonable steps to provide representative and accurate information but may not have conducted destructive testing or chemical analysis on incoming materials and chemicals. TI and TI suppliers consider certain information to be proprietary, and thus CAS numbers and other limited information may not be available for release.

In no event shall TI's liability arising out of such information exceed the total purchase price of the TI part(s) at issue in this document sold by TI to Customer on an annual basis.

PWP (R-PDSO-G\*\*) 20 PIN SHOWN

PowerPAD™ PLASTIC SMALL-OUTLINE PACKAGE

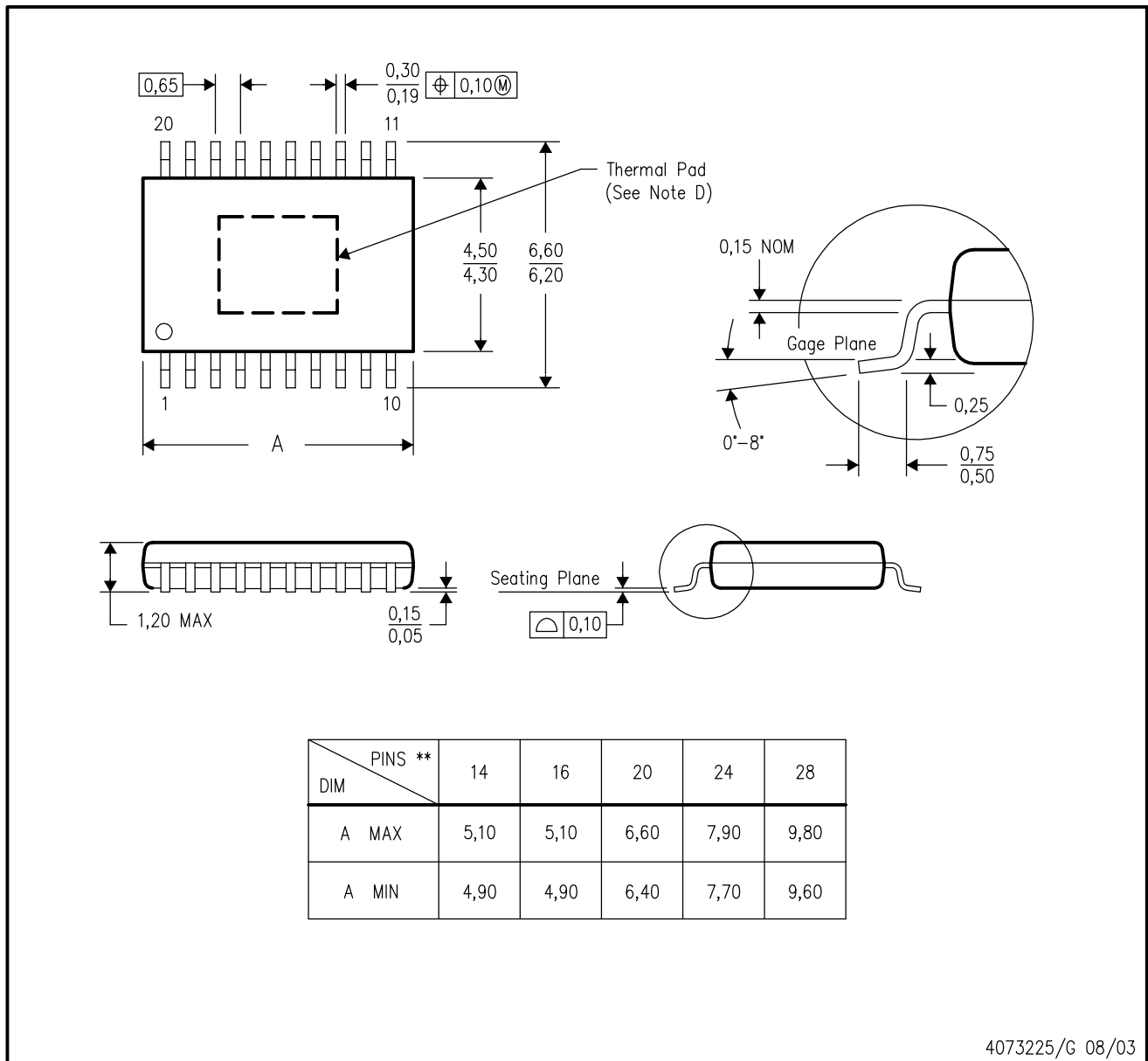

4073225/G 08/03

- NOTES:
- A. All linear dimensions are in millimeters.
  - B. This drawing is subject to change without notice.
  - C. Body dimensions do not include mold flash or protrusions.
  - D. This package is designed to be soldered to a thermal pad on the board. Refer to Technical Brief, PowerPad Thermally Enhanced Package, Texas Instruments Literature No. SLMA002 for information regarding recommended board layout. This document is available at [www.ti.com](http://www.ti.com) <<http://www.ti.com>>.
  - E. Falls within JEDEC MO-153

PowerPAD is a trademark of Texas Instruments.

## IMPORTANT NOTICE

Texas Instruments Incorporated and its subsidiaries (TI) reserve the right to make corrections, modifications, enhancements, improvements, and other changes to its products and services at any time and to discontinue any product or service without notice. Customers should obtain the latest relevant information before placing orders and should verify that such information is current and complete. All products are sold subject to TI's terms and conditions of sale supplied at the time of order acknowledgment.

TI warrants performance of its hardware products to the specifications applicable at the time of sale in accordance with TI's standard warranty. Testing and other quality control techniques are used to the extent TI deems necessary to support this warranty. Except where mandated by government requirements, testing of all parameters of each product is not necessarily performed.

TI assumes no liability for applications assistance or customer product design. Customers are responsible for their products and applications using TI components. To minimize the risks associated with customer products and applications, customers should provide adequate design and operating safeguards.

TI does not warrant or represent that any license, either express or implied, is granted under any TI patent right, copyright, mask work right, or other TI intellectual property right relating to any combination, machine, or process in which TI products or services are used. Information published by TI regarding third-party products or services does not constitute a license from TI to use such products or services or a warranty or endorsement thereof. Use of such information may require a license from a third party under the patents or other intellectual property of the third party, or a license from TI under the patents or other intellectual property of TI.

Reproduction of information in TI data books or data sheets is permissible only if reproduction is without alteration and is accompanied by all associated warranties, conditions, limitations, and notices. Reproduction of this information with alteration is an unfair and deceptive business practice. TI is not responsible or liable for such altered documentation.

Resale of TI products or services with statements different from or beyond the parameters stated by TI for that product or service voids all express and any implied warranties for the associated TI product or service and is an unfair and deceptive business practice. TI is not responsible or liable for any such statements.

Following are URLs where you can obtain information on other Texas Instruments products and application solutions:

<b>Products</b>		<b>Applications</b>	
Amplifiers	<a href="http://amplifier.ti.com">amplifier.ti.com</a>	Audio	<a href="http://www.ti.com/audio">www.ti.com/audio</a>
Data Converters	<a href="http://dataconverter.ti.com">dataconverter.ti.com</a>	Automotive	<a href="http://www.ti.com/automotive">www.ti.com/automotive</a>
DSP	<a href="http://dsp.ti.com">dsp.ti.com</a>	Broadband	<a href="http://www.ti.com/broadband">www.ti.com/broadband</a>
Interface	<a href="http://interface.ti.com">interface.ti.com</a>	Digital Control	<a href="http://www.ti.com/digitalcontrol">www.ti.com/digitalcontrol</a>
Logic	<a href="http://logic.ti.com">logic.ti.com</a>	Military	<a href="http://www.ti.com/military">www.ti.com/military</a>
Power Mgmt	<a href="http://power.ti.com">power.ti.com</a>	Optical Networking	<a href="http://www.ti.com/opticalnetwork">www.ti.com/opticalnetwork</a>
Microcontrollers	<a href="http://microcontroller.ti.com">microcontroller.ti.com</a>	Security	<a href="http://www.ti.com/security">www.ti.com/security</a>
		Telephony	<a href="http://www.ti.com/telephony">www.ti.com/telephony</a>
		Video & Imaging	<a href="http://www.ti.com/video">www.ti.com/video</a>
		Wireless	<a href="http://www.ti.com/wireless">www.ti.com/wireless</a>

Mailing Address: Texas Instruments  
Post Office Box 655303 Dallas, Texas 75265