

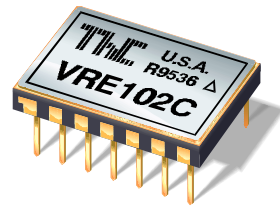

# VRE100/101/102

## Precision Reference Supplies



THALER CORPORATION • 2015 N. FORBES BOULEVARD • TUCSON, AZ. 85745 • (520) 882-4000

### FEATURES

- **VERY HIGH ACCURACY:** 10.000 V OUTPUT  $\pm 0.5$  mV
- **EXTREMELY LOW DRIFT:** 0.5 ppm/ $^{\circ}$ C 55 $^{\circ}$ C to +125 $^{\circ}$ C
- **LOW WARM-UP DRIFT:** 1.0 ppm Typ.
- **EXCELLENT STABILITY:** 6 ppm/1000 Hrs. Typ.
- **EXCELLENT LINE REGULATION:** 3 ppm/V Typ.
- **HERMETIC 14-PIN CERAMIC DIP**
- **MILITARY PROCESSING OPTION**
- **PIN & FUNCTION COMPATIBLE WITH AD2700, AD2710 Series**

### APPLICATIONS

- **PRECISION A/D and D/A CONVERTERS**
- **TRANSDUCER EXCITATION**
- **ACCURATE COMPARATOR THRESHOLD REFERENCE**
- **HIGH RESOLUTION SERVO SYSTEMS**
- **DIGITAL VOLTMETERS**
- **HIGH PRECISION TEST and MEASUREMENT INSTRUMENTS**

### DESCRIPTION

VRE100 Series Precision Voltage References provide ultrastable +10.000V (VRE100), -10.000V (VRE101) and  $\pm 10.000$ V (VRE102) outputs with  $\pm 0.5$  mV initial accuracy and temperature coefficient as low as 0.5 ppm/ $^{\circ}$ C over the full military temperature range. This improvement in accuracy is made possible by a unique, proprietary multipoint laser compensation technique developed by Thaler Corporation.

Significant improvements have been made in other performance parameters as well, including initial accuracy, warm-up drift, line regulation, and long-term stability, making the VRE100 series the most accurate and stable 10V reference available.

VRE100/101/102 devices are available in two operating temperature ranges, -25 $^{\circ}$ C to +85 $^{\circ}$ C and -55 $^{\circ}$ C to +125 $^{\circ}$ C, and two performance grades. All devices are packaged in 14-pin hermetic ceramic packages for maximum long-term stability. "M" versions are screened for high reliability and quality.

Superior stability, accuracy, and quality make these references ideal for precision applications such as A/D and D/A converters, high-accuracy test and measurement instrumentation, and transducer excitation.

### SELECTION GUIDE

Type	Output	Temperature Operating Range	Max. Volt Deviation
VRE100C	+10V	-25 $^{\circ}$ C to +85 $^{\circ}$ C	0.6mV
VRE100CA	+10V	-25 $^{\circ}$ C to +85 $^{\circ}$ C	0.3mV
VRE100M	+10V	-55 $^{\circ}$ C to +125 $^{\circ}$ C	1.0mV
VRE100MA	+10V	-55 $^{\circ}$ C to +125 $^{\circ}$ C	0.5mV
VRE101C	-10V	-25 $^{\circ}$ C to +85 $^{\circ}$ C	0.6mV
VRE101CA	-10V	-25 $^{\circ}$ C to +85 $^{\circ}$ C	0.3mV
VRE101M	-10V	-55 $^{\circ}$ C to +125 $^{\circ}$ C	1.0mV
VRE101MA	-10V	-55 $^{\circ}$ C to +125 $^{\circ}$ C	0.5mV
VRE102C	$\pm 10$ V	-25 $^{\circ}$ C to +85 $^{\circ}$ C	0.6mV
VRE102CA	$\pm 10$ V	-25 $^{\circ}$ C to +85 $^{\circ}$ C	0.3mV
VRE102M	$\pm 10$ V	-55 $^{\circ}$ C to +125 $^{\circ}$ C	1.0mV
VRE102MA	$\pm 10$ V	-55 $^{\circ}$ C to +125 $^{\circ}$ C	0.5mV

# ELECTRICAL SPECIFICATIONS

# VRE100/101/102

Vps = ±15V, T = 25°C, RL = 10KΩ unless otherwise noted.

MODEL	C			CA			M			MA			
PARAMETERS	MIN	TYP	MAX	MIN	TYP	MAX	MIN	TYP	MAX	MIN	TYP	MAX	UNITS
<b>ABSOLUTE MAXIMUM RATINGS</b>													
Power Supply	±13.5		±22	*		*	*		*	*		*	V
Operating Temperature	-25		85	*		*	-55		125	-55		125	°C
Storage Temperature	-65		150	*		*	*		*	*		*	°C
Short Circuit Protection	Continuous				*			*			*		
<b>OUTPUT VOLTAGE</b>													
VRE100		+10			*			*			*		V
VRE101		-10			*			*			*		V
VRE102		±10			*			*			*		V
<b>OUTPUT VOLTAGE ERRORS</b>													
Initial Error			1.0			0.5			1.5			0.8	mV
Warmup Drift		2			1			2			1		ppm
T <sub>min</sub> - T <sub>max</sub> <sup>(1)</sup>			0.6			0.3			1.0			0.5	mV
Long-Term Stability		6			*			*			*		ppm/1000hr.
Noise (.1-10Hz)		6			*			*			*		μVpp
<b>OUTPUT CURRENT</b>													
Range	±10			*			*			*			mA
<b>REGULATION</b>													
Line		3	10		*	*		*	*		*	*	ppm/V
Load		3			*			*			*		ppm/mA
<b>OUTPUT ADJUSTMENT</b>													
Range		20			*			*			*		mV
Temperature Coefficient		4			*			*			*		μV/°C/mV
<b>POWER SUPPLY CURRENTS</b> <sup>(2)</sup>													
VRE100 +PS		5	7		*	*		*	*		*	*	mA
VRE101 -PS		5	7		*	*		*	*		*	*	mA
VRE102 +PS		7	9		*	*		*	*		*	*	mA
VRE102 -PS		4	6		*	*		*	*		*	*	mA

NOTES: \*Same as C Models.

1. Using the box method, the specified value is the maximum deviation from the output voltage at 25°C over the specified operating temperature range.

2. The specified values are unloaded.

# TYPICAL PERFORMANCE CURVES

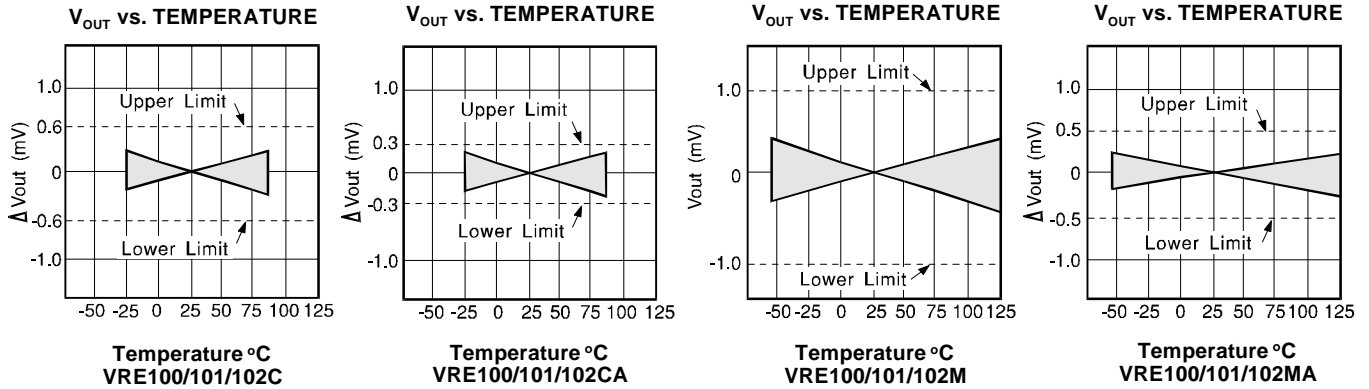

## VRE100/101

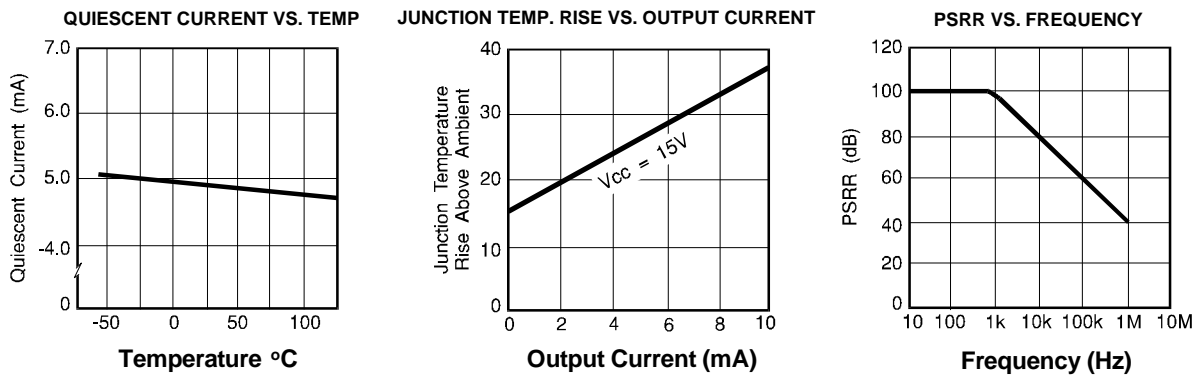

## VRE102

### POSITIVE OUTPUT

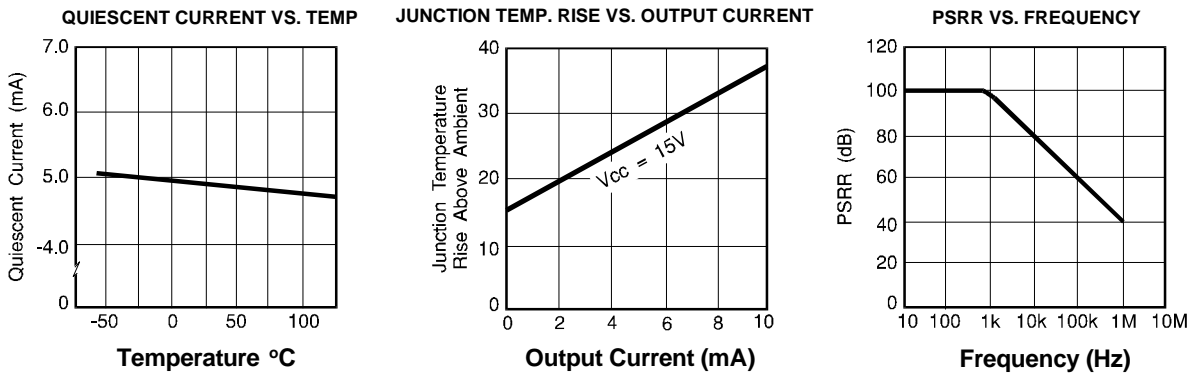

### NEGATIVE OUTPUT

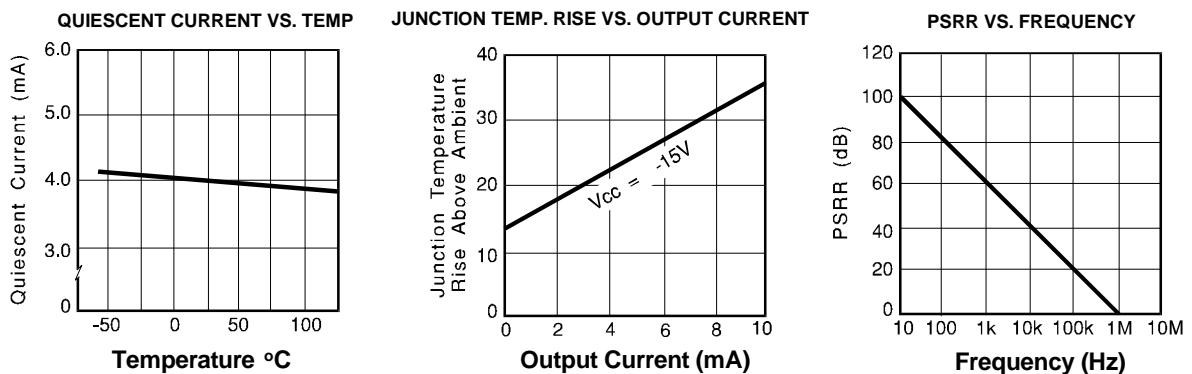

# DISCUSSION OF PERFORMANCE

## THEORY OF OPERATION

The following discussion refers to the schematic below. In operation, approximately 6.3 volts is applied to the noninverting input of the op amp. The voltage is amplified by the op amp to produce a 10.000V output. The gain is determined by the networks R1 and R2:  $G=1 + R2/R1$ . The 6.3V zener diode is used because it is the most stable diode over time and temperature.

The zener operating current is derived from the regulated output voltage through R3. This feedback arrangement provides a closely regulated zener current. This current determines the slope of the references' voltage vs. temperature function. By trimming the zener current a lower drift over temperature can be achieved. But since the voltage vs. temperature function is nonlinear this compensation technique is not well suited for wide temperature ranges.

Thaler Corporation has developed a nonlinear compensation network of thermistors and resistors that is used in the VRE series voltage references. This proprietary network eliminates most of the nonlinearity in the voltage vs. temperature function. By then adjusting the slope, Thaler Corporation produces a very stable voltage over wide temperature ranges. This network is less than 2% of the overall network resistance so it has a negligible effect on long term stability. By using highly stable resistors in our network, we produce a voltage reference that also has very good long term stability.

## APPLICATION INFORMATION

Figure 1 shows the proper connection of the VRE100 series voltage reference with the optional trim resistors. When trimming the VRE102, the positive voltage should be trimmed first since the negative voltage tracks the positive side. Pay careful attention to the circuit layout to avoid noise pickup and voltage drops in the lines.

The VRE100 series voltage references have the ground terminal brought out on two pins (pin 6 and pin 7) which are connected together internally. This allows the user to achieve greater accuracy when using a socket. Voltage references have a voltage drop across their power supply ground pin due to quiescent current flowing through the contact resistance. If the contact resistance was constant with time and temperature, this voltage drop could be trimmed out. When the reference is plugged into a socket, this source of error can be as high as 20ppm. By connecting pin 7 to the power supply ground and pin 6 to a high impedance ground point in the measurement circuit, the error due to the contact resistance can be eliminated. If the unit is soldered into place the contact resistance is sufficiently small that it doesn't effect performance. The VRE series voltage references can be connected with or without the use of pin 6 and still provide performance superior to the 2700 and 2710 series voltage references.

### VRE100

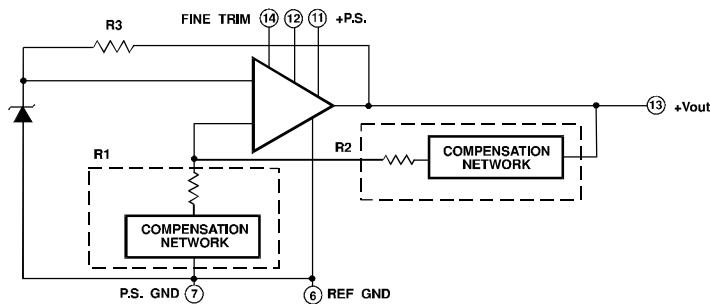

### VRE102

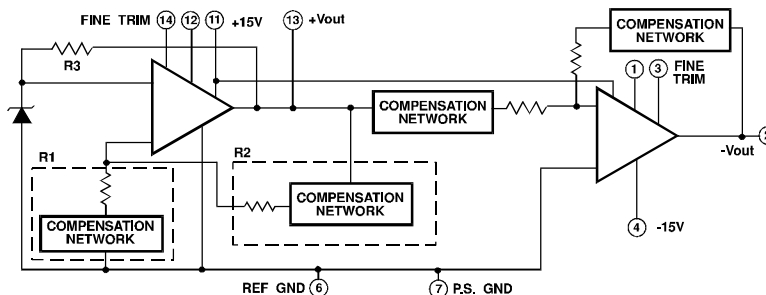
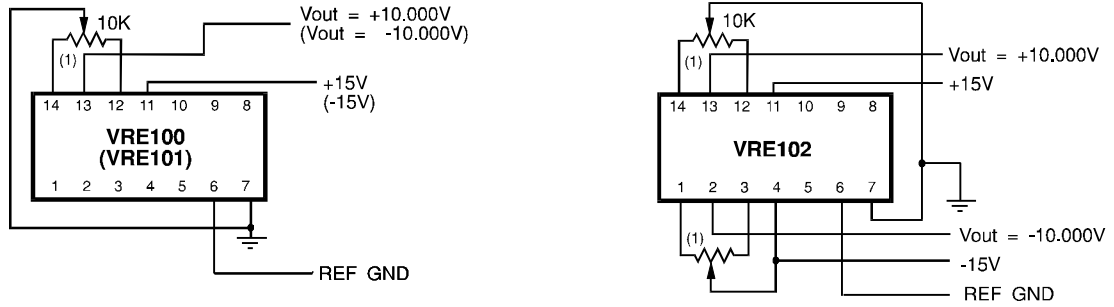

FIGURE 1

## EXTERNAL CONNECTIONS



1. Optional Fine Adjust for approximately  $\pm 20\text{mV}$ . VRE101 center tap connects to -PS.

## PIN CONFIGURATION

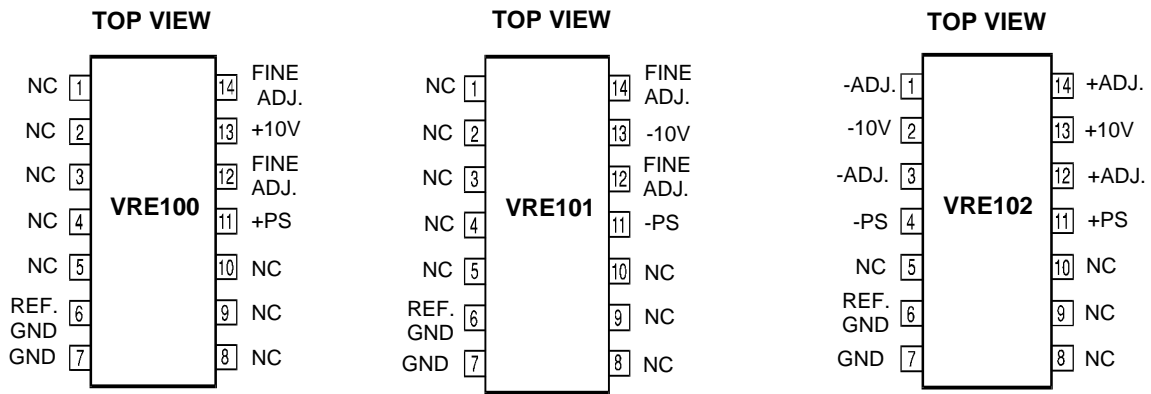

## MECHANICAL

### 14-PIN HYBRID PACKAGE

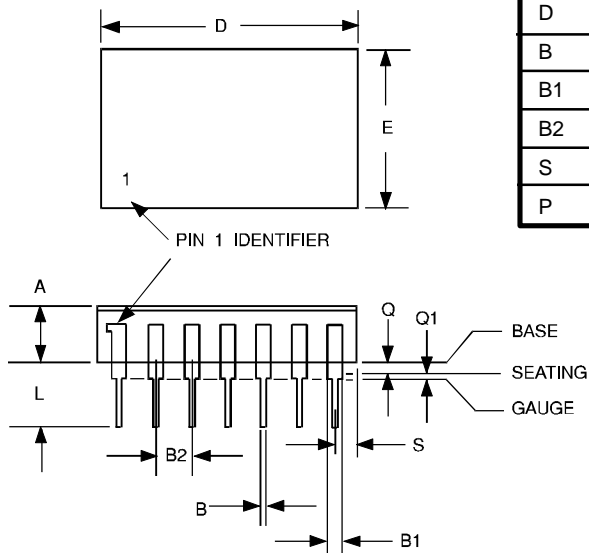

DIM	INCHES		MILLIMETER		DIM	INCHES		MILLIMETER	
	MIN	MAX	MIN	MAX		MIN	MAX	MIN	MAX
E	.480	.500	12.1	12.7	A	.120	.155	3.0	4.0
L	.195	.215	4.9	5.4	Q	.015	.035	0.4	0.9
D	.775	.805	19.7	20.4	Q1	N/A	.030	N/A	0.7
B	.016	.020	0.4	0.5	C	.009	.012	0.2	0.3
B1	.038	.042	0.9	1.0	G1	.290	.310	7.3	7.8
B2	.095	.105	2.4	2.6					
S	.085	.105	2.1	2.6					
P	.004	.006	0.10	0.15					