



SMP50 / SMTPA / TPA

TRISIL™ FOR TELECOM EQUIPMENT PROTECTION

FEATURES

- Bidirectional crowbar protection
- Voltage range from 62V to 270V
- Low capacitance from 12pF to 20pF @ 50V
- Low leakage current : $I_R = 2\mu A$ max
- Holding current: $I_H = 150$ mA min
- Repetitive peak pulse current :
 $I_{PP} = 50$ A (10/1000 μ s)

MAIN APPLICATIONS

Telecommunication equipment such as:

- Analog and digital line cards (xDSL, T1/E1, ISDN, ...)
- Terminals (phone, fax, modem, ...) and central office equipment

DESCRIPTION

These Trisil series have been designed to protect telecommunication equipment against lightning and transient induced by AC power lines. They are available in SMA, SMB and DO-15 packages.

BENEFITS

Trisils are not subject to ageing and provide a fail safe mode in short circuit for a better protection. They are used to help equipment to meet various standards such as UL1950, IEC950 / CSA C22.2, UL1459 and FCC part 68.

Trisils have UL94 V0 approved resin.

SMA and SMB packages are JEDEC registered (DO-214AC and DO-214AA).

Trisils are UL497B approved (file: E136224).

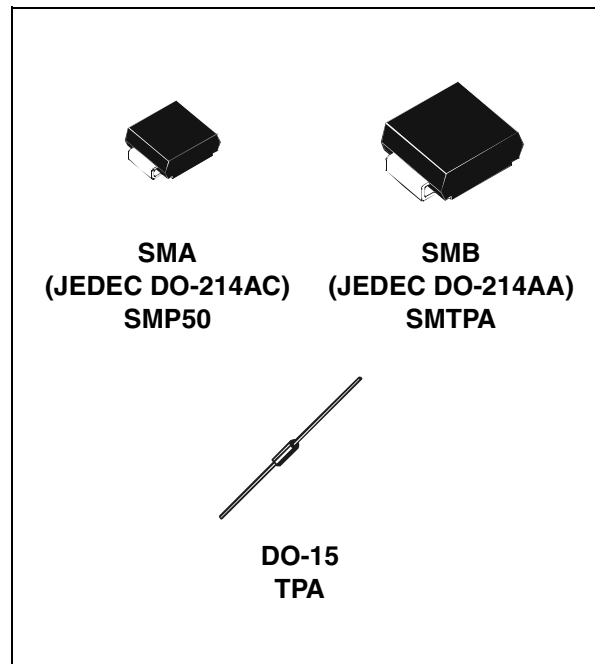

Table 1: Order Codes

Part Number	Marking
SMP50-xxx	See page 9
TPAxxx	
SMTPAxxx	

Figure 1: Schematic Diagram

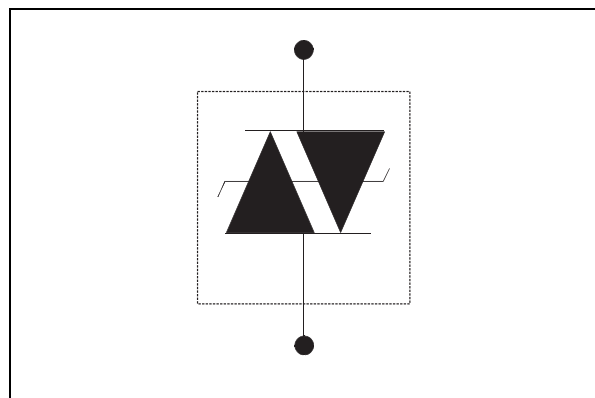

Table 2: In compliances with the following standards

STANDARD	Peak Surge Voltage (V)	Waveform Voltage	Required peak current (A)	Current waveform	Minimum serial resistor to meet standard (Ω)
GR-1089 Core First level	2500	2/10 μ s	500	2/10 μ s	20
	1000	10/1000 μ s	100	10/1000 μ s	10
GR-1089 Core Second level	5000	2/10 μ s	500	2/10 μ s	40
GR-1089 Core Intra-building	1500	2/10 μ s	100	2/10 μ s	0
ITU-T-K20/K21	6000	10/700 μ s	150	5/310 μ s	53
	1500		37.5		0
ITU-T-K20 (IEC61000-4-2)	8000	1/60 ns	ESD contact discharge		0
	15000		ESD air discharge		0
VDE0433	4000	10/700 μ s	100	5/310 μ s	21.5
	2000		50		0
VDE0878	4000	1.2/50 μ s	100	1/20 μ s	0
	2000		50		0
IEC61000-4-5	4000	10/700 μ s	100	5/310 μ s	21.5
	4000	1.2/50 μ s	100	8/20 μ s	0
FCC Part 68, lightning surge type A	1500	10/160 μ s	200	10/160 μ s	12.5
	800	10/560 μ s	100	10/560 μ s	6.5
FCC Part 68, lightning surge type B	1000	9/720 μ s	25	5/320 μ s	0

Table 3: Absolute Ratings ($T_{amb} = 25^{\circ}\text{C}$)

Symbol	Parameter		Value	Unit
I_{PP}	Repetitive peak pulse current (see figure 2)	10/1000 μ s	50	A
		8/20 μ s	100	
		10/560 μ s	55	
		5/310 μ s	65	
		10/160 μ s	75	
		1/20 μ s	100	
		2/10 μ s	100	
I_{FS}	Fail-safe mode : maximum current (note 1)	8/20 μ s	2.5	kA
I_{TSM}	Non repetitive surge peak on-state current (sinusoidal)	t = 0.2 s	16	A
		t = 1 s	11.5	
		t = 2 s	10	
		t = 15 mn	3.5	
I^2t	I^2t value for fusing	t = 16.6 ms	6.2	A^2s
		t = 20 ms	6.5	
T_{stg}	Storage temperature range		-55 to 150	$^{\circ}\text{C}$
T_j	Maximum junction temperature		150	$^{\circ}\text{C}$
T_L	Maximum lead temperature for soldering during 10 s.		260	$^{\circ}\text{C}$

Note 1: in fail safe mode, the device acts as a short circuit

Table 4: Thermal Resistances

Symbol	Parameter	Value			Unit
		DO-15	SMA	SMB	
$R_{th(j-a)}$	Junction to ambient (with recommended footprint or with $L_{lead} = 10mm$ for DO-15)	100	120	100	°C/W
$R_{th(j-l)}$	Junction to leads ($L_{lead} = 10mm$ for DO-15)	60	30	20	°C/W

Table 5: Electrical Characteristics ($T_{amb} = 25^{\circ}C$)

Symbol	Parameter
V_{RM}	Stand-off voltage
V_{BR}	Breakdown voltage
V_{BO}	Breakover voltage
I_{RM}	Leakage current
I_{PP}	Peak pulse current
I_{BO}	Breakover current
I_H	Holding current
V_R	Continuous reverse voltage
I_R	Leakage current at V_R
C	Capacitance

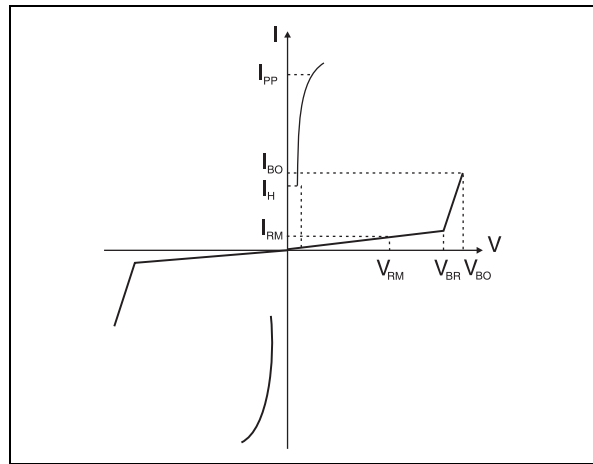

Types	$I_{RM} @ V_{RM}$		$I_R @ V_R$		Dynamic V_{BO}	Static $V_{BO} @ I_{BO}$		I_H	C	C
	max.		max.		max.	max.	max.	min.	typ.	typ.
	μA	V	μA	V	V	V	mA	mA	pF	pF
			note 1		note 2	note 3		note 4	note 5	note 6
SMP50-62 / TPA62 SMTPA62		56		62	85	82	800	150	20	40
SMP50-68 / TPA68 SMTPA68		61		68	93	90			20	40
SMP50-100 / TPA100 SMTPA100		90		100	135	133			16	35
SMP50-120 / TPA120 SMTPA120		108		120	160	160			16	30
SMP50-130 / TPA130 SMTPA130		117		130	173	173			14	30
SMP50-180 / TPA180 SMTPA180	2	162	5	180	235	240			14	25
SMP50-200 / TPA200 SMTPA200		180		200	262	267			12	25
SMP50-220 / TPA220 SMTPA220		198		220	285	293			12	25
SMP50-240 / TPA240 SMTPA240		216		240	300	320			12	25
SMP50-270 / TPA270 SMTPA270		243		270	350	360			12	25

Note 1: I_R measured at V_R guarantee $V_{BR} \min \geq V_R$

Note 2: see functional test circuit 1

Note 3: see test circuit 2

Note 4: see functional holding current test circuit 3

Note 5: $V_R = 50V$ bias, $V_{RMS}=1V$, $F=1MHz$

Note 6: $V_R = 2V$ bias, $V_{RMS}=1V$, $F=1MHz$

Figure 2: Pulse waveform (10/1000µs)

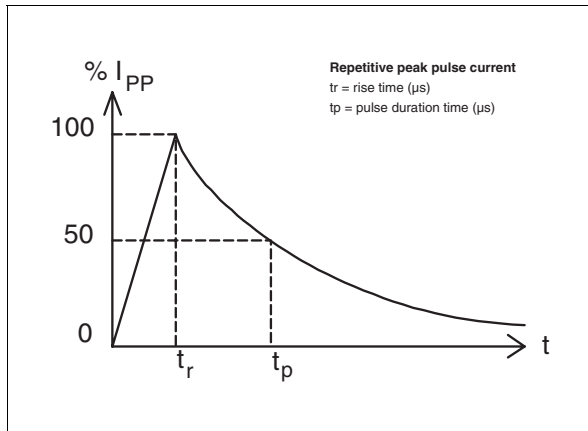

Figure 3: Non repetitive surge peak on-state current versus overload duration

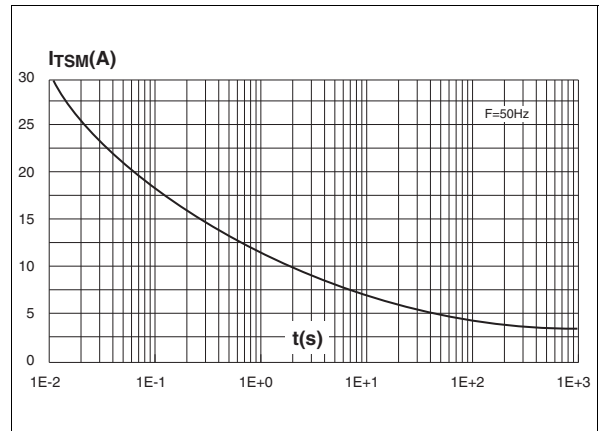

Figure 4: On-state voltage versus on-state current (typical values)

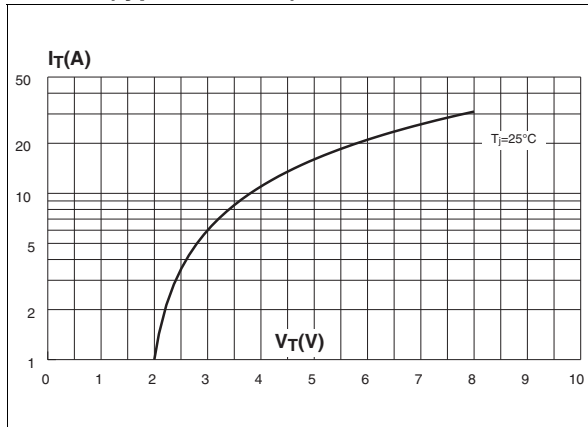

Figure 5: Relative variation of holding current versus junction temperature

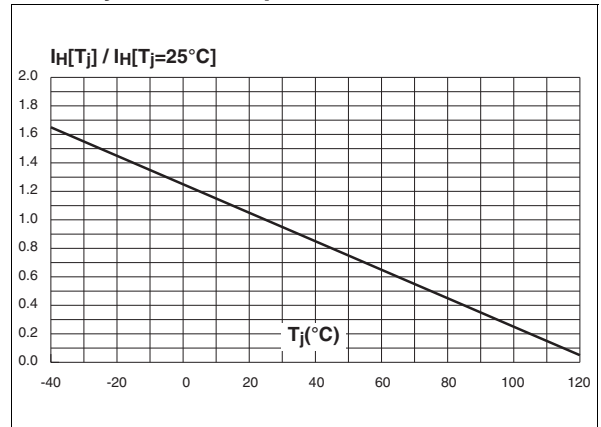

Figure 6: Relative variation of breakover voltage versus junction temperature

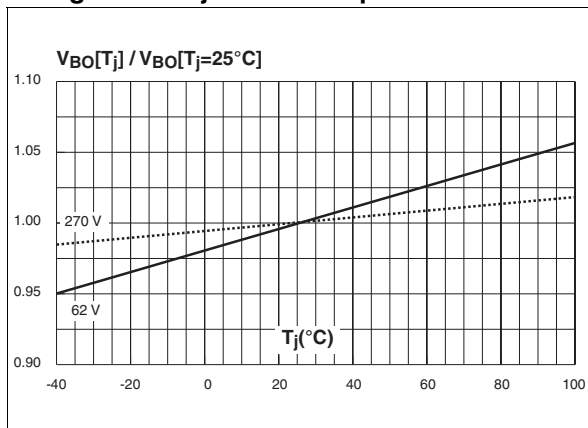

Figure 7: Relative variation of leakage current versus reverse voltage applied (typical values)

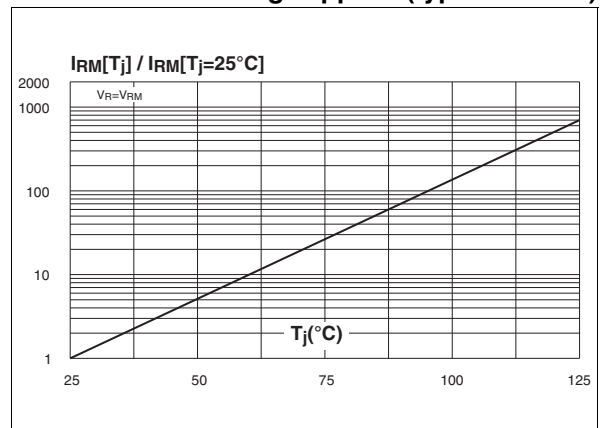

Figure 8: Variation of thermal impedance junction to ambient versus pulse duration (Printed circuit board FR4, SCu=35µm, recommended pad layout)

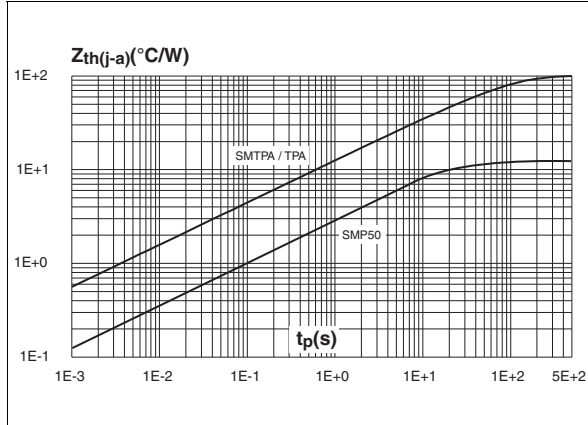

Figure 9: Relative variation of junction capacitance versus reverse voltage applied (typical values)

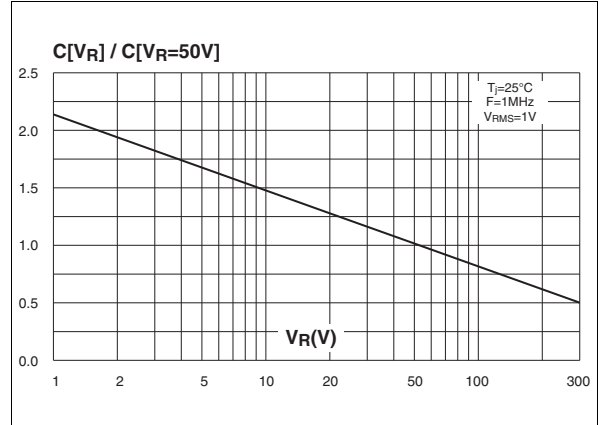

Figure 10: Test circuit 1 for Dynamic I_{BO} and V_{BO} parameters

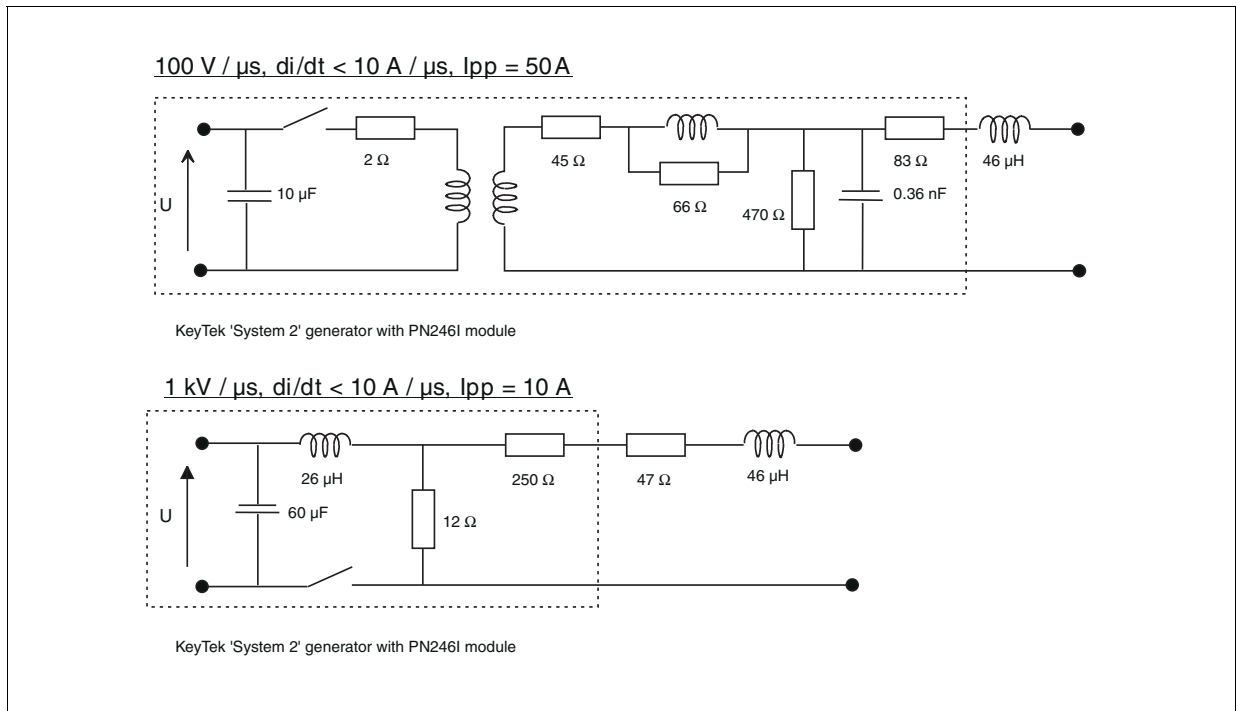

Figure 11: Test circuit 2 for I_{BO} and V_{BO} parameters

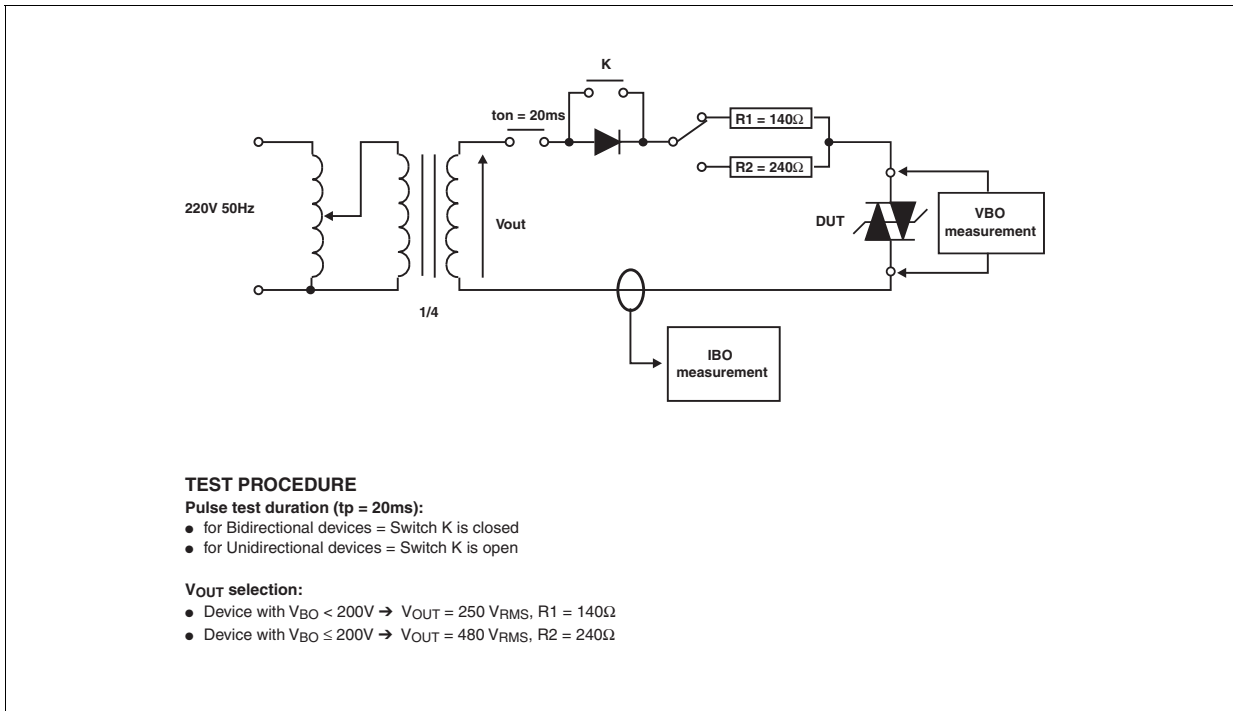

Figure 12: Test circuit 3 for dynamic I_H parameters

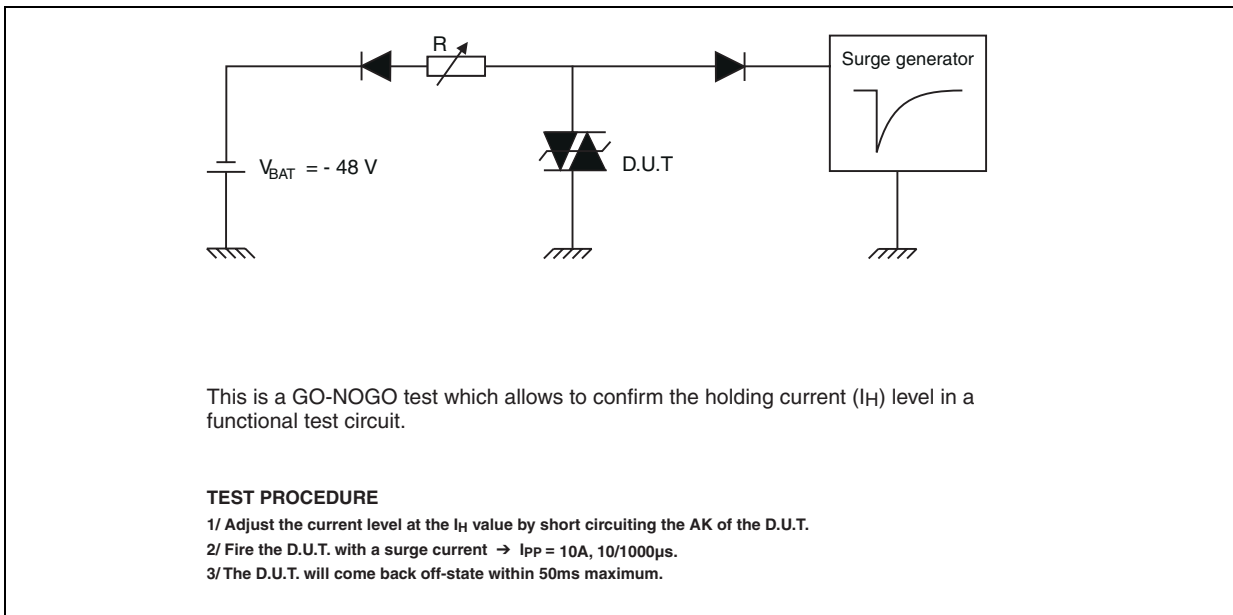

Figure 13: Ordering Information Scheme

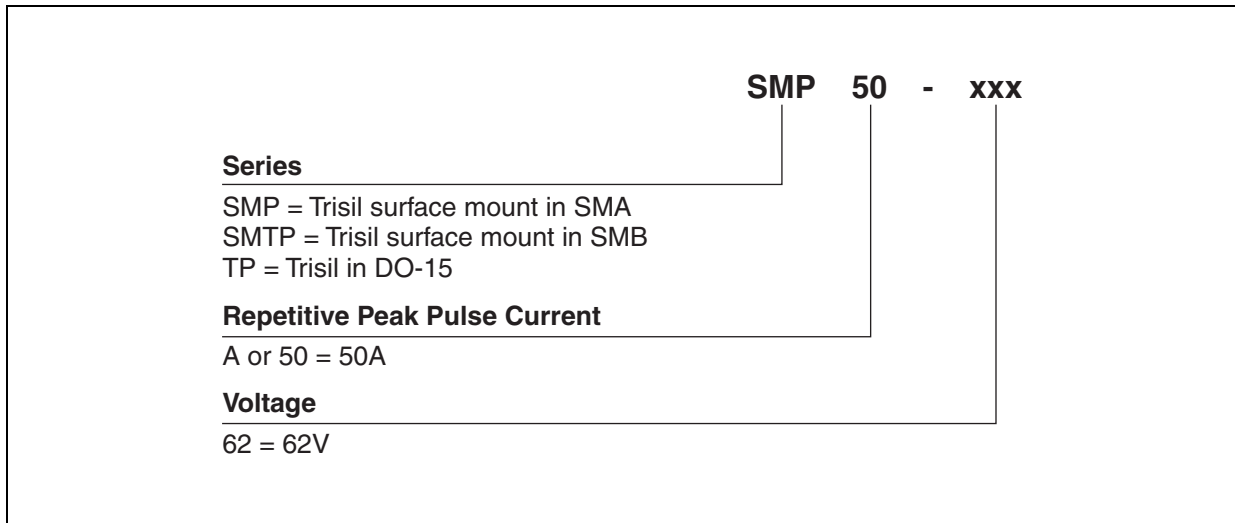

Figure 14: SMA Package Mechanical Data

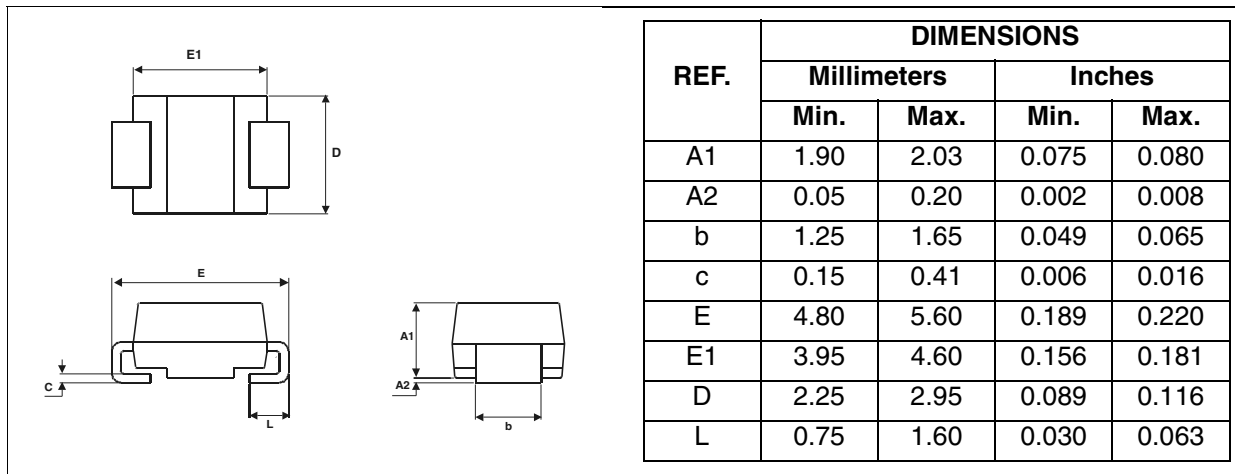

Figure 15: Foot Print Dimensions (in millimeters)

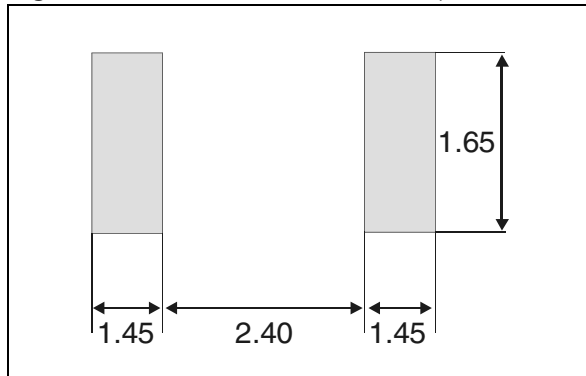

Figure 16: SMB Package Mechanical Data

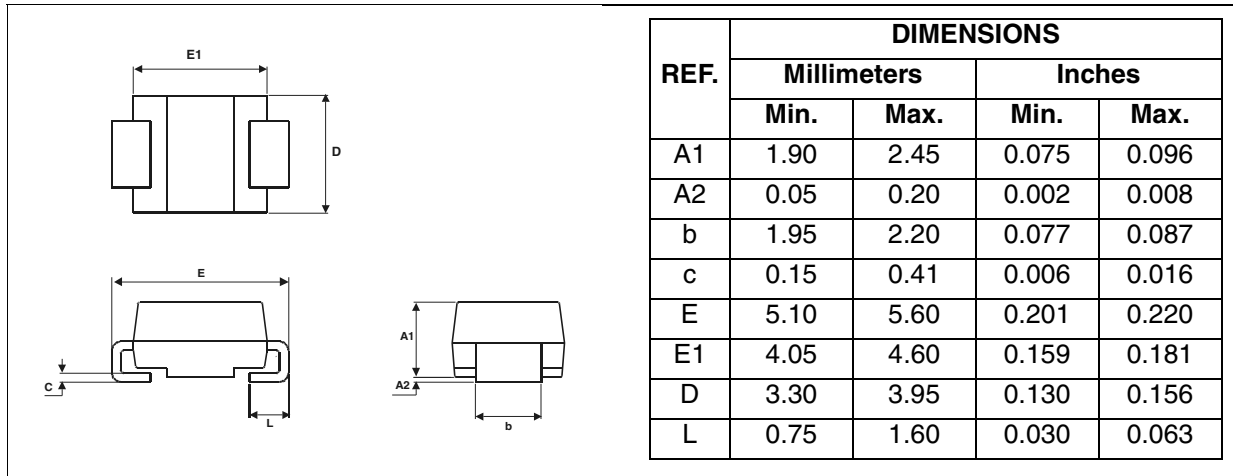

Figure 17: Foot Print Dimensions (in millimeters)

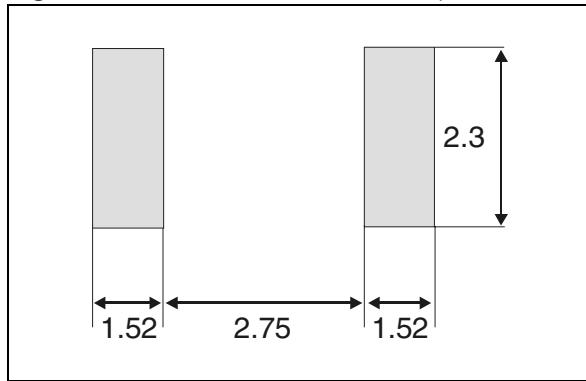

Figure 18: DO-15 Package Mechanical data

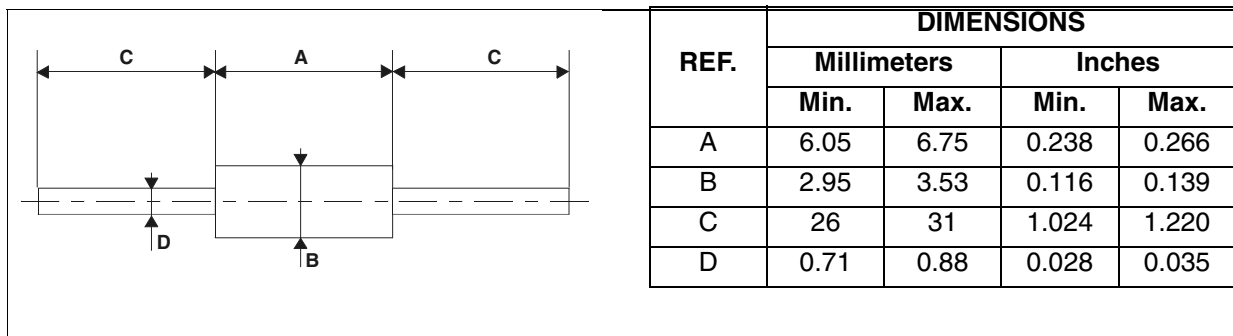

Table 6: Ordering Information

Part Number	Marking	Package	Weight	Base qty	Delivery mode
SMP50-62	V06	SMA	0.068 g	5000	Tape & reel
SMP50-68	V07				
SMP50-100	V10				
SMP50-120	V12				
SMP50-130	V13				
SMP50-180	V18				
SMP50-200	V20				
SMP50-220	V22				
SMP50-240	V24				
SMP50-270	V27				
SMTPA62	U01	SMB	0.11 g	2500	Tape & reel
SMTPA68	U05				
SMTPA100	U13				
SMTPA120	U17				
SMTPA130	U19				
SMTPA180	U25				
SMTPA200	U27				
SMTPA220	U31				
SMTPA240	U35				
SMTPA270	U39				
TPA62	TPA62	DO-15	0.40 g	1000	Ammopack
TPA62RL				6000	Tape & reel
TPA68	TPA68			1000	Ammopack
TPA68RL				6000	Tape & reel
TPA100	TPA100			1000	Ammopack
TPA100RL				6000	Tape & reel
TPA120	TPA120			1000	Ammopack
TPA130	TPA130			1000	Ammopack
TPA130RL				6000	Tape & reel
TPA180	TPA180			1000	Ammopack
TPA180RL				6000	Tape & reel
TPA200	TPA200			1000	Ammopack
TPA200RL				6000	Tape & reel
TPA220	TPA220			1000	Ammopack
TPA220RL				6000	Tape & reel
TPA240	TPA240			1000	Ammopack
TPA240RL				6000	Tape & reel
TPA270	TPA270			1000	Ammopack
TPA270RL				6000	Tape & reel

Table 7: Revision History

Date	Revision	Description of Changes
16-Nov-2004	1	SMP50, SMTPA and TPA datasheets merge.

Information furnished is believed to be accurate and reliable. However, STMicroelectronics assumes no responsibility for the consequences of use of such information nor for any infringement of patents or other rights of third parties which may result from its use. No license is granted by implication or otherwise under any patent or patent rights of STMicroelectronics. Specifications mentioned in this publication are subject to change without notice. This publication supersedes and replaces all information previously supplied. STMicroelectronics products are not authorized for use as critical components in life support devices or systems without express written approval of STMicroelectronics.

The ST logo is a registered trademark of STMicroelectronics.
All other names are the property of their respective owners

© 2004 STMicroelectronics - All rights reserved

STMicroelectronics group of companies

Australia - Belgium - Brazil - Canada - China - Czech Republic - Finland - France - Germany - Hong Kong - India - Israel - Italy - Japan -
Malaysia - Malta - Morocco - Singapore - Spain - Sweden - Switzerland - United Kingdom - United States of America

www.st.com