



# BAT54J / W / AW / CW / SW

## SMALL SIGNAL SCHOTTKY DIODE

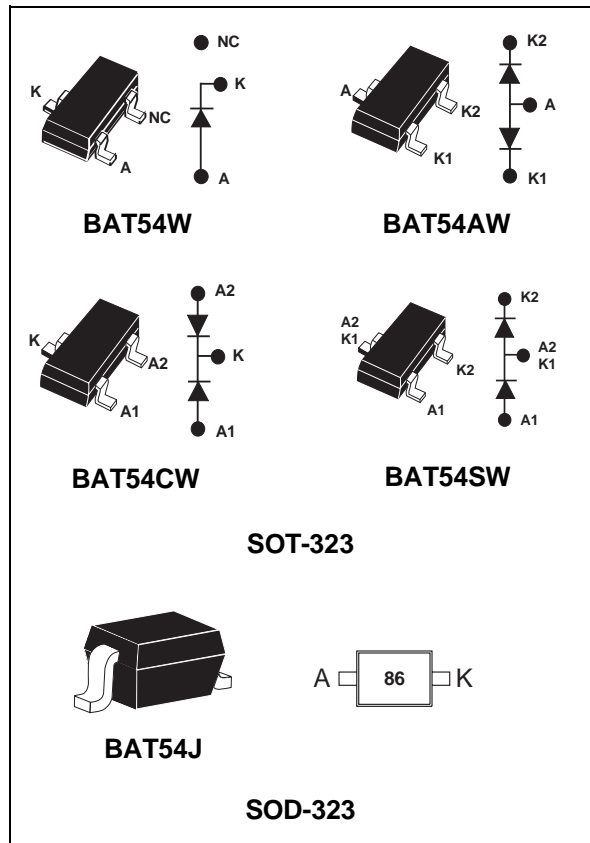
### FEATURES AND BENEFITS

- VERY SMALL CONDUCTION LOSSES
- NEGLIGIBLE SWITCHING LOSSES
- LOW FORWARD VOLTAGE DROP
- SURFACE MOUNT DEVICE

### DESCRIPTION

Schottky barrier diodes encapsulated either in SOT-323 or SOD-323 small SMD packages.

Single and double diodes with different pinning are available.



### ABSOLUTE RATINGS (limiting values)

Symbol	Parameter		Value	Unit
$V_{RRM}$	Repetitive peak reverse voltage		30	V
$I_F$	Continuous forward current		0.3	A
$I_{FSM}$	Surge non repetitive forward current	$t_p=10ms$ sinusoidal	1	A
$P_{tot}$	Power dissipation (note 1) $T_{amb} = 25^\circ C$	SOD-323	230	mW
		SOT-323		
$T_{stg}$	Maximum storage temperature range		- 65 to +150	$^\circ C$
$T_j$	Maximum operating junction temperature *		150	$^\circ C$
$T_L$	Maximum temperature for soldering during 10s		260	$^\circ C$

**Note 1:** for double diodes,  $P_{tot}$  is the total dissipation of both diodes

\* :  $\frac{dP_{tot}}{dT_j} < \frac{1}{R_{th(j-a)}}$  thermal runaway condition for a diode on its own heatsink

# BAT54J / W / AW / CW / SW

## THERMAL RESISTANCE

Symbol	Parameters		Value	Unit
R <sub>th(j-a)</sub>	Junction to ambient (*)	SOD-323	550	°C/W
		SOT-323		°C/W

(\*) Mounted on epoxy board, with recommended pad layout.

## STATIC ELECTRICAL CHARACTERISTICS (per diode)

Symbol	Parameters	Tests conditions		Min.	Typ.	Max.	Unit
V <sub>F</sub> *	Forward voltage drop	T <sub>j</sub> = 25°C	I <sub>F</sub> = 0.1 mA			240	mV
			I <sub>F</sub> = 1 mA			320	
			I <sub>F</sub> = 10 mA			400	
			I <sub>F</sub> = 30 mA			500	
			I <sub>F</sub> = 100 mA			900	
I <sub>R</sub> **	Reverse leakage current	T <sub>j</sub> = 25°C	V <sub>R</sub> = 30 V			1	μA
		T <sub>j</sub> = 100°C				100	

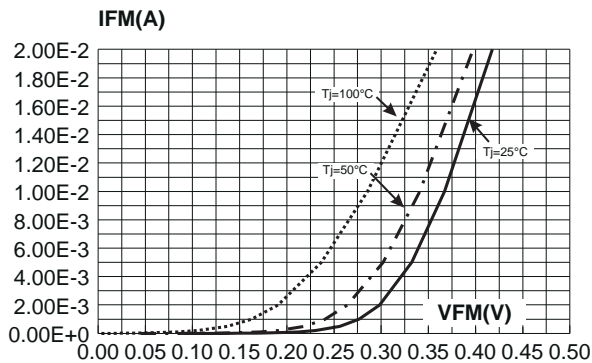
Pulse test : \* t<sub>p</sub> = 380 μs, δ < 2%

\*\* t<sub>p</sub> = 5 ms, δ < 2%

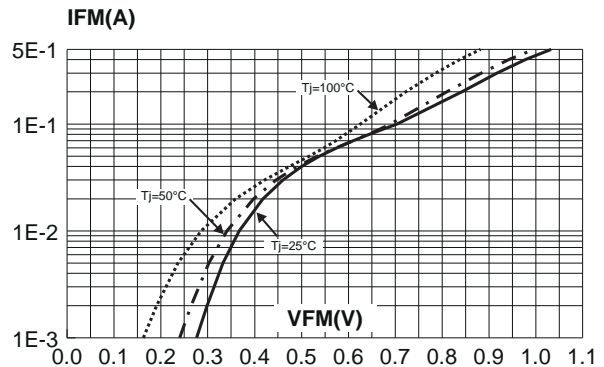
## DYNAMIC CHARACTERISTICS (T<sub>j</sub> = 25 °C)

Symbol	Parameters	Tests conditions	Min.	Typ.	Max.	Unit
C	Junction capacitance	T <sub>j</sub> = 25°C V <sub>R</sub> = 1 V F = 1 MHz			10	pF
t <sub>rr</sub>	Reverse recovery time	I <sub>F</sub> = 10 mA I <sub>R</sub> = 10 mA T <sub>j</sub> = 25°C I <sub>rr</sub> = 1 mA R <sub>L</sub> = 100 Ω			5	ns

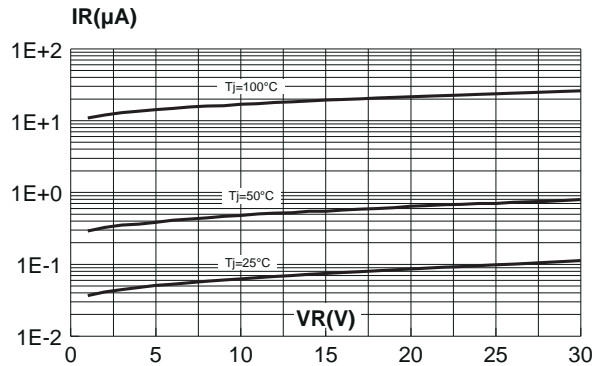
**Fig. 1-1:** Forward voltage drop versus forward current (typical values, low level).



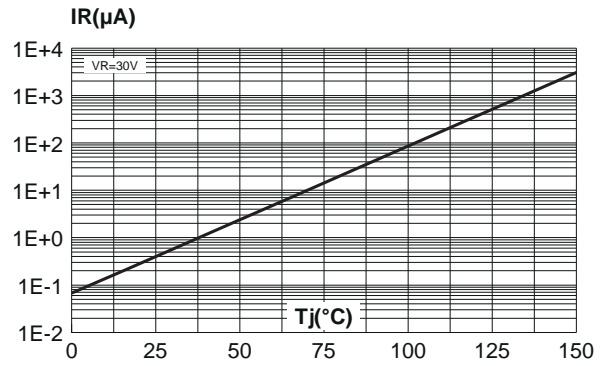
**Fig. 1-2:** Forward voltage drop versus forward current (typical values, high level).



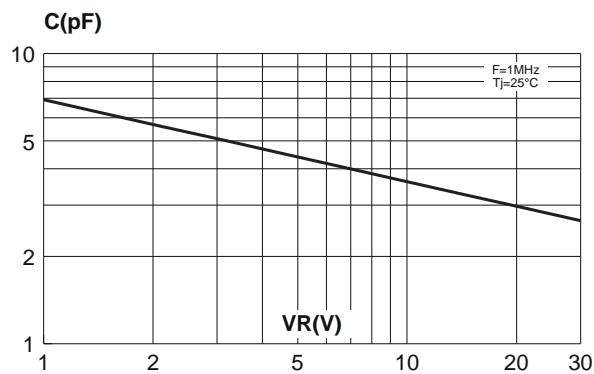
**Fig. 2:** Reverse leakage current versus reverse voltage applied (typical values).



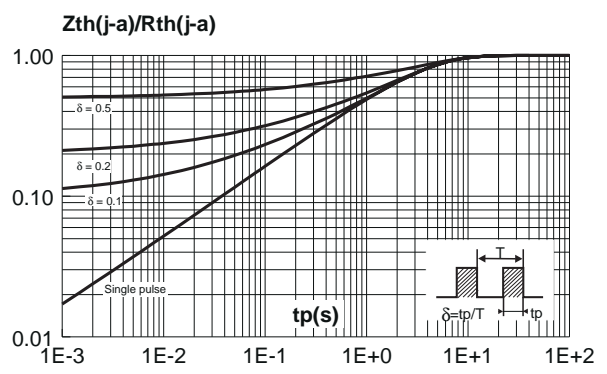
**Fig. 3:** Reverse leakage current versus junction temperature.



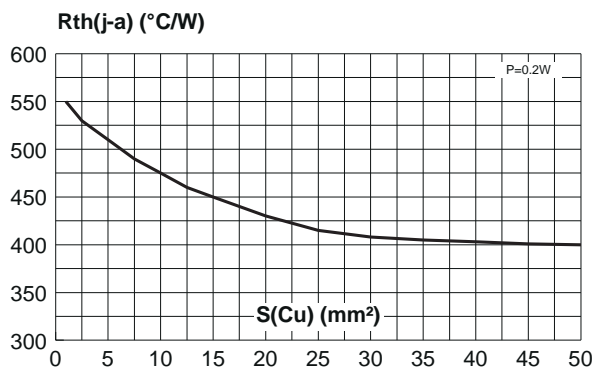
**Fig. 4:** Junction capacitance versus reverse voltage applied (typical values).



**Fig. 5:** Relative variation of thermal impedance junction to ambient versus pulse duration (epoxy FR4 with recommended pad layout,  $e(\text{Cu}) = 35\mu\text{m}$ )

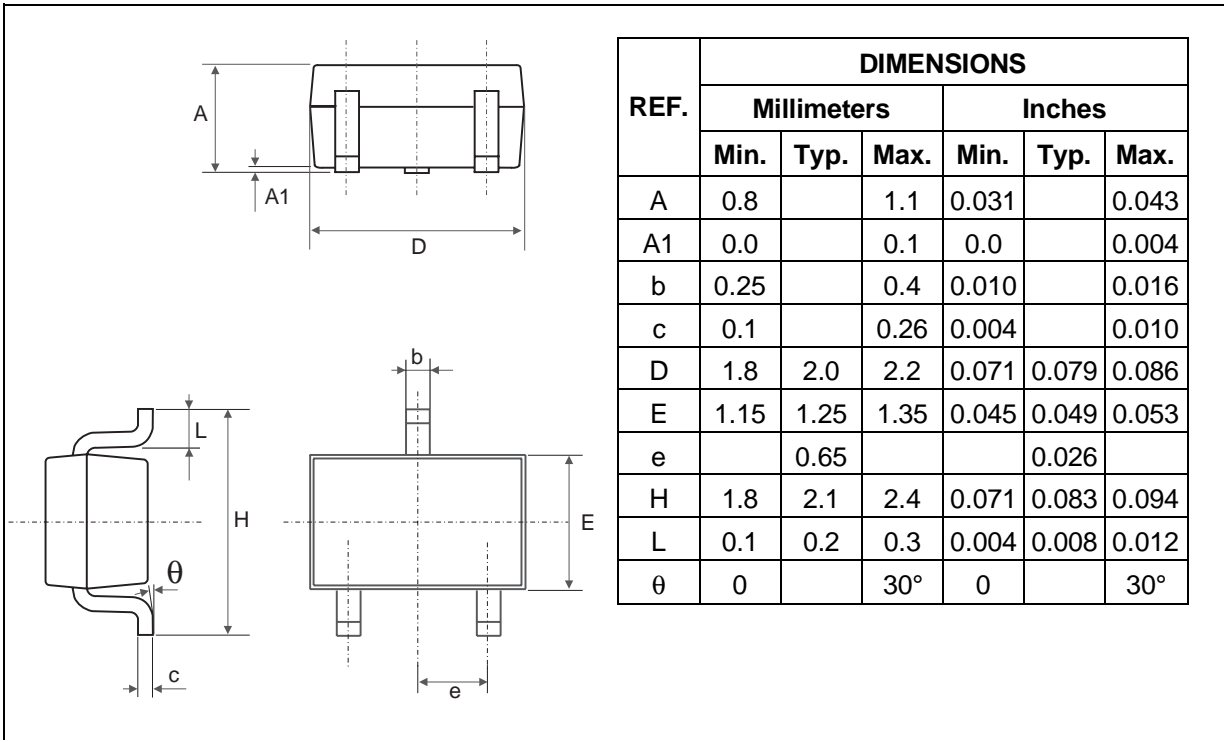


**Fig. 6:** Thermal resistance junction to ambient versus copper surface under each lead (Epoxy printed circuit board FR4, copper thickness:  $35\mu\text{m}$ .)

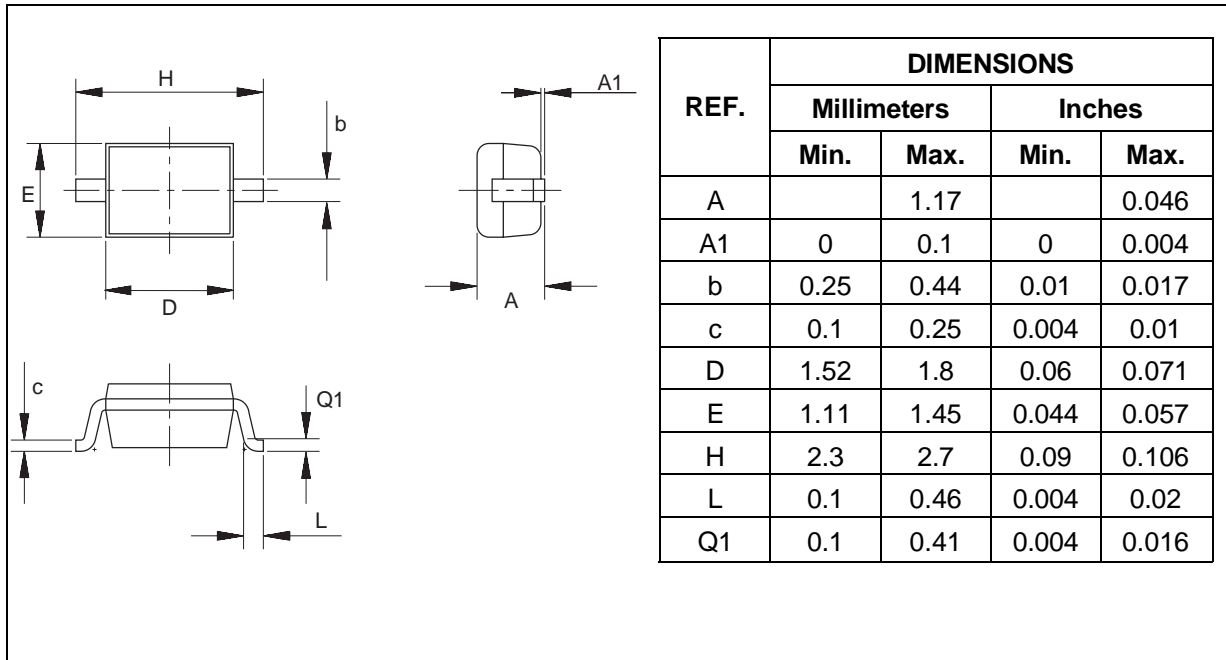


**BAT54J / W / AW / CW / SW**

**PACKAGE MECHANICAL DATA**  
SOT-323



**PACKAGE MECHANICAL DATA**  
SOD-323



Ordering type	Marking	Package	Weight	Base qty	Delivery mode
BAT54W	D73	SOT-323	0.006g	3000	Tape & reel
BAT54AW	D74	SOT-323	0.006g	3000	Tape & reel
BAT54CW	D77	SOT-323	0.006g	3000	Tape & reel
BAT54SW	D78	SOT-323	0.006g	3000	Tape & reel
BAT54J	86	SOD-323	0.005g	3000	Tape & reel

■ Epoxy meets UL94,V0

Information furnished is believed to be accurate and reliable. However, STMicroelectronics assumes no responsibility for the consequences of use of such information nor for any infringement of patents or other rights of third parties which may result from its use. No license is granted by implication or otherwise under any patent or patent rights of STMicroelectronics. Specifications mentioned in this publication are subject to change without notice. This publication supersedes and replaces all information previously supplied. STMicroelectronics products are not authorized for use as critical components in life support devices or systems without express written approval of STMicroelectronics.

The ST logo is a registered trademark of STMicroelectronics

© 1999 STMicroelectronics - Printed in Italy - All rights reserved.

STMicroelectronics GROUP OF COMPANIES

Australia - Brazil - China - Finland - France - Germany - Hong Kong - India - Italy - Japan - Malaysia  
Malta - Morocco - Singapore - Spain - Sweden - Switzerland - United Kingdom - U.S.A.

<http://www.st.com>