

Leaded Surface Mount Mixer



M18L

Features

- Low Conversion Loss 6.5 dB (Typ.)
- High Isolation 28 dB (Typ.)
- Low Profile 0.085 (Max.)
- Stress Relieved Leaded Package
- High Performance Diode Ring Mixer

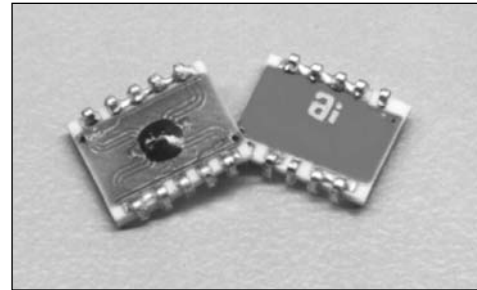

Description

The M18L is designed to be used in wireless systems that are targeted for low-cost/high volume applications. It is a hybrid mixer utilizing the best of Alpha's semiconductor, circuit design and manufacturing capabilities. A custom silicon MMIC is complimented by a rugged thick-film ceramic circuit which doubles as the surface mount package. Wrap-around stress relieving leads ease installation and inspection as well as solve thermal expansion mismatch problems.

Pin Out

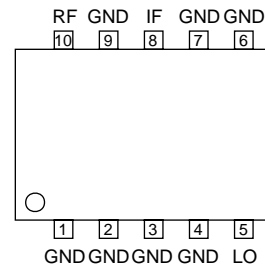

Block Diagram

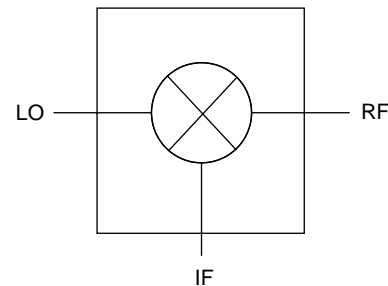

Electrical Specifications at 25°C

Parameter	Min.	Typ.	Max.	Unit
RF Frequency Range	1.7		2.0	GHz
LO Frequency Range	1.7		2.0	GHz
IF Frequency Range	DC		0.3	GHz
LO Power		+7		dBm
Conversion Loss		6.5	8.0	dB
LO to RF Isolation	22	28		dB
LO to IF Isolation	18	22		dB
RF to IF Isolation	17	20		dB
RF VSWR		1.5:1	2.0:1	
LO VSWR		1.5:1	2.0:1	
IF VSWR		1.5:1	2.0:1	
Input Compression Pt.	0	+2		dBm
IP3	+10	11		dBm

Typical Performance Data

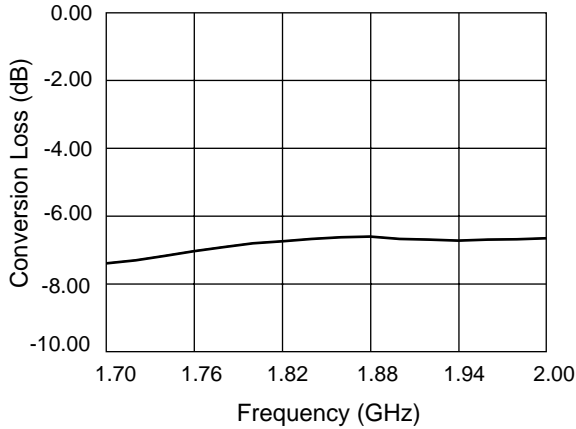

Conversion Loss vs. Frequency

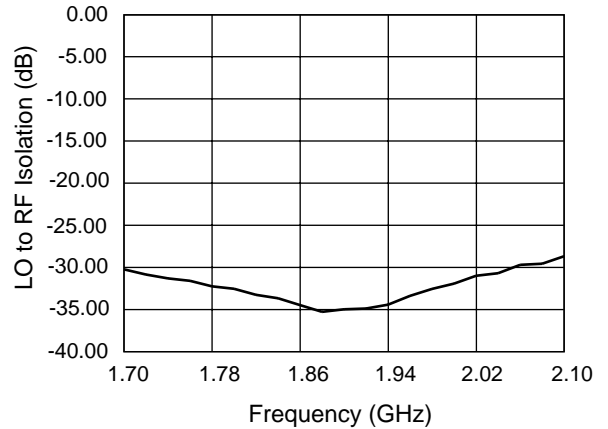

LO to RF Isolation vs. Frequency

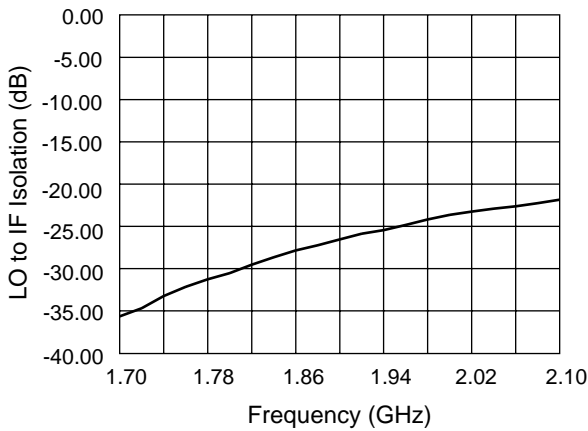

LO to IF Isolation vs. Frequency

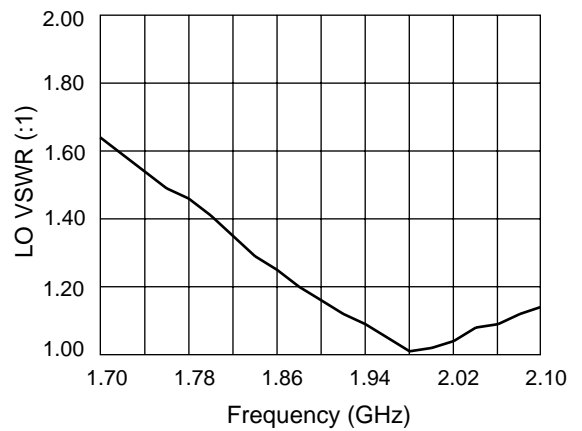

LO VSWR vs. Frequency

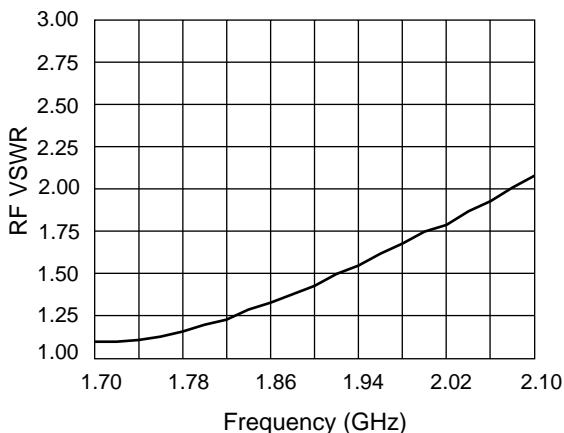

RF VSWR vs. Frequency

Board Layout

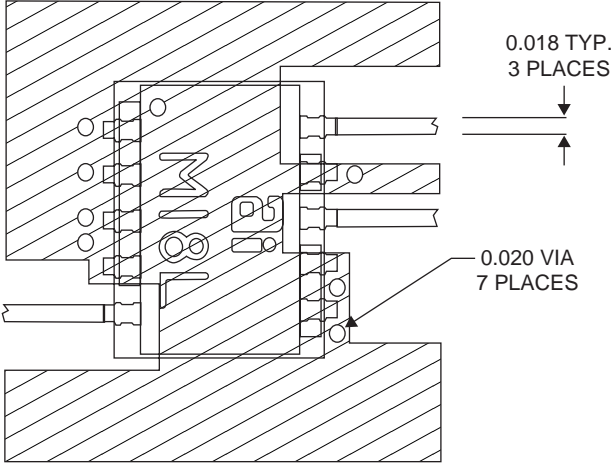

Ckt. Material is 10 mil FR4

M18L

