

## Symbol MULTILED® 5 mm (T1 3/4), Partly Diffused

LU H371

### Besondere Merkmale

- nicht eingefärbtes, teilweise diffuses Gehäuse
- Lötspieße im 2.54 mm Raster
- Hohe Signalwirkung durch Farbwechsel der LED möglich von grün zu gelb und orange nach superrot
- geeignet für Multiplex- und Impulsbetrieb
- beide Grundfarben grün und rot getrennt ansteuerbar
- Lötspieße mit Aufsetzebene
- gegurtet lieferbar
- Störimpulsfest nach DIN 40839

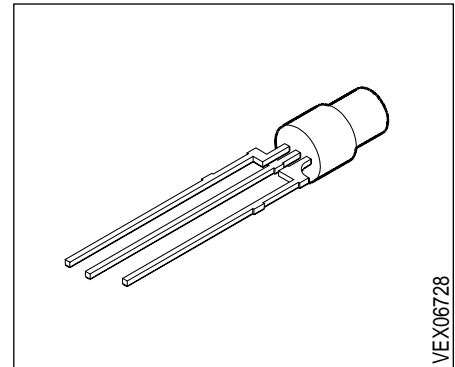

### Features

- partly diffused, colorless package
- 2.54 mm lead spacing
- high signal efficiency by color change of the LED from green to yellow and orange to superred
- ideal for multiplexed or pulsed operations
- both colors can be controlled separately
- solder leads with stand-off
- available taped on reel
- load dump resistant acc. to DIN 40839

Typ Type	Emissionsfarbe Color of Emission	Gehäusefarbe Color of Package	Lichtstärke Luminous Intensity $I_F = 10 \text{ mA}$ $I_V$ (mcd)	Bestellnummer Ordering Code
LU H371-FJ	super-red / green	colorless clear	1.0 ... 8.0	Q62703-Q2050
LU H371-GK	super-red / green	partly diffused	1.6 ... 12.5	Q62703-Q2051

Streuung der Lichtstärke in einer Verpackungseinheit  $I_{V \max} / I_{V \min} \leq 2.0$ .<sup>1)</sup>

Streuung der Lichtstärke in einer LED  $I_{V \max} / I_{V \min} \leq 4.0$  (LU H371-FJ),  $\leq 2.0$  (LU H371-GK).

<sup>1)</sup> Bei MULTILED® bestimmt die Helligkeit des jeweils dunkleren Chips in einem Gehäuse die Helligkeitsgruppe der LED.

Luminous intensity ratio in one packaging unit  $I_{V \max} / I_{V \min} \leq 2.0$ .<sup>1)</sup>

Luminous intensity ratio in one LED  $I_{V \max} / I_{V \min} \leq 4.0$  (LU H371-FJ),  $\leq 2.0$  (LU H371-GK).

<sup>1)</sup> In case of MULTILED®, the brightness of the darker chip in one package determines the brightness group of the LED.

**Grenzwerte**  
**Maximum Ratings**

Bezeichnung Parameter	Symbol Symbol	Werte Values	Einheit Unit
Betriebstemperatur Operating temperature range	$T_{op}$	- 55... + 100	°C
Lagertemperatur Storage temperature range	$T_{stg}$	- 55... + 100	°C
Sperrschichttemperatur Junction temperature	$T_j$	+ 100	°C
Durchlaßstrom Forward current	$I_F$	40 <sup>1)</sup>	mA
Stoßstrom Surge current $t \leq 10 \mu s, D = 0.005$	$I_{FM}$	0.5 <sup>1)</sup>	A
Verlustleistung Power dissipation $T_A \leq 25^\circ C$	$P_{tot}$	140 <sup>1)</sup>	mW
Wärmewiderstand Thermal resistance Sperrschicht / Luft Junction / air	$R_{th JA}$	400	K/W

1) Bei gleichzeitigem Betrieb beider Dioden darf die Summe aus Strom und Verlustleistung die angegebene Grenze nicht überschreiten.

1) With simultaneous operation of both diodes the sum of the current and the power dissipation must not exceed the specified limits.

**Kennwerte** ( $T_A = 25^\circ\text{C}$ )

**Characteristics**

Bezeichnung Parameter	Symbol Symbol	Werte Values		Einheit Unit
		super-red	green	
Wellenlänge des emittierten Lichtes (typ.) Wavelength at peak emission (typ.) $I_F = 20\text{ mA}$	$\lambda_{\text{peak}}$	635	565	nm
Dominantwellenlänge (typ.) Dominant wavelength (typ.) $I_F = 20\text{ mA}$	$\lambda_{\text{dom}}$	628	570	nm
Spektrale Bandbreite bei 50% $I_{\text{rel max}}$ (typ.) Spectral bandwidth at 50% $I_{\text{rel max}}$ (typ.) $I_F = 20\text{ mA}$	$\Delta\lambda$	45	25	nm
Abstrahlwinkel bei 50% $I_V$ (Vollwinkel) Viewing angle at 50% $I_V$	$2\varphi$	100	100	Grad deg.
Durchlaßspannung (typ.) Forward voltage (max.) $I_F = 10\text{ mA}$	$V_F$ $V_F$	2.0 2.6	2.0 2.6	V V
Kapazität (typ.) Capacitance $V_R = 0\text{ V}, f = 1\text{ MHz}$	$C_O$	12	15	pF
Schaltzeiten: Switching times: $I_V$ from 10% to 90% (typ.) $I_V$ from 90% to 10% (typ.) $I_F = 100\text{ mA}, t_p = 10\text{ }\mu\text{s}, R_L = 50$	$t_r$ $t_f$	300 50	450 200	ns ns

**Relative spektrale Emission**  $I_{rel} = f(\lambda)$ ,  $T_A = 25^\circ\text{C}$ ,  $I_F = 20\text{ mA}$

**Relative spectral emission**

$V(\lambda)$  = spektrale Augenempfindlichkeit

Standard eye response curve

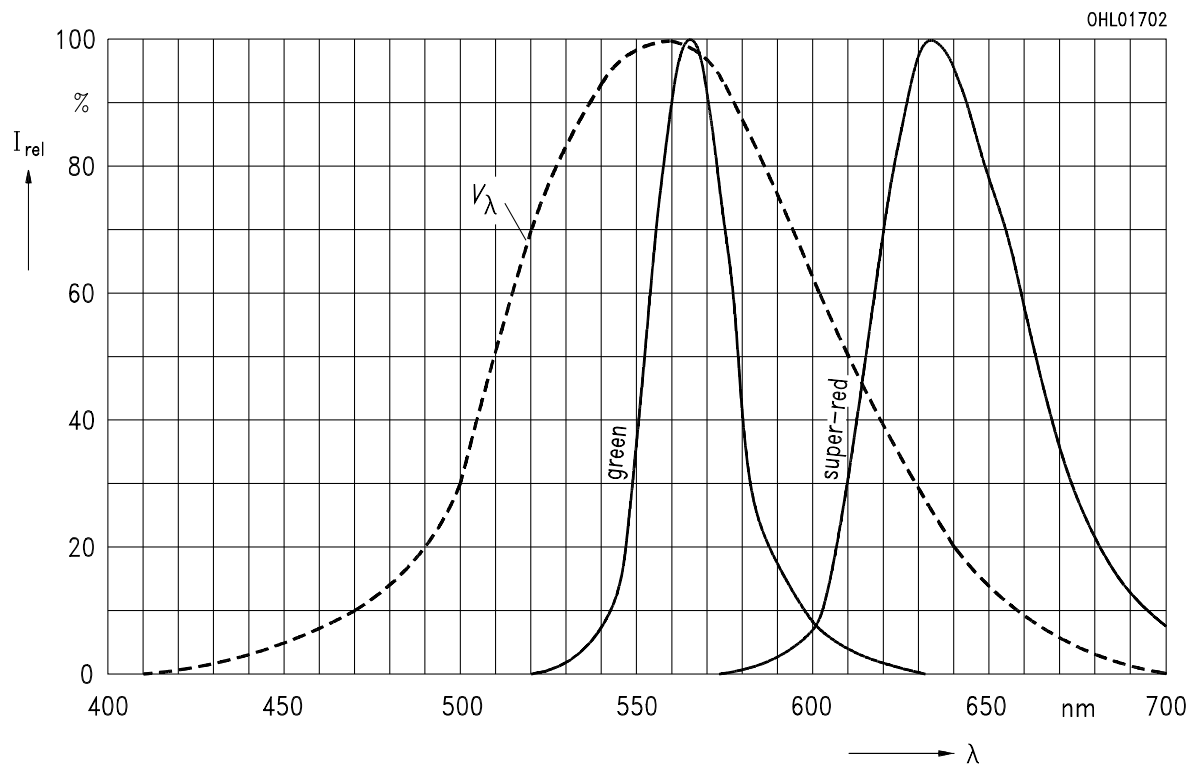

**Abstrahlcharakteristic**  $I_{rel} = f(\varphi)$

**Radiation characteristic**

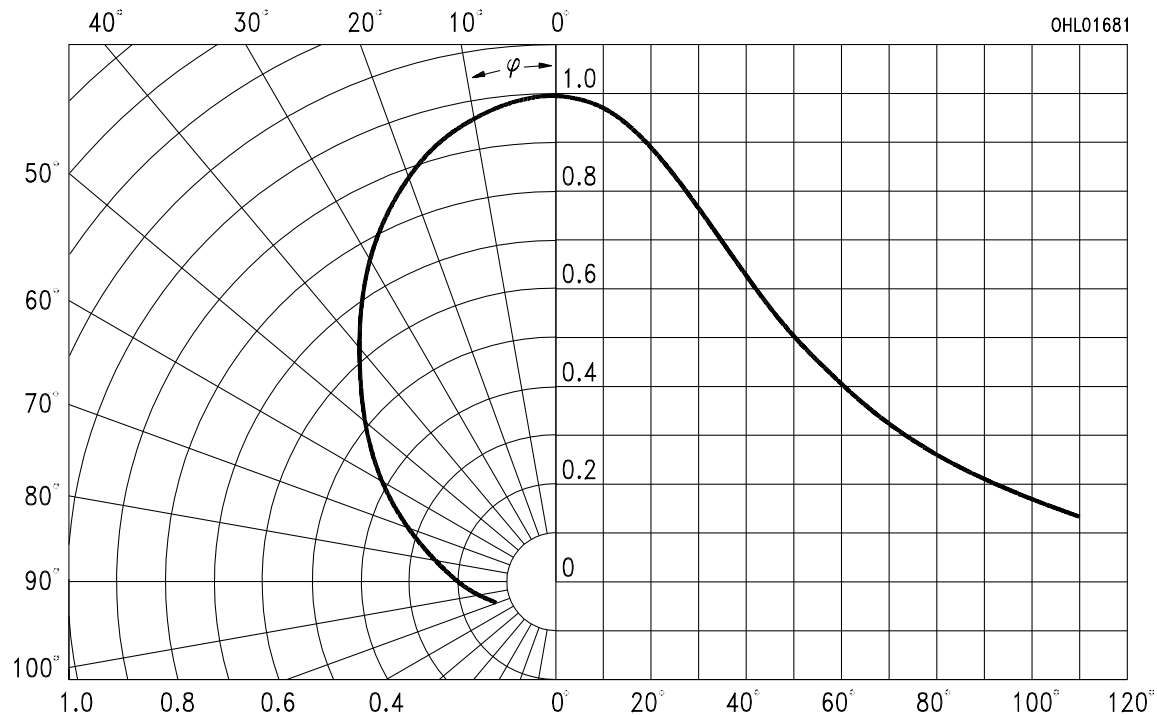

**Durchlaßstrom  $I_F = f(V_F)$**   
**Forward current**

$T_A = 25^\circ\text{C}$

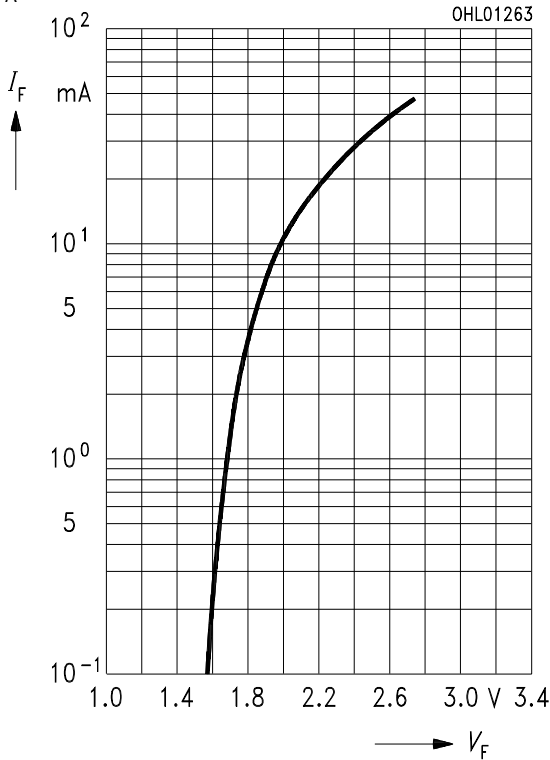

**Relative Lichtstärke  $I_V/I_{V(10\text{ mA})} = f(I_F)$**   
**Relative luminous intensity**

$T_A = 25^\circ\text{C}$

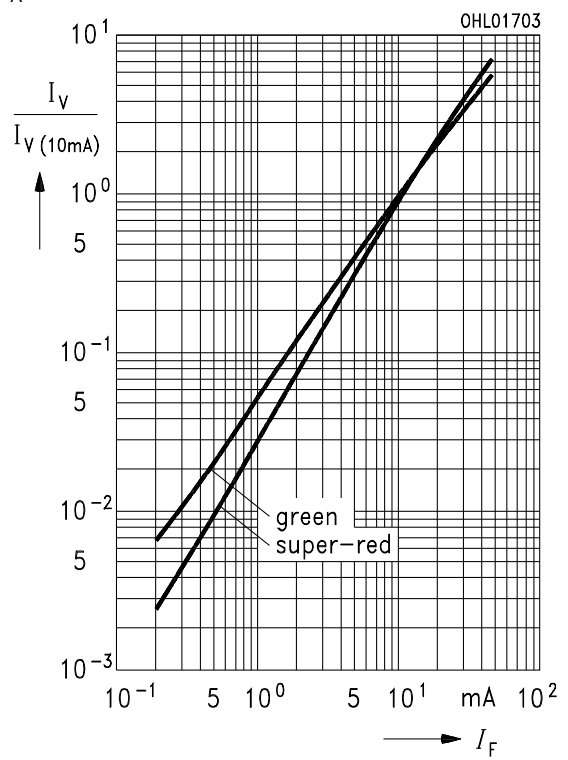

**Zulässige Impulsbelastbarkeit  $I_F = f(t_p)$**   
**Permissible pulse handling capability**  
 Duty cycle  $D =$  parameter,  $T_A = 25^\circ\text{C}$

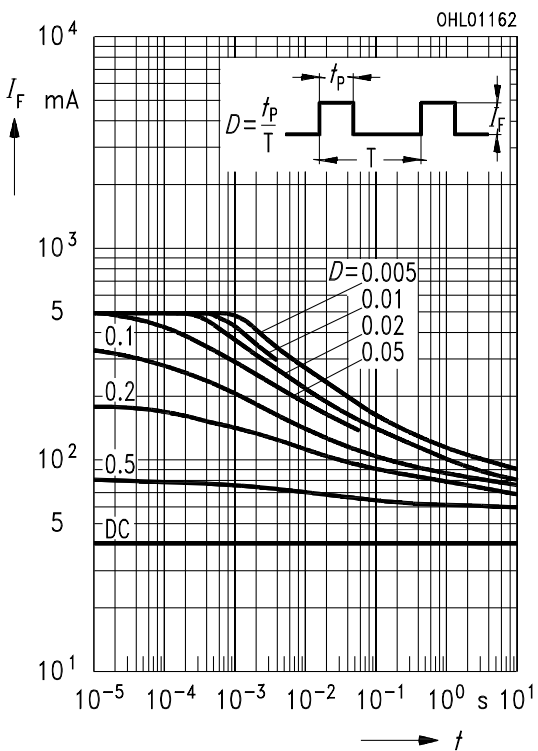

**Maximal zulässiger Durchlaßstrom**  
**Max. permissible forward current**  
 $I_F = f(T_A)$

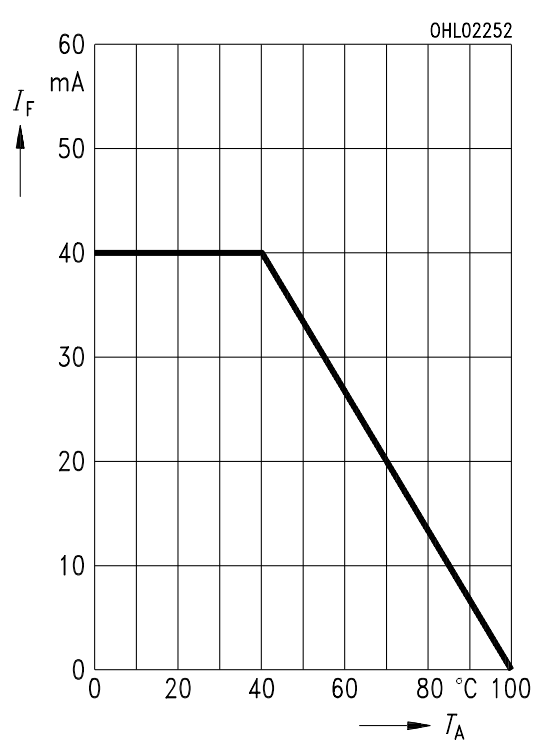

**Wellenlänge der Strahlung  $\lambda_{\text{peak}} = f(T_A)$**   
**Wavelength at peak emission**

$I_F = 20 \text{ mA}$

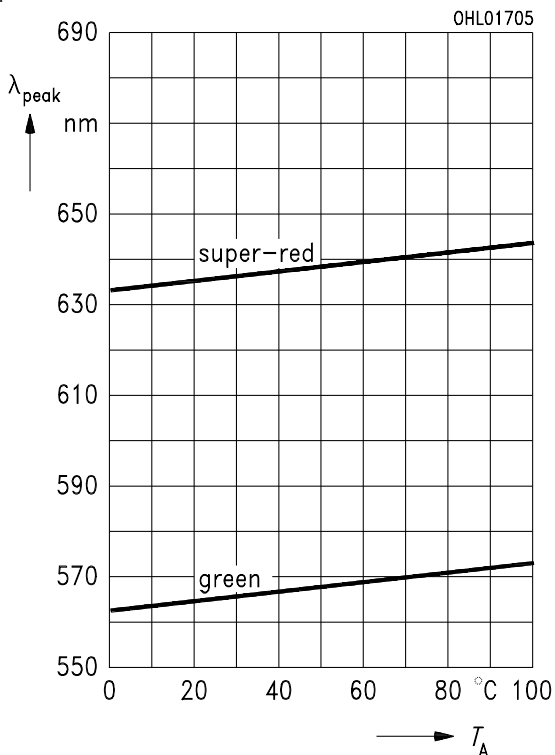

**Dominantwellenlänge  $\lambda_{\text{dom}} = f(T_A)$**   
**Relative luminous intensity**

$I_F = 20 \text{ mA}$

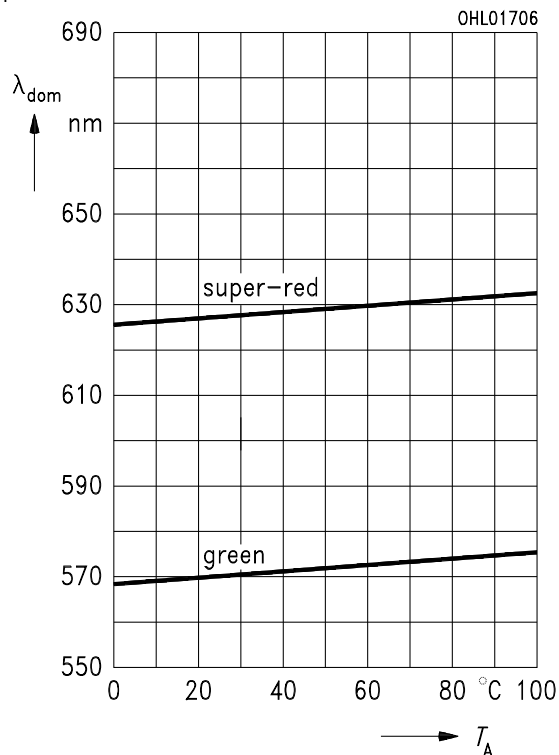

**Durchlaßspannung  $V_F = f(T_A)$**   
**Forward voltage**

$I_F = 10 \text{ mA}$

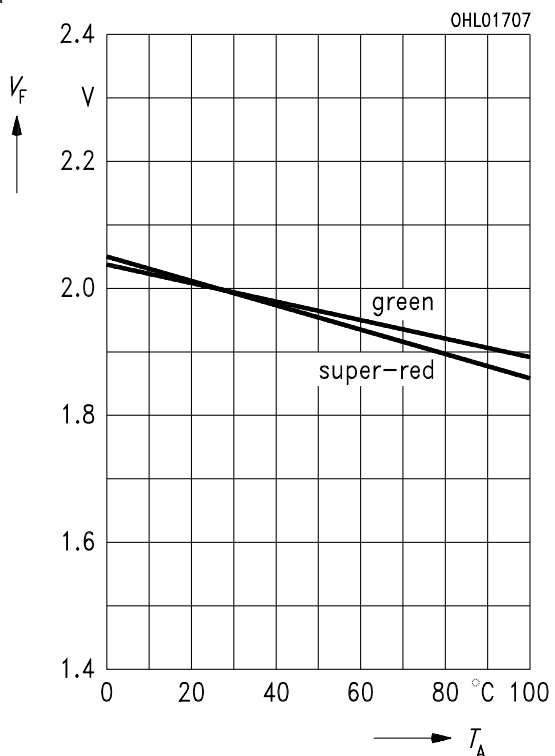

**Relative Lichtstärke  $I_V / I_{V(25^{\circ}\text{C})} = f(T_A)$**   
**Relative luminous intensity**

$I_F = 10 \text{ mA}$

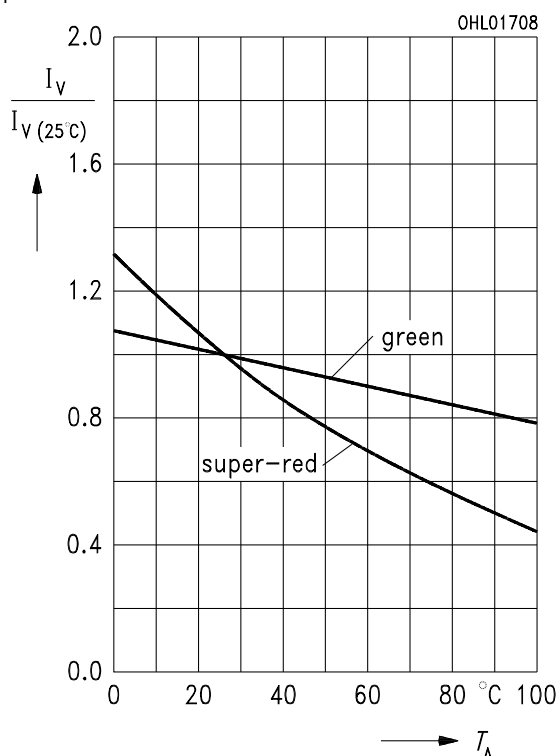

**Maßzeichnung** (Maße in mm, wenn nicht anders angegeben)  
**Package Outlines** (Dimensions in mm, unless otherwise specified)

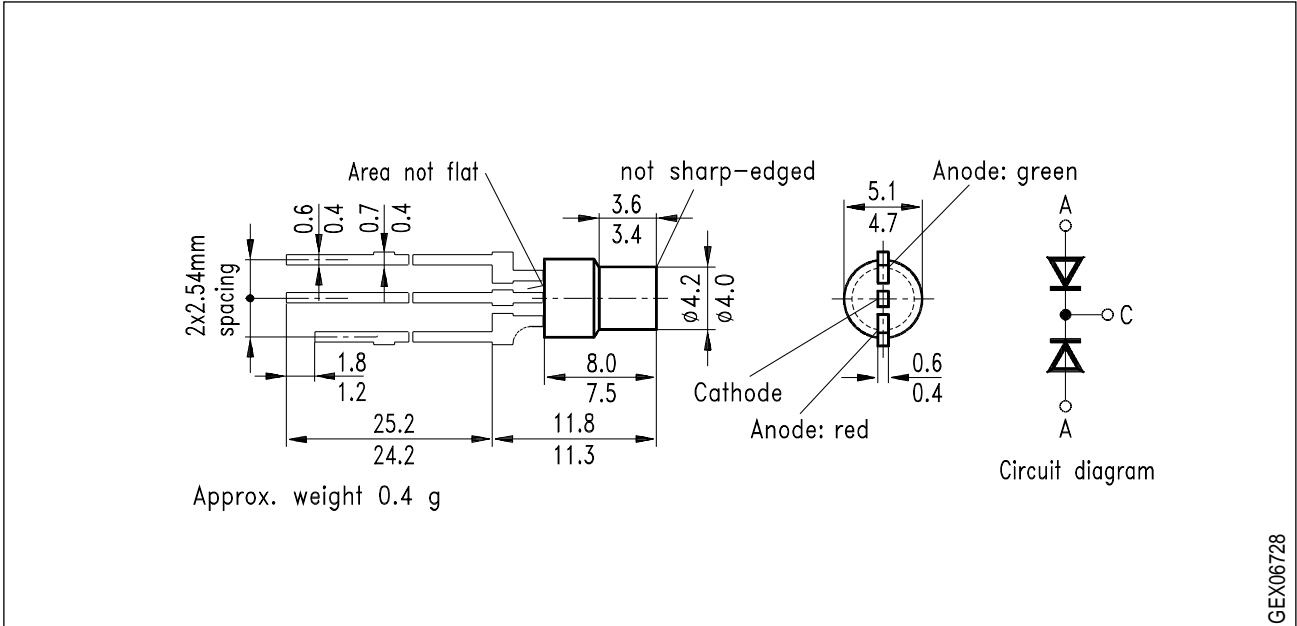

**Kathodenkennzeichnung:** Mittlerer Lötspieß  
**Cathode mark:** Middle solder lead