

## NPN Silicon AF Transistors

**BCX 68**

- For general AF applications
- High collector current
- High current gain
- Low collector-emitter saturation voltage
- Complementary type: BCX 69 (PNP)

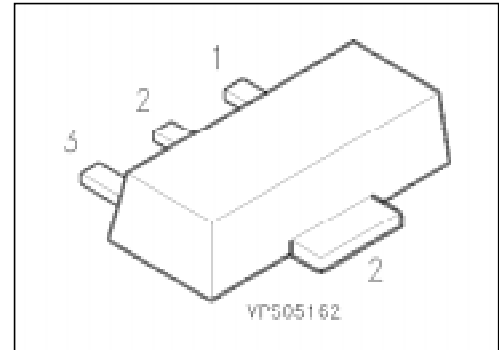

Type	Marking	Ordering Code (tape and reel)	Pin Configuration			Package <sup>1)</sup>
			1	2	3	
BCX 68	–	Q62702-C1572	B	C	E	SOT-89
BCX 68-10	CB	Q62702-C1864				
BCX 68-16	CC	Q62702-C1865				
BCX 68-25	CD	Q62702-C1866				

### Maximum Ratings

Parameter	Symbol	Values	Unit
Collector-emitter voltage	$V_{CE0}$	20	V
Collector-base voltage	$V_{CB0}$	25	
Emitter-base voltage	$V_{EB0}$	5	
Collector current	$I_C$	1	A
Peak collector current	$I_{CM}$	2	
Base current	$I_B$	100	mA
Peak base current	$I_{BM}$	200	
Total power dissipation, $T_s = 130\text{ °C}$	$P_{tot}$	1	W
Junction temperature	$T_j$	150	°C
Storage temperature range	$T_{stg}$	– 65 ... + 150	

### Thermal Resistance

Junction - ambient <sup>2)</sup>	$R_{th\ JA}$	≤ 75	K/W
Junction - soldering point	$R_{th\ JS}$	≤ 20	

<sup>1)</sup> For detailed information see chapter Package Outlines.

<sup>2)</sup> Package mounted on epoxy pcb 40 mm × 40 mm × 1.5 mm/6 cm<sup>2</sup> Cu.

## Electrical Characteristics

at  $T_A = 25\text{ }^\circ\text{C}$ , unless otherwise specified.

Parameter	Symbol	Values			Unit
		min.	typ.	max.	

### DC characteristics

Collector-emitter breakdown voltage $I_C = 30\text{ mA}$	$V_{(BR)CE0}$	20	–	–	V
Collector-base breakdown voltage $I_C = 10\text{ }\mu\text{A}$	$V_{(BR)CB0}$	25	–	–	
Emitter-base breakdown voltage $I_E = 1\text{ }\mu\text{A}$	$V_{(BR)EB0}$	5	–	–	
Collector cutoff current $V_{CB} = 25\text{ V}$ $V_{CB} = 25\text{ V}, T_A = 150\text{ }^\circ\text{C}$	$I_{CB0}$	–	–	100	nA
Emitter cutoff current $V_{EB} = 5\text{ V}$	$I_{EB0}$	–	–	10	$\mu\text{A}$
DC current gain <sup>1)</sup> $I_C = 5\text{ mA}, V_{CE} = 10\text{ V}$ $I_C = 500\text{ mA}, V_{CE} = 1\text{ V}$	$h_{FE}$	50	–	–	–
BCX 68		85	–	375	
BCX 68-10		85	100	160	
BCX 68-16		100	160	250	
BCX 68-25		160	250	375	
$I_C = 1\text{ A}, V_{CE} = 1\text{ V}$		60	–	–	
Collector-emitter saturation voltage <sup>1)</sup> $I_C = 1\text{ A}, I_B = 100\text{ mA}$	$V_{CEsat}$	–	–	0.5	V
Base-emitter voltage <sup>1)</sup> $I_C = 5\text{ mA}, V_{CE} = 10\text{ V}$ $I_C = 1\text{ A}, V_{CE} = 1\text{ V}$	$V_{BE}$	–	0.6	–	
		–	–	1	

### AC characteristics

Transition frequency $I_C = 100\text{ mA}, V_{CE} = 5\text{ V}, f = 20\text{ MHz}$	$f_T$	–	100	–	MHz
---	-------	---	-----	---	-----

<sup>1)</sup> Pulse test:  $t \leq 300\text{ }\mu\text{s}, D = 2\text{ }%$ .

**Total power dissipation  $P_{tot} = f(T_A^*; T_S)$**

\* Package mounted on epoxy

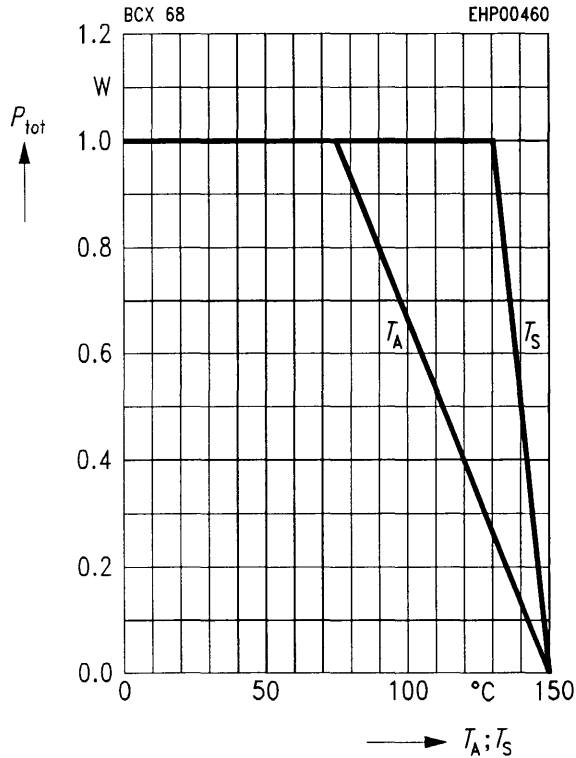

**Collector current  $I_C = f(V_{BE})$**

$V_{CE} = 1 \text{ V}$

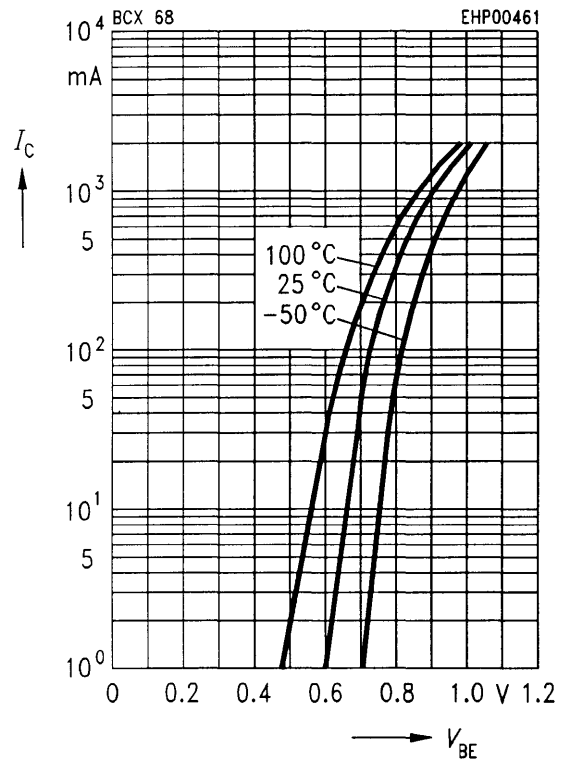

**Permissible pulse load  $P_{tot \text{ max}}/P_{tot \text{ DC}} = f(t_p)$**

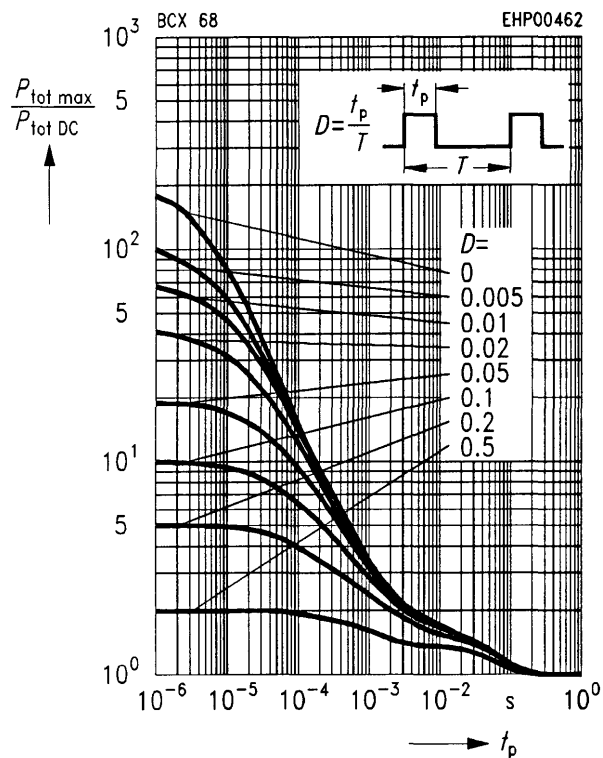

**Transition frequency  $f_T = f(I_C)$**

$V_{CE} = 5 \text{ V}$

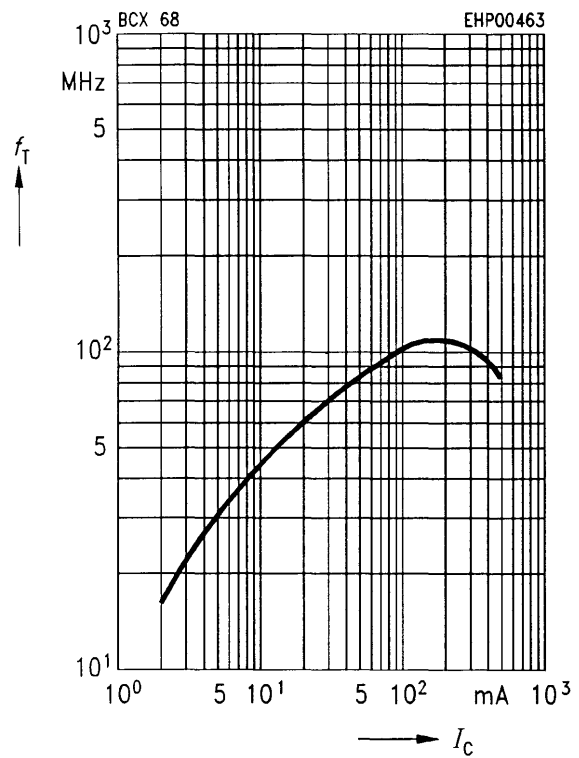

**DC current gain  $h_{FE} = f(I_C)$**

$V_{CE} = 1 \text{ V}$

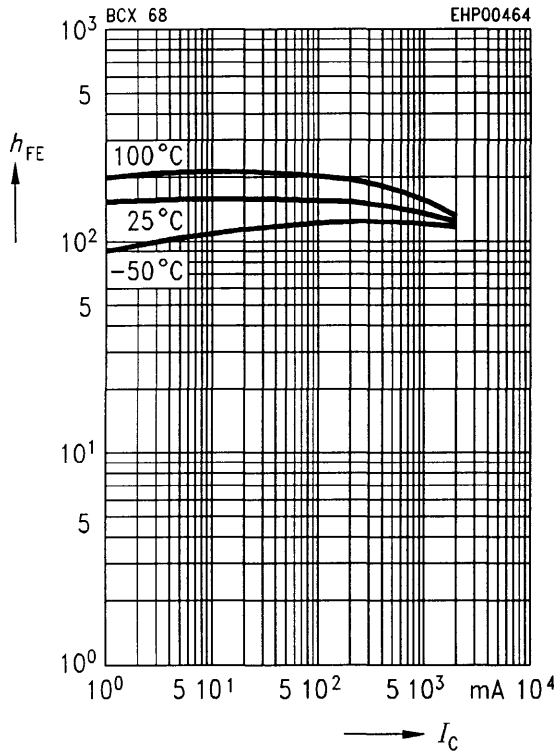

**Collector-emitter saturation voltage  $I_C = f(V_{CEsat})$**

$I_C = f(V_{CEsat})$

$h_{FE} = 10$

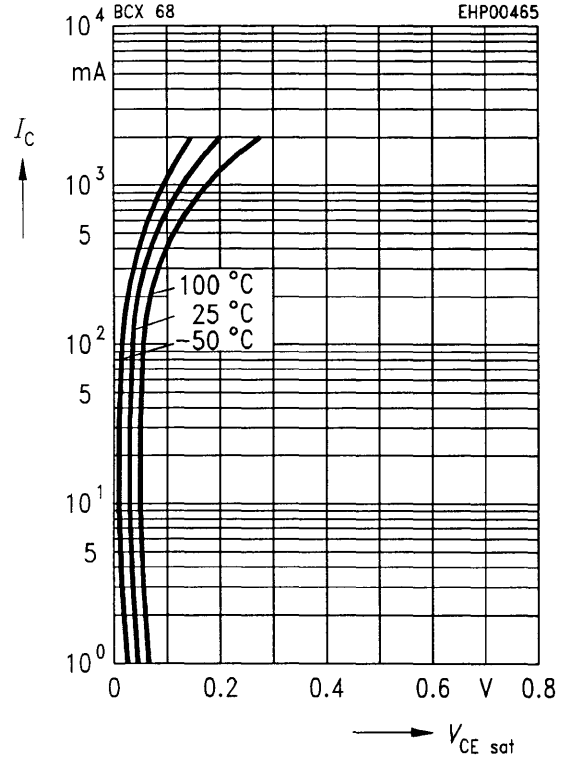

**Collector cutoff current  $I_{CB0} = f(T_A)$**

$V_{CB} = 25 \text{ V}$

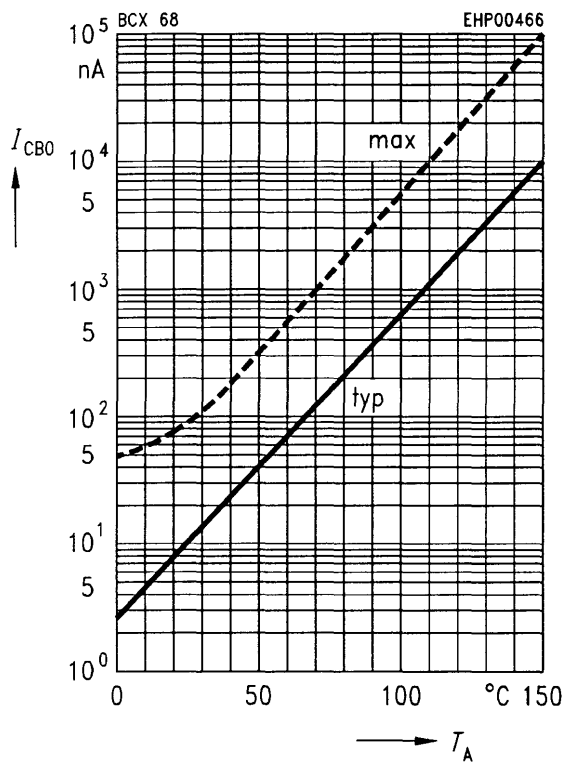

**Base-emitter saturation voltage  $I_C = f(V_{BEsat})$**

$I_C = f(V_{BEsat})$

$h_{FE} = 10$

