

# SHINDENGEN

## Schottky Rectifiers (SBD)

Single

# D3FS4A

## 40V 2.6A

### FEATURES

- Small SMT
- Tj150
- Low  $V_F=0.45V$
- $P_{RRSM}$  avalanche guaranteed

### APPLICATION

- Switching power supply
- DC/DC converter
- Home Appliances, Office Equipment
- Telecommunication

### OUTLINE DIMENSIONS

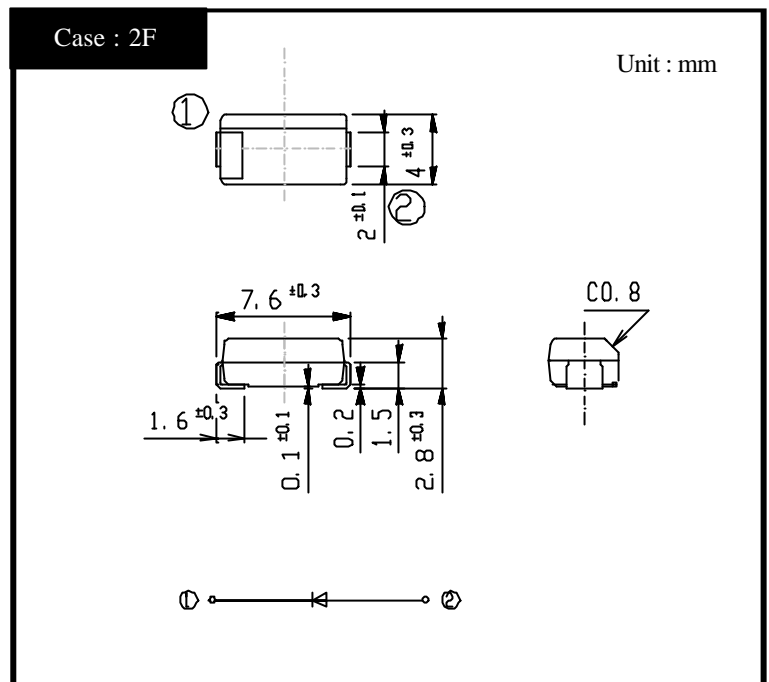

### RATINGS

Absolute Maximum Ratings (If not specified  $T_I=25$  )

Item	Symbol	Conditions	Ratings	Unit
Storage Temperature	$T_{stg}$		-55 ~ 150	
Operating Junction Temperature	$T_j$		150	
Maximum Reverse Voltage	$V_{RM}$		40	V
Repetitive Peak Surge Reverse Voltage	$V_{RRSM}$	Pulse width 0.5ms, duty 1/40	45	V
Average Rectified Forward Current	$I_O$	50Hz sine wave, R-load $T_a=34$ On alumina substrate	2.6	A
		50Hz sine wave, R-load $T_a=30$ On glass-epoxy substrate	1.9	
Peak Surge Forward Current	$I_{FSM}$	50Hz sine wave, Non-repetitive 1 cycle peak value, $T_j=125$	150	A
Repetitive Peak Surge Reverse Power	$P_{RRSM}$	Pulse width 10 $\mu$ s, $T_j=25$	330	W

Electrical Characteristics (If not specified  $T_I=25$  )

Item	Symbol	Conditions	Ratings	Unit
Forward Voltage	$V_F$	$I_F=2.6A$ , Pulse measurement	Max.0.45	V
Reverse Current	$I_R$	$V_R=V_{RM}$ , Pulse measurement	Max.5	mA
Junction Capacitance	$C_j$	$f=1MHz$ , $V_R=10V$	Typ.340	pF
Thermal Resistance	$\theta_{jl}$	junction to lead	Max.23	/W
	$\theta_{ja}$	junction to ambient On alumina substrate	Max.80	
		junction to ambient On glass-epoxy substrate	Max.115	

# D3FS4A

## Forward Voltage

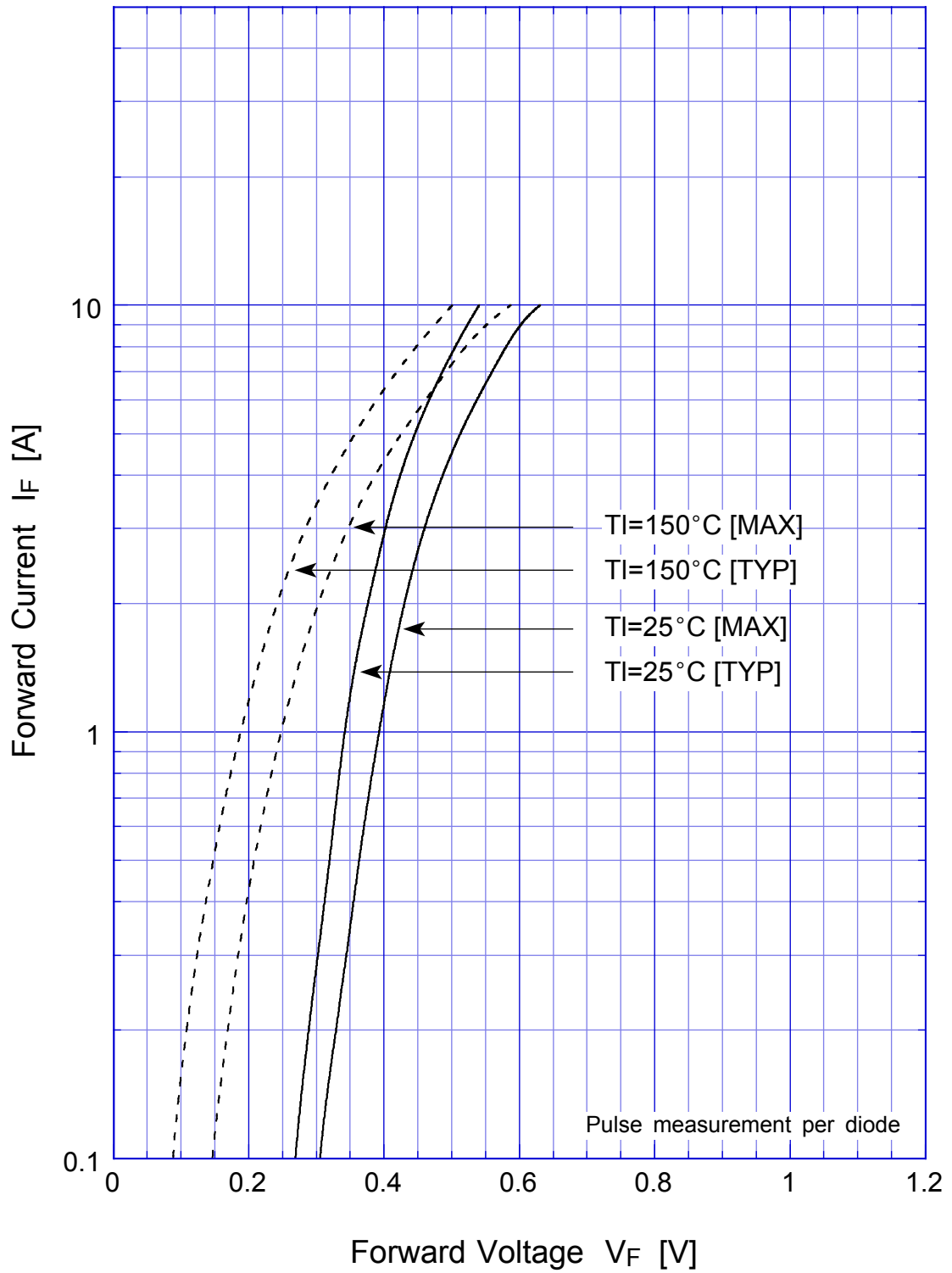

# D3FS4A

## Junction Capacitance

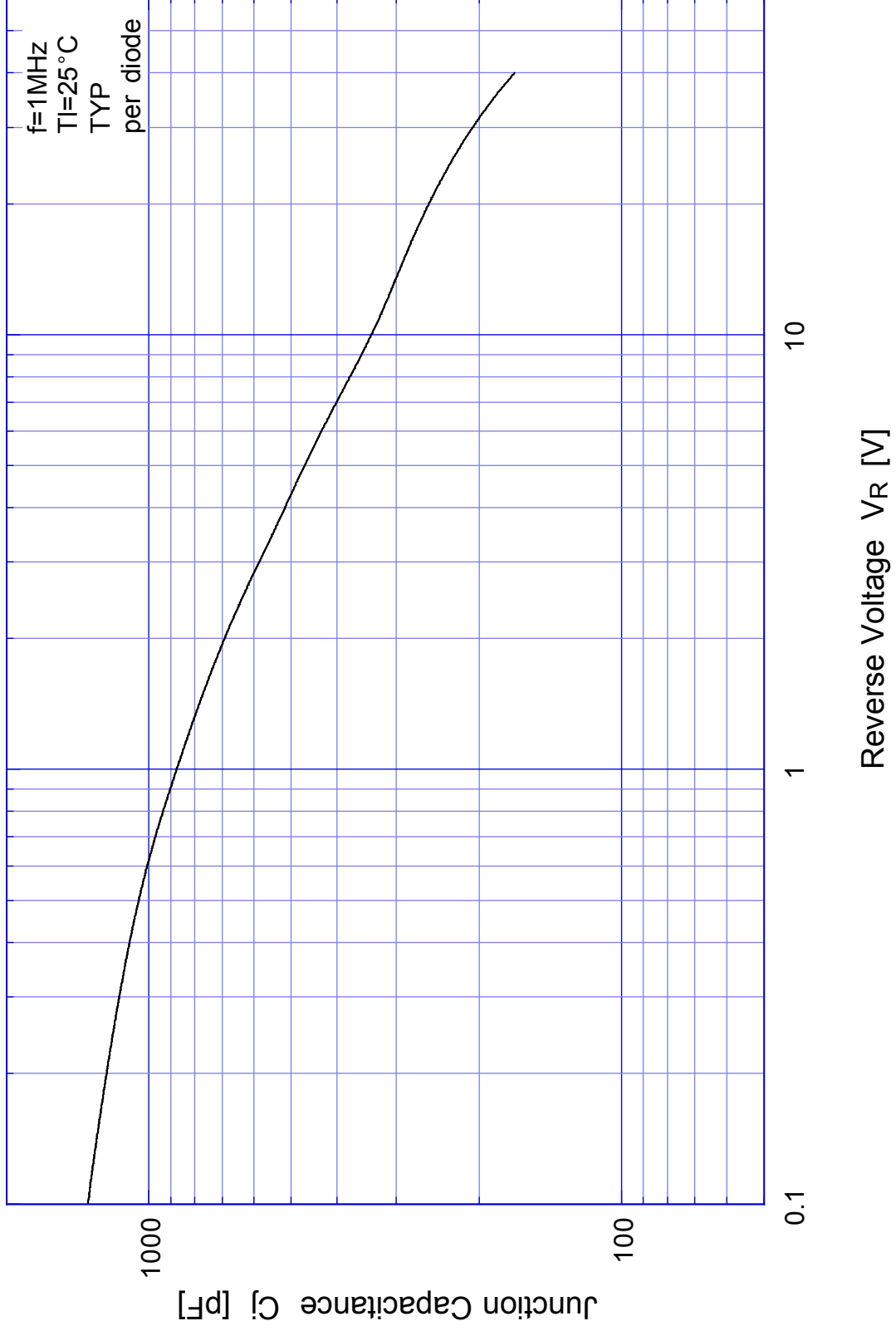

# D3FS4A

## Reverse Current

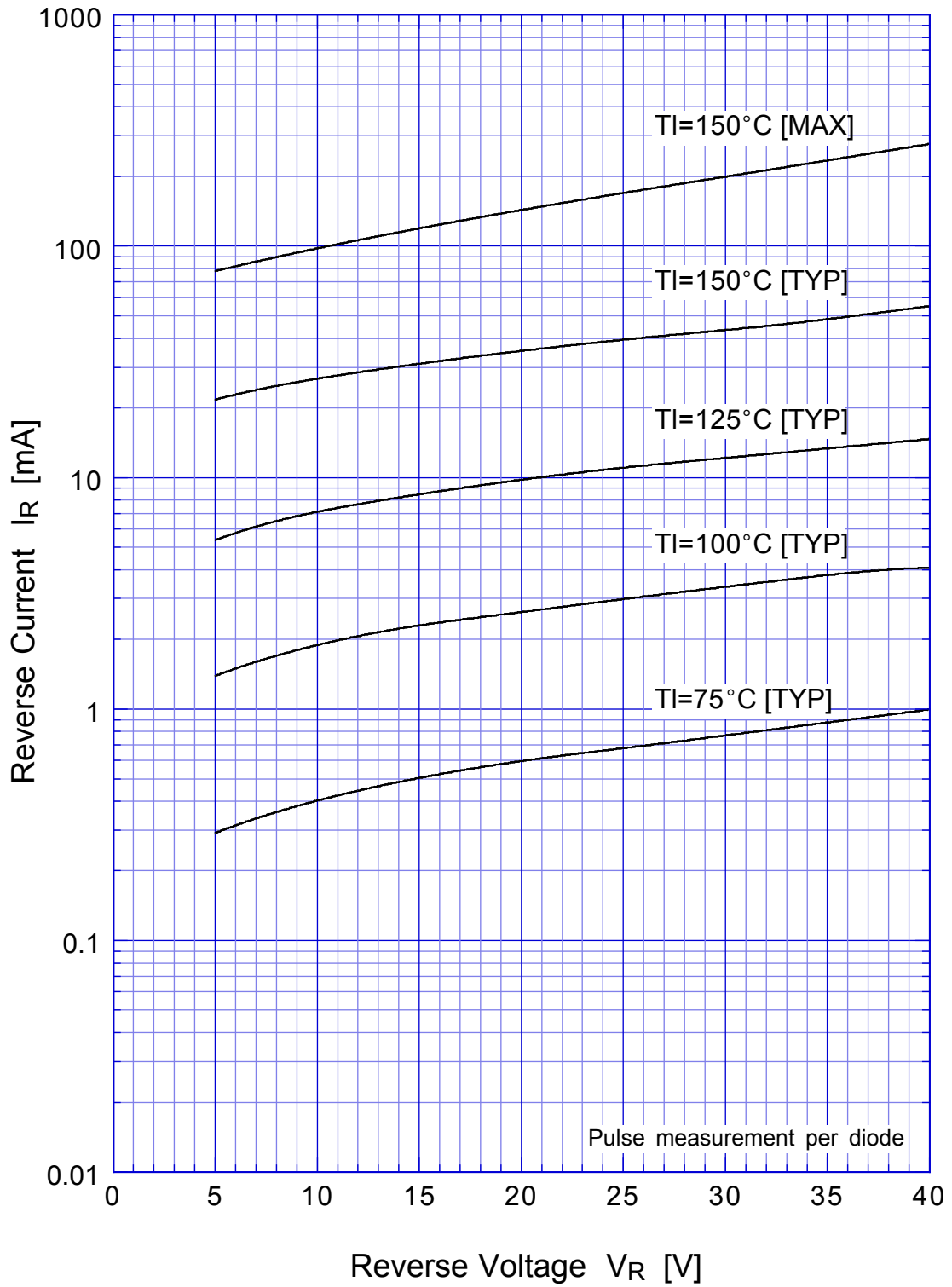

# D3FS4A Reverse Power Dissipation

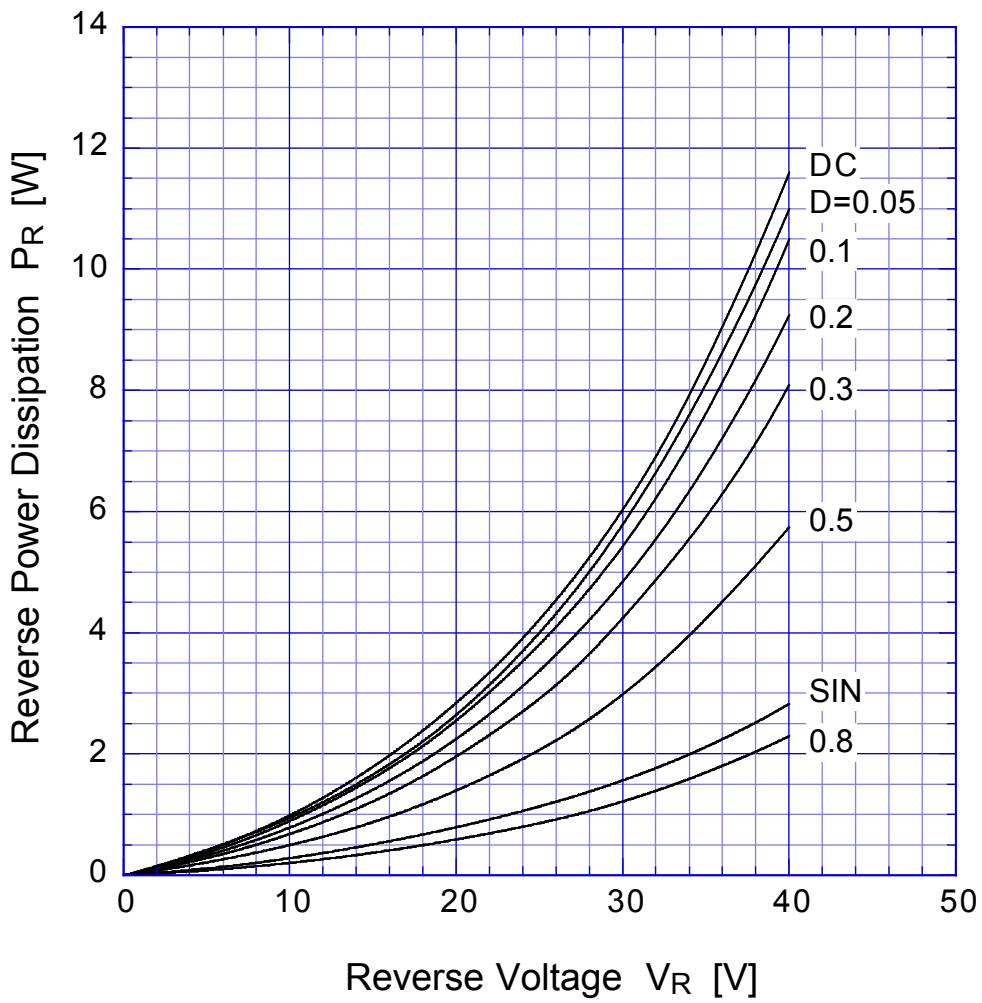

$T_j = 150^\circ\text{C}$

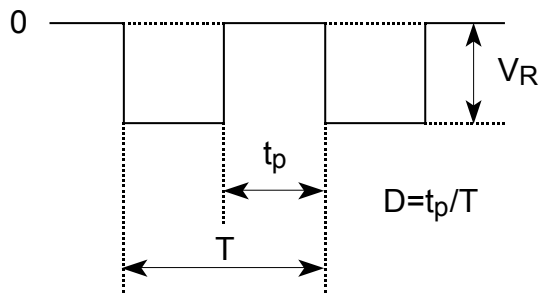

# D3FS4A Forward Power Dissipation

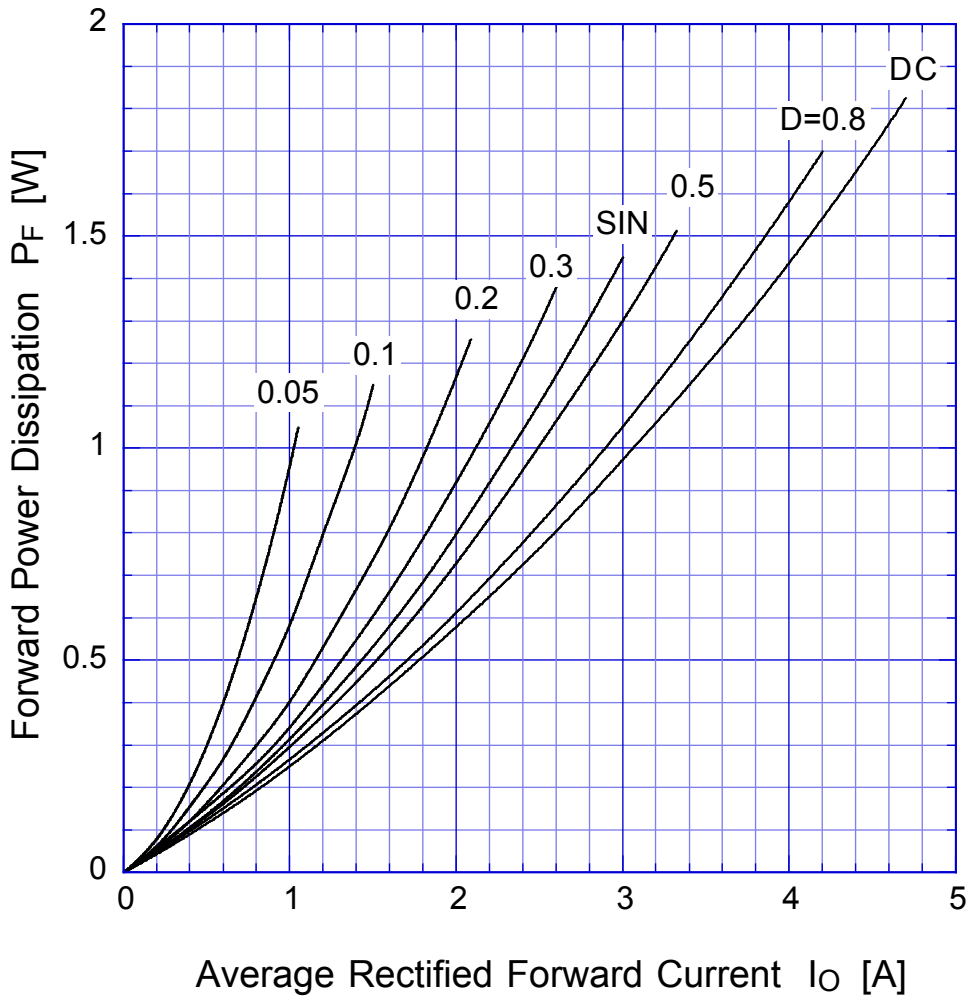

$T_j = 150^\circ\text{C}$

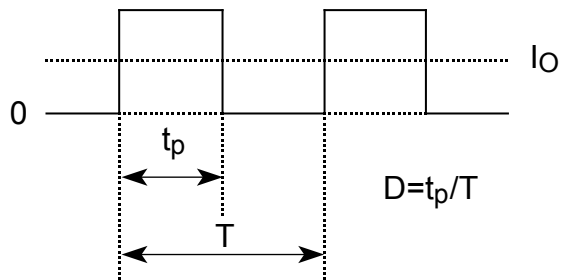

# D3FS4A

# Derating Curve

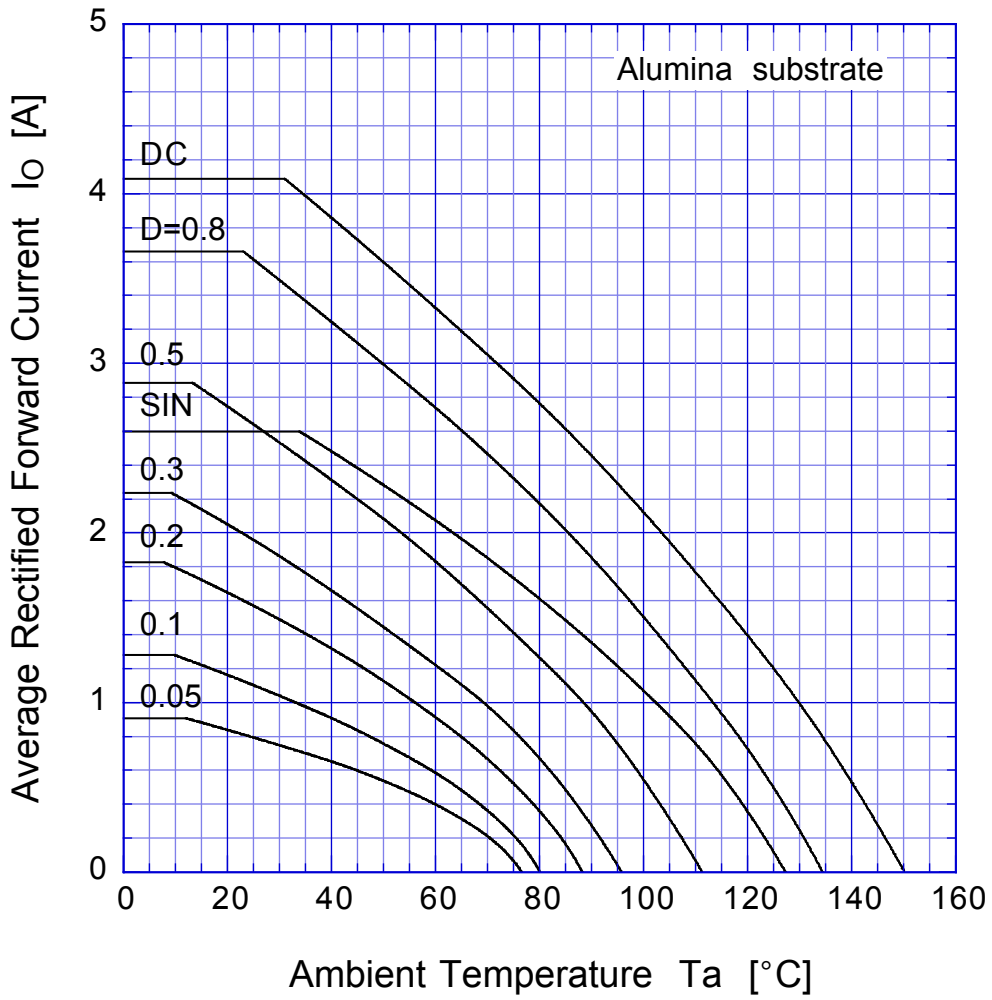

$V_R = 10V$



# D3FS4A

# Derating Curve

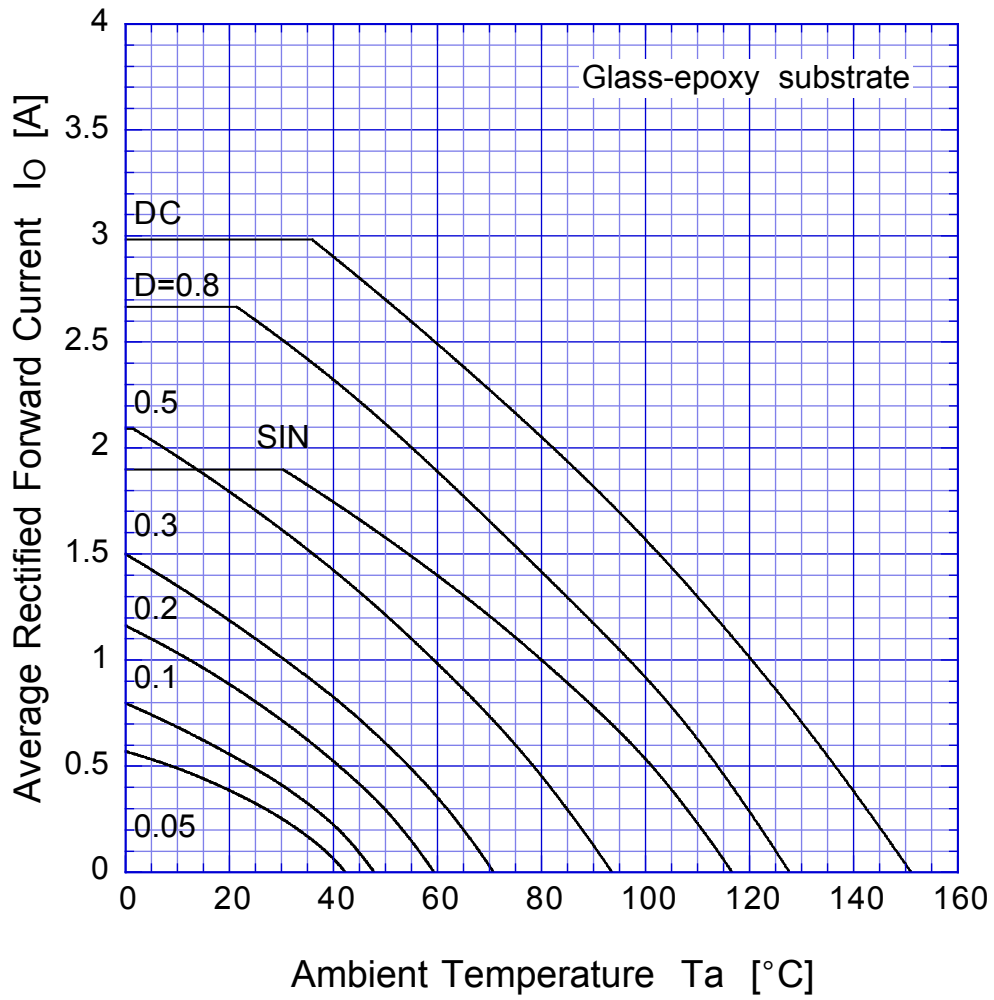

$V_R = 10V$

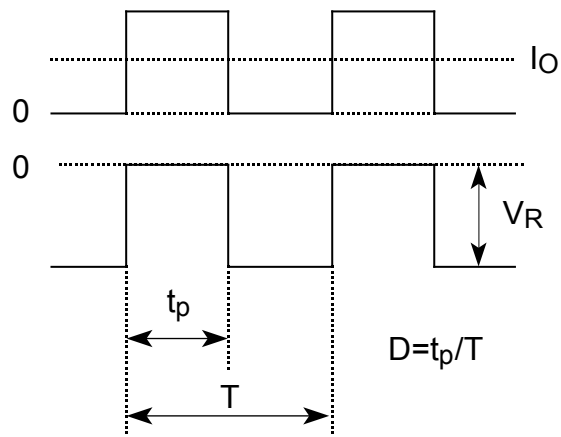



# D3FS4A

## Peak Surge Forward Capability

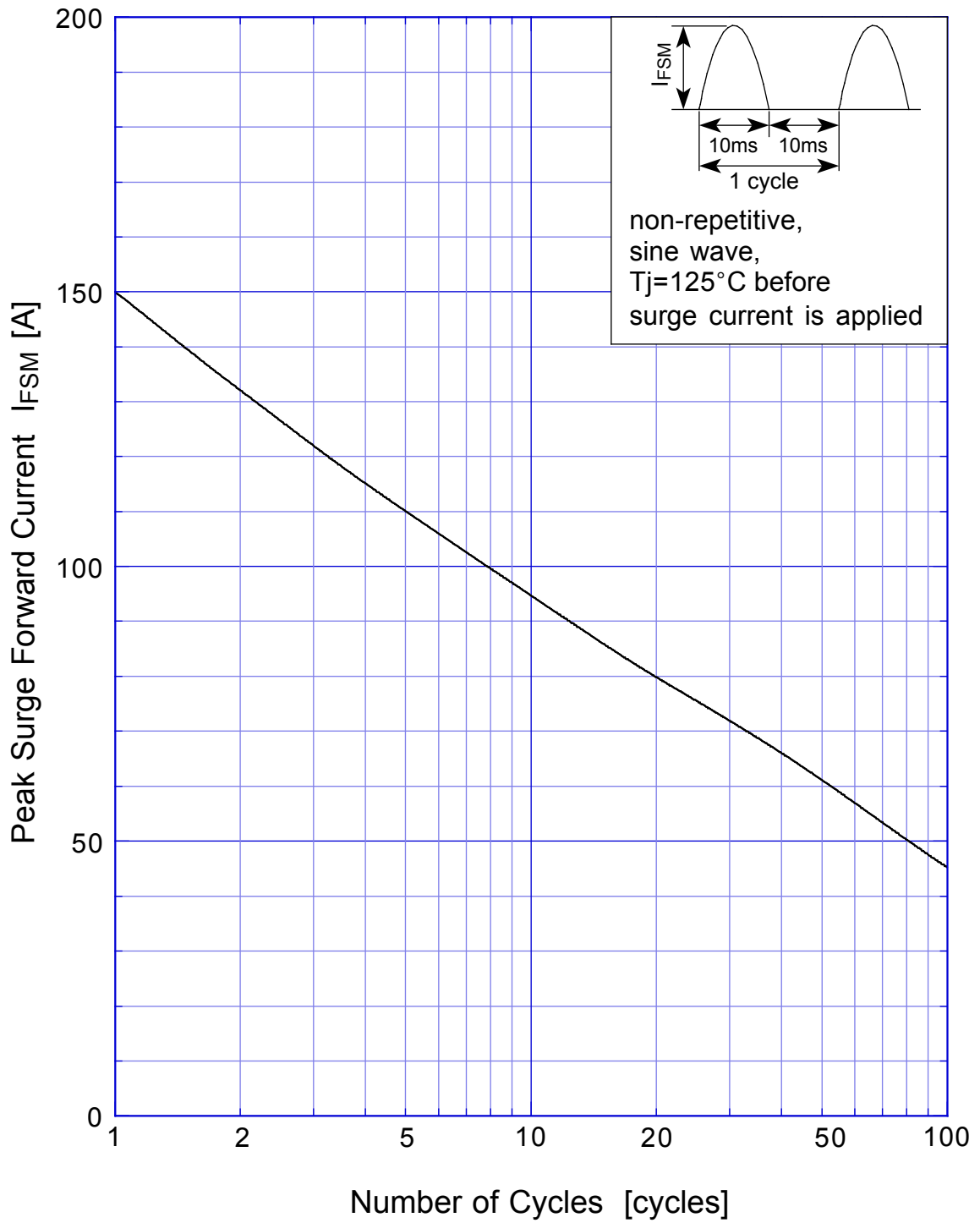

# SBD Repetitive Surge Reverse Power Derating Curve

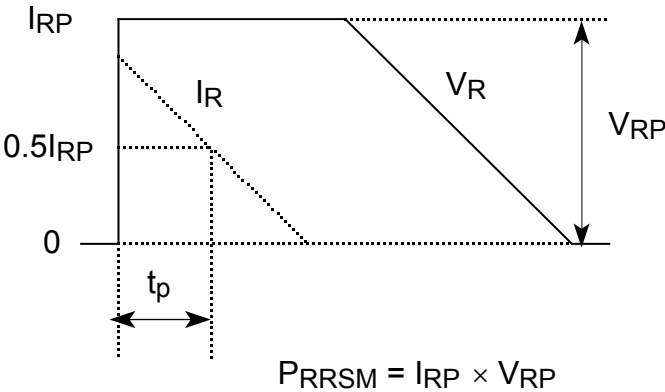
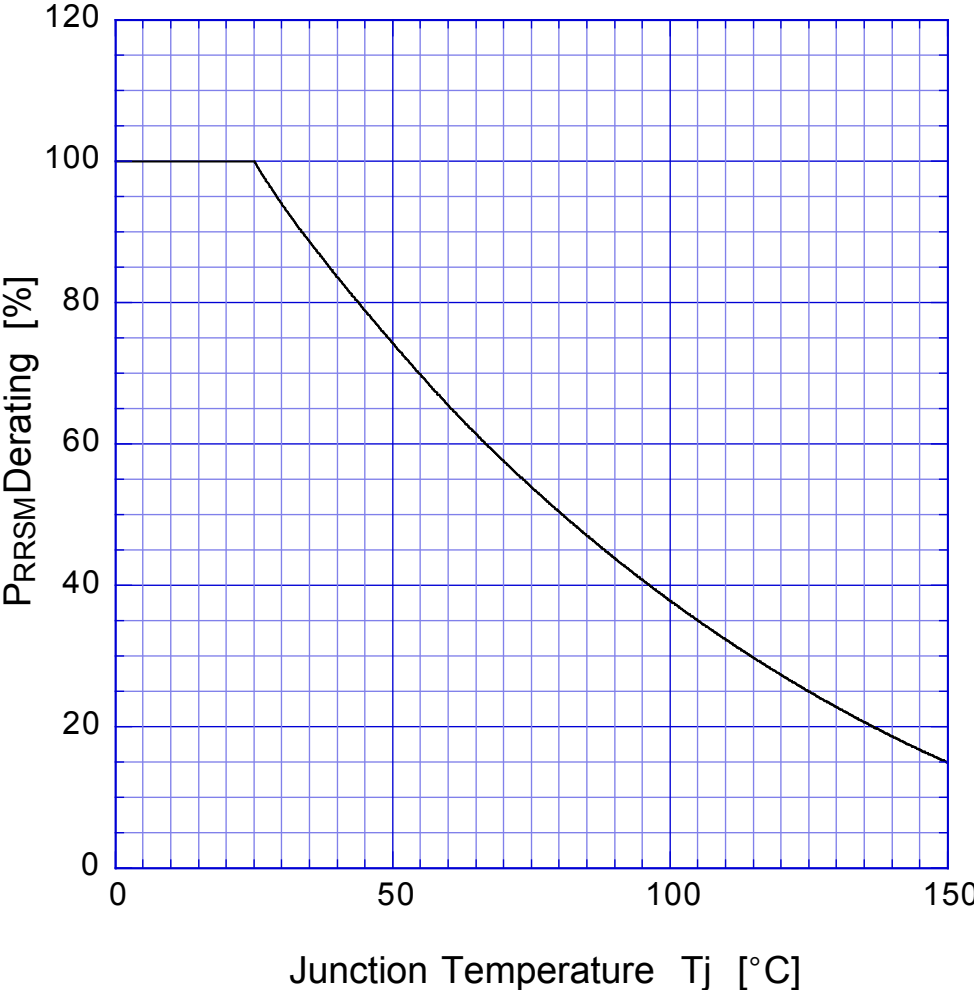

# SBD

## Repetitive Surge Reverse Power Capability

