

LR38616

Timing Generator IC for 2 140 k-pixel CCDs

DESCRIPTION

The LR38616 is a CMOS timing generator IC which generates timing pulses for driving 2 140 k-pixel CCD area sensors and processing pulses.

FEATURES

- Designed for 1/2-type 2 140 k-pixel CCD area sensors
- Frequency of driving horizontal CCD : 17.987 MHz
- Both double speed drive monitoring mode and still mode are possible
- Two still mode types :
3 fields period and 4 fields period
- External shutter control function with serial data input is possible
- +3 V and +4.5 V power supplies
- Package :
48-pin QFP (QFP048-P-0707) 0.5 mm pin-pitch



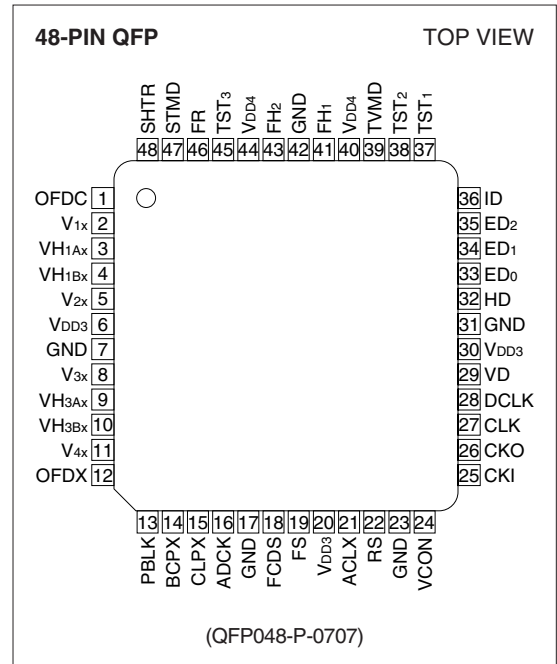

PIN CONNECTIONS

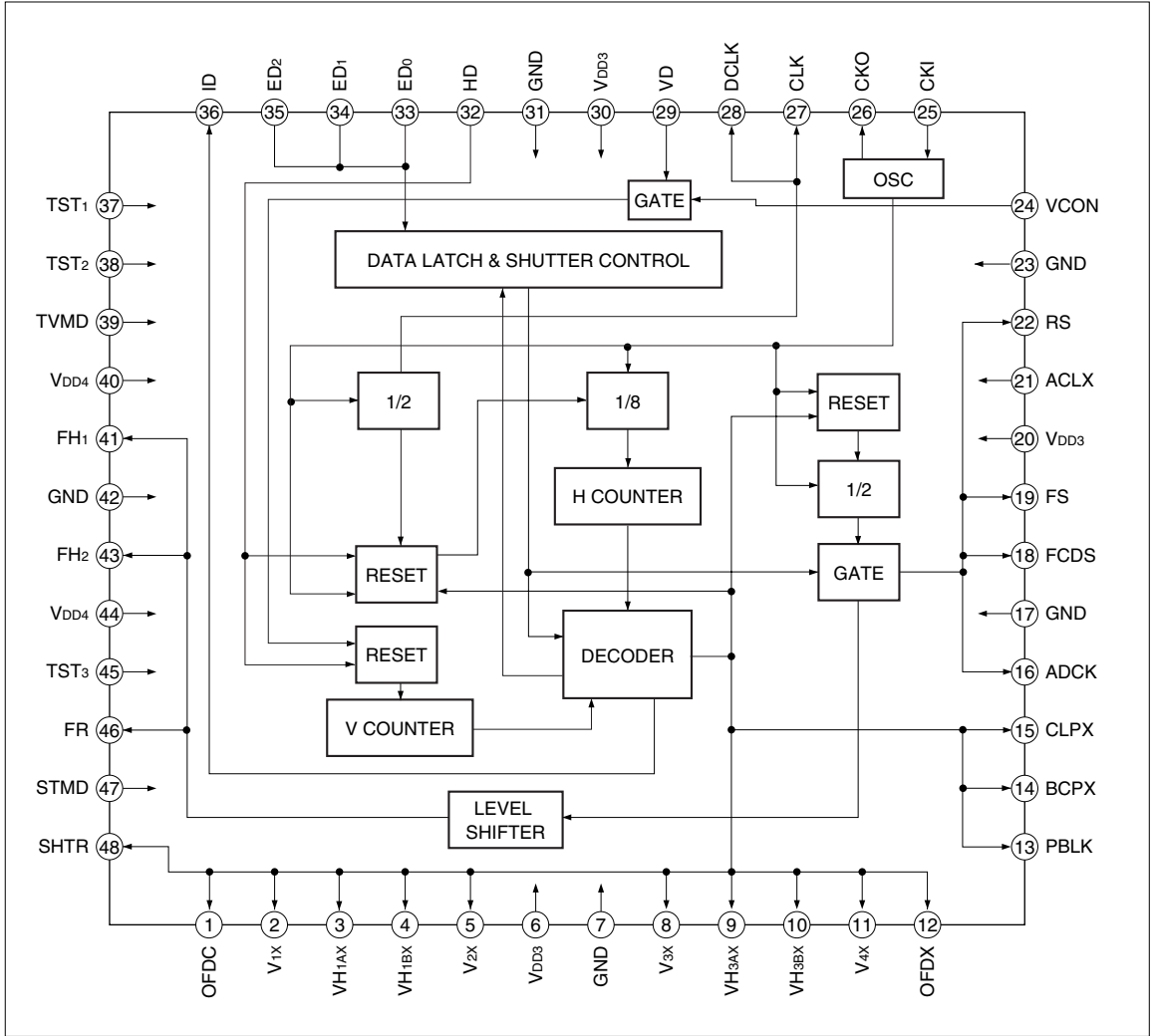













BLOCK DIAGRAM



PIN DESCRIPTION

PIN NO.	SYMBOL	I/O	POLARITY	PIN NAME	DESCRIPTION
1	OFDC	O3		Control pulse output for OFD voltage	A pulse to control OFD voltage.
2	V1X	O3		Vertical transfer pulse output 1	A vertical transfer pulse for CCD. Connect to V1X pin of vertical driver IC.
3	VH1AX	O3		Readout pulse output 1A	A pulse that transfers the charge of the photo-diode to the vertical shift register. Connect to VH1AX pin of vertical driver IC.
4	VH1BX	O3		Readout pulse output 1B	A pulse that transfers the charge of the photo-diode to the vertical shift register. Connect to VH1BX pin of vertical driver IC.
5	V2X	O3		Vertical transfer pulse output 2	A vertical transfer pulse for CCD. Connect to V2X pin of vertical driver IC.
6	VDD3	-	-	Power supply	Supply of +3.3 V power.
7	GND	-	-	Ground	A grounding pin.
8	V3X	O3		Vertical transfer pulse output 3	A vertical transfer pulse for CCD. Connect to V3X pin of vertical driver IC.
9	VH3AX	O3		Readout pulse output 3A	A pulse that transfers the charge of the photo-diode to the vertical shift register. Connect to VH3AX pin of vertical driver IC.
10	VH3BX	O3		Readout pulse output 3B	A pulse that transfers the charge of the photo-diode to the vertical shift register. Connect to VH3BX pin of vertical driver IC.
11	V4X	O3		Vertical transfer pulse output 4	A vertical transfer pulse for CCD. Connect to V4X pin of vertical driver IC.
12	OFDX	O3		OFD pulse output	A pulse that sweeps the charge of the photo-diode for the electronic shutter. Connect to OFD pin of CCD through the vertical driver IC and DC offset circuit. Held at H level at normal mode.
13	PBLK	O3		Pre-blanking pulse output	A pulse that corresponds to the cease period of the horizontal transfer pulse.
14	BCPX	O3		Optical black clamp pulse output	A pulse to clamp the optical black signal. This pulse stays high during the absence of effective pixels within the vertical blanking or the period of sweep-out signal.
15	CLPX	O3		Clamp pulse output	A pulse to clamp the dummy outputs of CCD signal. This pulse stays high during the sweep-out period.
16	ADCK	O6MA3		AD clock output	An output pin for AD converter. The output phase of ADCK is selected by serial data step by 90°.
17	GND	-	-	Ground	A grounding pin.

PIN NO.	SYMBOL	I/O	POLARITY	PIN NAME	DESCRIPTION
18	FCDS	O6MA3		CDS pulse output 1	A pulse to clamp the feed-through level from CCD. The output phase of FCDS is selected by serial data.
19	FS	O6MA3		CDS pulse output 2	A pulse to sample-hold the signal from CCD. The output phase of FS is selected by serial data.
20	VDD3	–	–	Power supply	Supply of +3.3 V power.
21	ACLX	ICU3	–	All clear input	An input pin for resetting all internal circuits at power on. Connect to VDD through the diode and GND through the capacitor.
22	RS	O6MA3		S/H pulse output	A pulse to sample-hold the signal. The output phase of RS is selected by serial data.
23	GND	–	–	Ground	A grounding pin.
24	VCON	ICU3	–	VD control input	An input pin to control internal vertical clock for long shutter speed. H level or open : VD L level : VD is masked by the pulse which is latched at the rising edge of VD. It's necessary to be set SMD = high and number of the fields data $n \geq 2$ in serial data control at VCON operation.
25	CKI	OSCI3	–	Clock input	An input pin for reference clock oscillation. The frequency is 35.874 MHz.
26	CKO	OSCO3	–	Clock output	An output pin for reference clock oscillation. The output is the inverse of CKI (pin 25).
27	CLK	O6MA3		Clock output	An output pin to generate HD and VD pulses. The frequency is 17.937 MHz.
28	DCLK	O6MA3		Clock output	An output pin for DSP IC. The frequency is 17.937 MHz. The output phase of DCLK is selected by serial data step by 90°.
29	VD	IC3		Vertical reference pulse input	An input pin for reference of vertical pulse. The length of low level is 9H. The period is following : Still mode : 656H Monitoring mode : 262.5H
30	VDD3	–	–	Power supply	Supply of +3.3 V power.
31	GND	–	–	Ground	A grounding pin.
32	HD	IC3		Horizontal drive pulse input	An input pin for reference of horizontal pulse. Connect to HD pin of DSP IC.
33	ED ₀	ICSU3	–	Strobe pulse input	An input pin for the strobe pulse, to control the functions of LR38616. For details, see " Serial Data Control ".
34	ED ₁	ICSU3	–	Shift register clock input	An input pin for the clock of the shift register, to control the functions of LR38616. For details, see " Serial Data Control ".

PIN NO.	SYMBOL	I/O	POLARITY	PIN NAME	DESCRIPTION
35	ED ₂	ICSU3	–	Shift register data input	An input pin for the data of the shift register, to control the functions of LR38616. For details, see " Serial Data Control ".
36	ID	O3		Line index pulse output	The pulse is used in color separator. The signal switches between high and low at every line.
37	TST ₁	ICD4	–	Test pin 1	A test pin. Set open or to L level in the normal mode.
38	TST ₂	ICD4	–	Test pin 2	A test pin. Set open or to L level in the normal mode.
39	TVMD	ICD4	–	TV mode selection input	An input pin for TV mode selection.
40	VDD4	–	–	Power supply	Supply of +4.5 V power.
41	FH ₁	O6MA43		Horizontal transfer pulse output 1	A horizontal transfer pulse for CCD. Connect to φ _{H1} pin of CCD.
42	GND	–	–	Ground	A grounding pin.
43	FH ₂	O6MA43		Horizontal transfer pulse output 2	A horizontal transfer pulse for CCD. Connect to φ _{H2} pin of CCD.
44	VDD4	–	–	Power supply	Supply of +4.5 V power.
45	TST ₃	ICD4	–	Test pin 3	A test pin. Set open or to L level in the normal mode.
46	FR	O6MA43		Reset pulse output	A pulse to reset the charge of output circuit. The output phase of FR is selected by serial data.
47	STMD	ICU4	–	Drive mode selection input	An input pin for setting the repetition to take the still picture. H level or open : 4 fields period L level : 3 fields period
48	SHTR	O3		Trigger output	A trigger pulse for effective signal period.

IC3 : Input pin (CMOS level)

ICU3 : Input pin (CMOS level with pull-up resistor)

ICSU3 : Input pin (CMOS level with schmitt-trigger)

ICU4 : Input pin (CMOS level with pull-up resistor)

ICD4 : Input pin (CMOS level with pull-down resistor)

O3 : Output pin (output high level is VDD3.)

O6MA3 : Output pin (output high level is VDD3.)

O6MA43 : Output pin (output high level is VDD4.)

OSCI3 : Input pin for oscillation

OSCO3 : Output pin for oscillation

Serial Data Control

SERIAL DATA INPUT TIMING

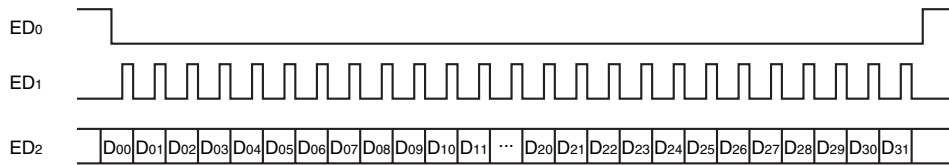

The data is shifted at the rising edge of ED1, and is latched at the rising edge of ED0.

PWSA is effective at the rising edge of ED0, but others are effective at the horizontal line in which VH1AX to VH3BX are active.

ED0 should be low level during data inputs of ED1 and ED2.

As all internal data are set to low level by ACLX or PWSA, ED0 to ED1 should be input for desirable operations.

As all internal data except PWSA are set to low level by PWSA, ED0 to ED1 should be input for desirable operations.

SERIAL DATA INPUTS

DATA	NAME	FUNCTION	DATA = L	DATA = H	AT ACLX = L
D00-D06	SD0-SD6	Step of high speed shutter	-		All L
D07	SD7	Number of exposed fields	-		All L
D08	SD8				
D09	SD9				
D10	SMD	Electronic shutter mode control	-		L
D11	INMD	Integration mode control	Monitoring	Still	L
D12	PWSA	Power save control	Normal	Power save	L
D13	PLCH	Polarity control of FCDS, FS and RS pulses	Negative	Positive	L
D14	DUMMY	Dummy	-		-
D15	BCPCNT	BCP control	Uncontinuously	Continuously	L
D16	ML1	Phase control	-		L
D17	ML2				L
D18	MR1		-		L
D19	MR2				L
D20	MR3				L
D21	MC1		-		L
D22	MC2				L
D23	MC3				L
D24	MS1		-		L
D25	MS2				L
D26	MS3				L
D27	MF1		-		L
D28	MF2				L
D29	MF3				L
D30	MA1		-		L
D31	MA2				L

ABSOLUTE MAXIMUM RATINGS

PARAMETER	SYMBOL	RATING	UNIT
Supply voltage	VDD3, VDD4	-0.3 to 6.0	V
Input voltage	VI3	-0.3 to VDD3 + 0.3	V
	VI4	-0.3 to VDD4 + 0.3	V
Output voltage	VO3	-0.3 to VDD3 + 0.3	V
	VO4	-0.3 to VDD4 + 0.3	V
Operating temperature	TOPR	-20 to +70	°C
Storage temperature	TSTG	-55 to +150	°C

ELECTRICAL CHARACTERISTICS

DC Characteristics

(VDD3 = 3.0 V to VDD4, VDD4 = 4.2 to 5.5 V, TOPR = -20 to +70 °C)

PARAMETER	SYMBOL	CONDITIONS	MIN.	TYP.	MAX.	UNIT	NOTE
Input "Low" voltage	VIL3-1				0.2VDD3	V	1, 2
Input "High" voltage	VIH3-1		0.8VDD3			V	
Input "Low" voltage	VIL3-2	Schmitt-buffer	0.2VDD3			V	3
Input "High" voltage	VIH3-2				0.75VDD3	V	
Hysteresis voltage	VT+ - VT-			0.08VDD3			
Input "Low" voltage	VIL4				0.2VDD4	V	4, 5
Input "High" voltage	VIH4		0.8VDD4			V	
Input "Low" current	IIL3-1	VI = 0 V			1.0	μA	1
Input "High" current	IIH3-1	VI = VDD3			1.0	μA	
Input "Low" current	IIL3-2	VI = 0 V	2.0		30	μA	2, 3
Input "High" current	IIH3-2	VI = VDD3			2.0	μA	
Input "Low" current	IIL4-1	VI = 0 V	4.0		60	μA	4
Input "High" current	IIH4-1	VI = VDD4			2.0	μA	
Input "Low" current	IIL4-2	VI = 0 V			2.0	μA	5
Input "High" current	IIH4-2	VI = VDD4	4.0		60	μA	
Output "Low" voltage	VOL3-1	IOL = 2 mA			0.4	V	6
Output "High" voltage	VOH3-1	IOH = -1 mA	VDD3 - 0.5			V	
Output "Low" voltage	VOL3-2	IOL = 3 mA			0.4	V	7
Output "High" voltage	VOH3-2	IOH = -3 mA	VDD3 - 0.5			V	
Output "Low" voltage	VOL4	IOL = 10 mA			0.4	V	8
Output "High" voltage	VOH4	IOH = -10 mA	VDD4 - 0.5			V	

NOTES :

1. Applied to inputs (IC3, OSCI3).
2. Applied to input (ICU3).
3. Applied to input (ICSU3).
4. Applied to input (ICU4).
5. Applied to input (ICD4).
6. Applied to output (O3).
7. Applied to outputs (OSCO3, O6MA3). (Output (OSCO3) measures on condition that input (OSCI3) level is 0 V or VDD3.)
8. Applied to output (O6MA43).

PACKAGE

(Unit : mm)

48 QFP (QFP048-P-0707)

