



LC65P29

One-Time Programmable 4-Bit Single-Chip Microcontroller

Overview

The LC65P29 is a one-time programmable (on-chip PROM) version of Sanyo's LC6529N/F/L 4-bit single-chip CMOS microcontroller. It provides identical functionality to, and pin compatibility with, the mask ROM versions of the LC6529N/F/L, and provides a 1-KB internal PROM. The LC65P29 is provided in DIP24S and MFP30S plastic packages and the program can be written by the customer, thus makes this IC appropriate for the limited-run products and the startup of initial production of new products. Furthermore, it can provide reduced changeover periods when end product specifications change.

Additionally, the LC65P29 can function as a one-time programmable PROM version of the Sanyo LC6527N/F/L and LC6528N/F/L by using the 29T27 adapter socket.

Features

- Mask option settings can be switched by setting PROM data.
- All options, except for the port output circuit type can be set with PROM data.
- 1-KB PROM
- PROM data security function
- Pin compatible with the mask ROM version
- Instruction cycle time: 0.92 μ s to 20 μ s
- Packages: DIP24S and MFP30S

Package Dimensions

unit: mm

3067-DIP24S(300mil)

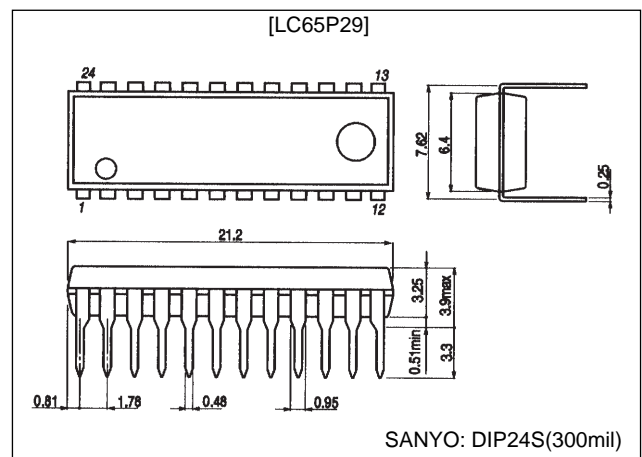

unit: mm

3216-MFP30S(375mil)

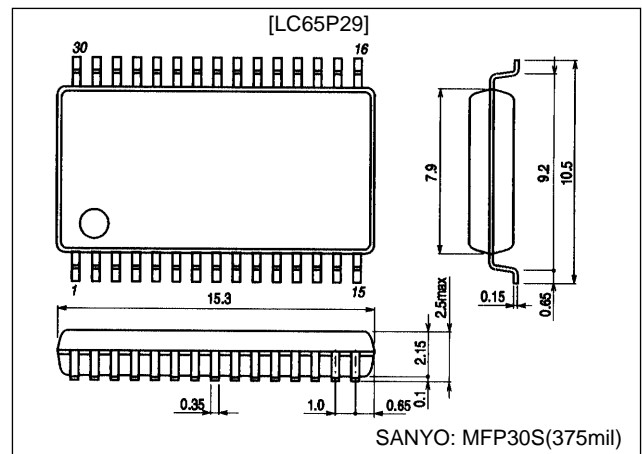

Note: The package dimension figures are provide for reference purposes without dimensional tolerances. Contact your Sanyo representative for the official package dimension figures.

LC65P29

Notes on Sanyo ROM Writing Services

Sanyo provides a for-fee ROM writing service that consists of writing the one-time programmable ROM , printing, screening, and readout verification. Contact your Sanyo representative for details.

Pin Assignments

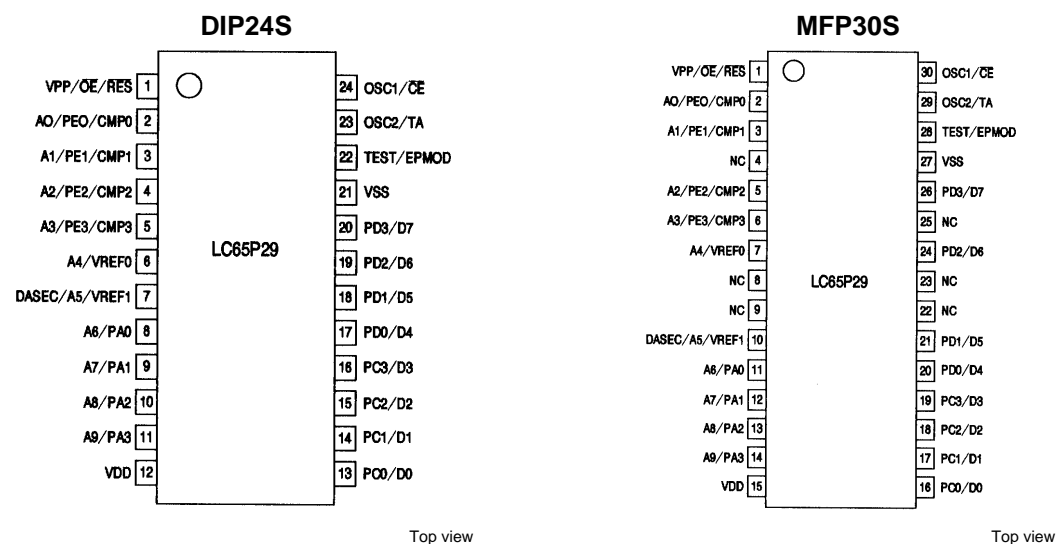

Product Series Structure

Type number.	Number of pins	ROM capacity	RAM capacity	Package
LC6527N/F/L, LC6528N/F/L	18	1K, 0.5K	64W, 32W	DIP18, MFP18
LC6529N/F/L	24/30	1K	64W	DIP24S, SSOP24, MFP30S
LC65E29	24/30	1K	64W	DIP24S, MFP30S
LC65P29	24/30	1K	64W	DIP24S, MFP30S
LC6543N/F/L, LC6546N/F/L	30	2K, 1K	128W, 64W	DIP30S, MFP30S
LC65E43	30	2K	128W, 64W	DIP30S, MFP30S
LC65P43	30	2K	128W, 64W	DIP30S, MFP30S
LC651104N/F/L, LC651102N/F/L	30	4K, 2K	256W	DIP30S, MFP30S
LC651204N/F/L, LC651202N/F/L	30	4K, 2K	256W	DIP30S, MFP30S
LC65E1104	30	4K	256W	DIP30S, MFP30S
LC65P1104	30	4K	256W	DIP30S, MFP30S

LC65P29

Usage Notes

The LC65P29 is designed for program development and evaluation for systems that use the LC6529N/F/L. The following points require attention when using this product.

- Mounting notes

Due to the nature of the device, one-time programmable microcontrollers cannot be fully tested prior to shipment. This means that users must perform the screening process described on page 14.

- ROM ordering procedure when using the Sanyo for-fee ROM writing service

The customer must abide by the following when using the Sanyo for-fee ROM writing service:

- When ordering both one-time programmable and mask versions at the same time

The customer must provide an EPROM for the mask version, the mask version order forms, and the one-time programmable version order forms.

- When order only the one-time programmable version

The customer must provide an EPROM for the one-time programmable version and the one-time programmable version order forms. The end area in the EPROM (locations 400 to 404H) is the option specification area and the customer must program the option specification data in that area. The customer must use the cross assembler specified by Sanyo.

- Differences between the LC65P29 and the LC6529N/F/L

Parameter		LC65P29	LC6529N	LC6529F	LC6529L
Option	Ports C and D output option during reset	High or low can be specified (option code)	High or low can be specified (mask option)		
	Port output type during reset	Open-drain output only (ports A, C, and D)	Open-drain or pull-up register can be specified (mask option)		
	Oscillator circuit option	CF/RC or EXT can be specified (option code)	CF/RC or EXT can be specified (mask option)	CF or EXT can be specified (mask option)	CF/RC or EXT can be specified (mask option)
	Divider circuit option	1/1, 1/3, or 1/4 can be specified (option code)	1/1, 1/3 or 1/4 can be specified (mask option)	Only 1/1 is possible (mask option)	1/1, 1/3 or 1/4 can be specified (mask option)
	Comparator input and port E input option	Comparator or port E can be specified (option code)	Comparator or port E can be specified (mask option)		
	Comparator function option	Feedback resistor present or absent can be specified (option code)	Feedback resistor present or absent can be specified (mask option)		
Characteristic	Minimum cycle time	0.92 μs ($V_{\text{DD}} \geq 3.0 \text{ V}$)	2.77 μs ($V_{\text{DD}} \geq 3.0 \text{ V}$)	0.92 μs ($V_{\text{DD}} \geq 3.0 \text{ V}$)	3.84 μs ($V_{\text{DD}} \geq 2.2 \text{ V}$)
	Operating temperature	-30 to +70°C	-40 to +85°C		
	Supply voltage	3.0 to 6.0 V	3.0 to 6.0 V	3.0 to 6.0 V	2.2 to 6.0 V
	Current drain	5.0 mA typ.	2.0 mA typ.	2.5 mA typ.	2.0 mA typ.
	Reset port input low-level current	-50 μA typ.	-10 μA typ.		
Other items	Package	DIP24S, MFP30S	DIP24S, SSOP24, MFP30S		

System Block Diagram

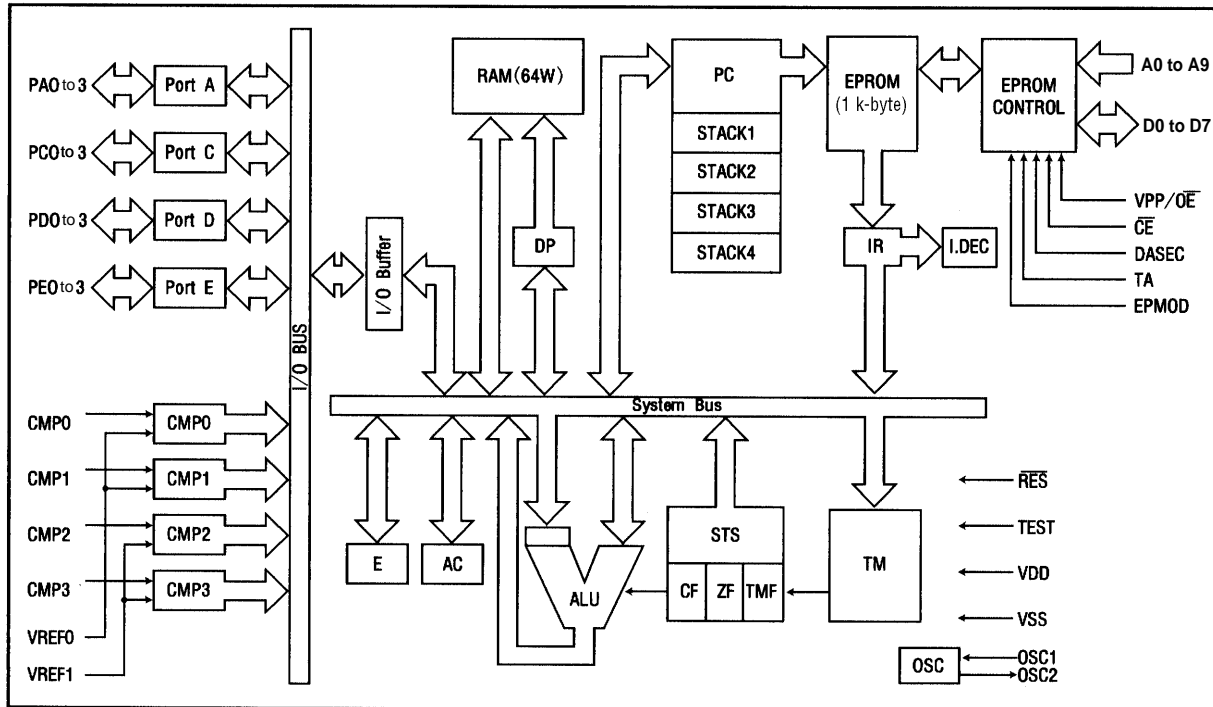

- | | |
|--------------------------------|----------------------------|
| RAM: Data memory | EPROM: Program memory |
| ALU: Arithmetic and logic unit | PC: Program counter |
| DP: Data pointer | I.R.: Instruction register |
| E: E register | I.DEC: Instruction decoder |
| AC: Accumulator | CF: Carry flag |
| OSC: Oscillator circuit | ZF: Zero flag |
| TM: Timer | TMF: Timer overflow flag |
| STS: Status register | |

LC65P29

Pin Descriptions

Pin name	Number of pins	I/O	Function	Option	State during reset	Function in PROM mode
V _{DD} V _{SS}	1 1	— —	Power supply. Must be connected to +5 V during normal operation. Power supply. Must be connected to 0 V during normal operation.		— —	
OSC1/ $\overline{\text{CE}}$ OSC2/TA	1	I O	System clock oscillator connections. Leave OSC2 open and input the external clock to OSC1 if an external clock is used.	1. Two-pin RC oscillator (Single-pin external clock input) 2. Two-pin ceramic oscillator 3. Divisor option: 1/1, 1/3, or 1/4		EPROM control signal inputs CE TA
PA0/A6 PA1/A7 PA2/A8 PA3/A9	4	I/O	<ul style="list-style-type: none"> I/O ports A0 to A3 Input in 4-bit units (IP instruction) Output in 4-bit units (OP instruction) Data testing in 1-bit units (BP and BNP instructions) Data set and clear operations in 1-bit units (SPB and RPB instructions) PA3 is used for standby mode control. Applications must assure that chattering (key bounce) noise is not input during a HALT instruction execution cycle. 	Open-drain output	<ul style="list-style-type: none"> High-level output (The n-channel output transistor turned off.) 	<ul style="list-style-type: none"> Address inputs A6 to A9
PC0/D0 PC1/D1 PC2/D2 PC3/D3	4	I/O	<ul style="list-style-type: none"> I/O ports C0 to C3 The pin functions are identical to those of pins A0 to A3. However, there is no standby mode control function. The output during a reset can be specified to be either high or low as an option. 	<ol style="list-style-type: none"> Open-drain output High-level output during reset Low-level output during reset <ul style="list-style-type: none"> Selection of items 2 or 3 is in 4-bit units. 	<ul style="list-style-type: none"> High-level output Low-level output (Depending on an option selection.) 	<ul style="list-style-type: none"> Data I/O D0 to D3
PD0/D4 PD1/D5 PD2/D6 PD3/D7	4	I/O	<ul style="list-style-type: none"> I/O ports D0 to D3 The pin functions are identical to those of pins PC0 to PC3. 	The same as for pins PC0 to PC3	The same as pins PC0 to PC3	<ul style="list-style-type: none"> Data I/O D4 to D7
PE0/CMP0/A0 PE1/CMP1/A1 PE2/CMP2/A2 PE3/CMP3/A3	4 4	I I	<ul style="list-style-type: none"> When comparator input is selected: CMP0 and CMP1 use V_{REF0} as the reference voltage, CMP2 and CMP3 use V_{REF1} as the reference voltage, Comparator inputs CMP0 to CMP3 Data input in 4-bit units (IP instruction) Data testing in 1-bit units (BP and BNP instructions) 	<ol style="list-style-type: none"> Comparator input Port E input No feedback resistor Feedback resistor present <ul style="list-style-type: none"> Selection of items 1 or 2 is in 4-bit units. Items 3 and 4 are only specified when item 1 is selected. 		<ul style="list-style-type: none"> Address inputs A0 to A3
V _{REF0} /A4 V _{REF1} /A5/ DASEC	2	I	<ul style="list-style-type: none"> Comparator reference voltage inputs V_{REF0} and V_{REF1} V_{REF0} is the reference voltage input for CMP0 and CMP1. V_{REF1} is the reference voltage input for CMP2 and CMP3. When PE0/CMP0 to PE3/CMP3 are selected to function as port E inputs, these pins are connected to V_{SS}. 			<ul style="list-style-type: none"> Address inputs A4 and A5 EPROM control signal input DASEC
$\overline{\text{RES}}$ /V _{pp} / $\overline{\text{OE}}$	1	I	<ul style="list-style-type: none"> System reset input Connect an external capacitor to effect the power-on reset. Input a low level for at least 4 clock cycles to effect a reset restart. 			<ul style="list-style-type: none"> EPROM control signal input V_{pp}/OE
TEST/EPMOD	1	I	<ul style="list-style-type: none"> IC test pin This pin must be connected to V_{SS} during normal operation. 			<ul style="list-style-type: none"> EPROM control signal input EPMOD

User Options

- Ports C and D output level during reset option

One of the following two options for the output level during a reset can be selected for each of the ports C and D in 4-bit units.

Option	Conditions and notes
High-level output at reset	Ports C and D in 4-bit units
Low-level output at reset	Ports C and D in 4-bit units

- Port output circuit type option

The I/O ports A, C, and D are always set up as open-drain outputs.

Option	Circuit
Open-drain output (OD)	

- Oscillator circuit options

Option	Circuit	Conditions and notes
External clock		The OSC2 pin must be left open.
Two-pin RC oscillator		
Two-pin ceramic oscillator		

- Divisor option

Option	Circuit	Conditions and notes
No divisor (1/1)		Can be used with any of the 3 oscillator options. (N, F, and L versions)
Divide-by-3 circuit (1/3)		Can only be used with the external clock and ceramic oscillator options. (N and L versions)
Divide-by-4 circuit (1/4)		Can only be used with the external clock and ceramic oscillator options. (N and L versions)

• Comparator input/port E input option

Whether the 4 port pins PE0/CMP0, PE1/CMP1, PE2/CMP2, and PE3/CMP3 function as comparator inputs or as port E inputs can be selected.

Option	Conditions and notes
Comparator inputs	All 4 bits specified together
Port E inputs	All 4 bits specified together

• Comparator function option

One of two options relating to the comparator function can be selected.

Option	Circuit	Conditions and notes
No feedback resistor		The comparator can be used without hysteresis.
Feedback resistor present		When used with an added external resistor, the comparator can be used with hysteresis.

Usage Procedures

• Option specification procedures

User options can be selected interactively by running the LC6529 option entry software (SU60K). This creates an option file (file.opt).

Assembling the user program with the macro assembler (M60K) creates an object file. An evaluation file (file.eva) can be created by linking the object file and the option file with the linker (L60K). Then, a HEX format object file, which includes both the user program and the mask options, can be created by converting the evaluation file with the file conversion software (E2H60K). This creates the option codes in the option specification area (locations 400 to 404H).

It is also possible to store data directly to the option specification area. Refer to the option code creation table on page 9 to do this.

Refer to the “LC65/66K Software Manual” for details.

• EPROM programming procedure

A general-purpose EPROM programmer can be used to write the created data to the LC65P29 by using a special-purpose write conversion board (either the W65EP29D or the W65EP29M).

— The EPROM programmers listed below can be used.

Manufacturer	Models that can be used
ADVANTEST	R4945, R4944A, R4943 or equivalent
ANDO	—
AVAL	—
MINATO Electronics	—

— The “27512 (VPP: 12.5 V) Intel fast write” method must be used for writing. Specify locations 0 to 404 as the address settings, and make sure that the DASEC jumper is in the off position.

• Using the data security function

The data security function is a function that prevents data written previously to the microcontroller EPROM from being read out. Use the following procedure to apply the data security to the LC65P29.

1. Set the DASEC jumper on the write conversion board to the on position.
2. Write the data once again.

At this point, the EPROM writer will indicate an error since this function has operated, but actually, no error has occurred in either the programmer or the IC.

Notes: • The data security function will not be applied if the data value FF is written to all address in step 2.

- The data security function will not be applied if the sequence BLANK → PROGRAM → VERIFY is performed at step 2.
- Always return the jumper to the off position after performing this procedure.

LC65P29

LC65P29 (DIP24S)

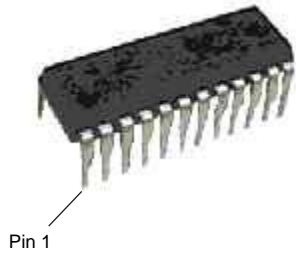

LC65P29 (MFP30S)

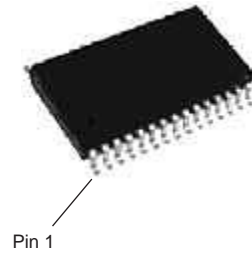

Insert the LC65P29 into the socket correctly

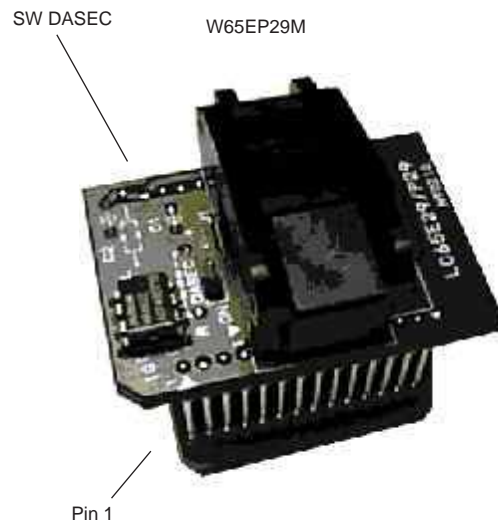
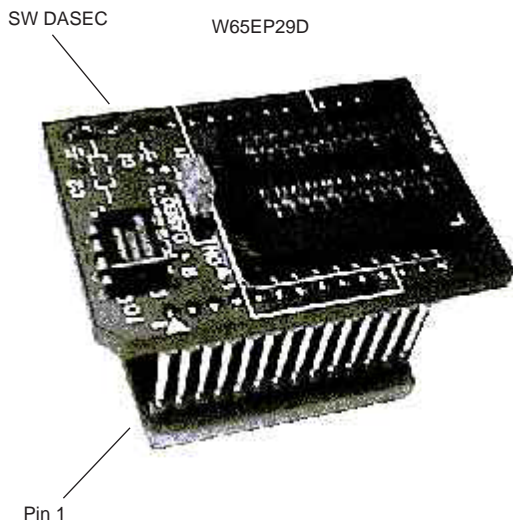

DASEC setting

- For normal writing

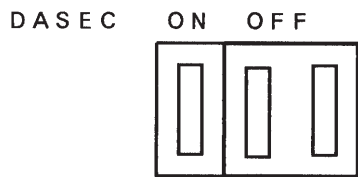

- For writing with the security function applied

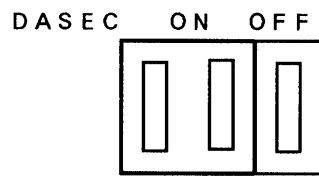

• Option data area and definition

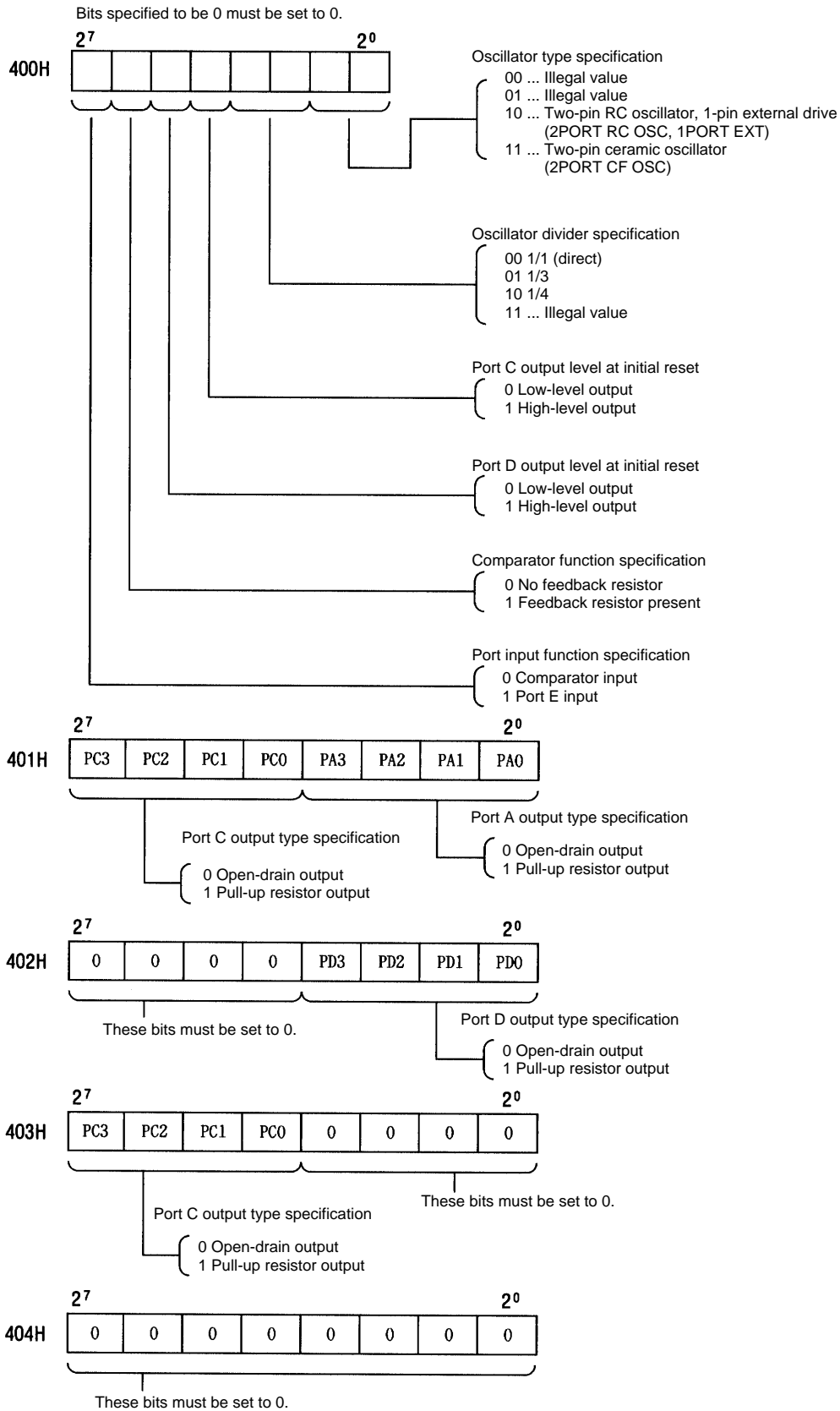

Note: Although all ports are set up to be open-drain outputs regardless of the port option data in the LC65P29, be sure to specify the port option data if you are using the LC6529N/F/L (mask ROM version).

LC65P29

Absolute Maximum Ratings at $T_a = 25^\circ\text{C}$, $V_{SS} = 0\text{ V}$

Parameter	Symbol	Applicable pins/notes	Conditions	Ratings			Unit
				min	typ	max	
Maximum supply voltage	$V_{DD\ max}$	V_{DD}		-0.3		+7.0	V
Output voltage	V_O	OSC2		Values up to the generated voltage are allowed.			V
Input voltage	V_{I1}	OSC1*1		-0.3		$V_{DD} + 0.3$	V
	V_{I2}	TEST, \overline{RES}		-0.3		$V_{DD} + 0.3$	V
	V_{I3}	Ports with PE specifications		-0.3		$V_{DD} + 0.3$	V
I/O voltage	V_{IO}	PA, PC, PD		-0.3		+15	mA
Peak output current	I_{OP}	PA, PC, PD		-2		+20	mA
Average output current	I_{OA}	PA, PC, PD	The 100 ms average per pin	-2		+20	mA
	ΣI_{OA1}	PA	The total current for pins PA0 to PA3*2	-6		+40	mA
	ΣI_{OA2}	PC, PD	The total current for pins PC0 to PC3 and PD0 to PD3*3	-14		+90	mA
Allowable power dissipation	P_{dmax1}		$T_a = -30\text{ to }+70^\circ\text{C(DIP24S)}$			360	mW
	P_{dmax2}		$T_a = -30\text{ to }+70^\circ\text{C(MFP30S)}$			150	mW
Operating temperature	T_{opr}			-30		+70	$^\circ\text{C}$
Storage temperature	T_{stg}			-55		+125	$^\circ\text{C}$

Notes: 1. Values up to the generated oscillator amplitude are allowed when driven internally using the guaranteed circuit constant values with the oscillator circuit shown in figure 2.
2. The average over a 100 ms period.

Allowable Operating Conditions at $T_a = -30\text{ to }+70^\circ\text{C}$, $V_{SS} = 0\text{ V}$, $V_{DD} = 3.0\text{ to }6.0\text{ V}$

Parameter	Symbol	Applicable pins/notes	Conditions	V_{DD} [V]	Ratings			Unit
					min	typ	max	
Operating supply voltage	V_{DD}	V_{DD}			3.0		6.0	V
Standby supply voltage	V_{ST}	V_{DD}	RAM and register retention *		1.8		6.0	V
High-level input voltage	V_{IH1}	PA, PC, PD	Output n-channel transistor off		$0.7 V_{DD}$		$13.5 V_{DD}$	V
	V_{IH2}	PE	When the port E input option is selected		$0.7 V_{DD}$		V_{DD}	V
	V_{IH3}	\overline{RES}		1.8 to 6.0	$0.8 V_{DD}$		V_{DD}	V
	V_{IH4}	OSC1	When the RC oscillator and external clock option is selected		$0.8 V_{DD}$		V_{DD}	V
Low-level input voltage	V_{IL1}	PA, PC, PD	Output n-channel transistor off		V_{SS}		$0.3 V_{DD}$	V
	V_{IL2}	PE	When the port E input option is selected		V_{SS}		$0.3 V_{DD}$	V
	V_{IL3}	OSC1	When the RC oscillator and external clock option is selected		V_{SS}		$0.25 V_{DD}$	V
	V_{IL4}	TEST			V_{SS}		$0.3 V_{DD}$	V
	V_{IL5}	\overline{RES}			V_{SS}		$0.25 V_{DD}$	V
Operating frequency (cycle time)	$f_{op}(t_{CYC})$				200 (20)		4330 (0.92)	kHz (μs)
External clock conditions	Frequency	$f_{ext}(\text{text})$	OSC1	See Figure 1		200 (20)	4330 (0.92)	kHz (μs)
	Pulse width	$\text{textH}, \text{textL}$	OSC1	See Figure 1		69		ns
	Rise and fall times	$\text{textR}, \text{textF}$	OSC1	See Figure 1			50	ns
Guaranteed oscillator circuit constants	Two-pin RC oscillator	C_{ext}	OSC1, OSC2	See Figure 2	4 to 6	$220 \pm 5\%$		pF
		C_{ext}	OSC1, OSC2	See Figure 2		$220 \pm 5\%$		pF
		R_{ext}	OSC1, OSC2	See Figure 2	4 to 6	$6.8 \pm 1\%$		k Ω
		R_{ext}	OSC1, OSC2	See Figure 2		$15.0 \pm 1\%$		k Ω
Ceramic oscillator			See Figure 2		See Table 1			

Note *: Applications must maintain the operating supply voltage (V_{DD}) until the IC has entered the standby state when a HALT instruction is executed. Also, applications must assure that chattering (key bounce) noise is not input to the PA3 pin during a HALT instruction execution cycle.

LC65P29

Electrical Characteristics at Ta = -30 to +70°C, VSS = 0 V, VDD = 3.0 to 6.0 V

Parameter	Symbol	Applicable pins/notes	Conditions	Ratings			Unit			
				VDD [V]	min	typ		max		
High-level input current	I _{IH1}	PA, PC, PD	Output n-channel transistor off (Includes the n-channel transistor off leakage current) V _{IN} = 13.5 V				5.0	μA		
	I _{IH2}	PE	When the port E input option is selected V _{IN} = V _{DD}				5.0	μA		
	I _{IH3}	OSC1	When the RC oscillator and external clock option is selected V _{IN} = V _{DD}				1.0	μA		
Low-level input current	I _{IL1}	PA, PC, PD	Output n-channel transistor off (Includes the n-channel transistor off leakage current) V _{IN} = V _{SS}		-1.0			μA		
	I _{IL2}	PE	When the port E input option is selected V _{IN} = V _{SS}		-1.0			μA		
	I _{IL3}	RES	V _{IN} = V _{SS}		-80	-50		μA		
	I _{IL4}	OSC1	When the RC oscillator and external clock option is selected V _{IN} = V _{SS}		-1.0			μA		
Low-level output voltage	V _{OL1}	PA, PC, PD	I _{OL} = 10 mA				1.5	V		
	V _{OL2}	PA, PC, PD	I _{OL} = 1.8 mA (When all port I/O levels are Under 1 mA)				0.4	V		
Hysteresis voltage	V _{HIS1}	RES				0.1 V _{DD}		V		
	V _{HIS2}	OSC1*1	When the RC oscillator and external clock option is selected			0.1 V _{DD}		V		
Current drain	RC oscillator	IDOP1	V _{DD}	Figure 2. 850 kHz (TYP)		5	8	mA		
		IDOP2	V _{DD}	Figure 2. 400 kHz (TYP)		4.5	7	mA		
	Ceramic oscillator*2	IDOP3	V _{DD}	Figure 3. 4 MHz, 1/1, 1/3, and 1/4 divisor ratios		5	8	mA		
		IDOP4	V _{DD}	Figure 3. 2 MHz, 1/1, 1/3, and 1/4 divisor ratios		4.5	7	mA		
		IDOP5	V _{DD}	Figure 3. 800 kHz, 1/1 divisor ratio		5	8	mA		
		IDOP6	V _{DD}	Figure 3. 400 kHz, 1/1 divisor ratio		4.5	7	mA		
	External clock*2	IDOP7	V _{DD}	200 to 4330 kHz, 1/1, 1/3, and 1/4 divisor ratios		5	8	mA		
	Standby mode	IDDSt1	V _{DD}	Output n-channel transistor off Port = V _{DD}	6		0.05	10	μA	
IDDSt2		V _{DD}	Output n-channel transistor off Port = V _{DD}	3		0.025	5	μA		
Oscillator characteristics	RC oscillator	Oscillator frequency	fMOSC	OSC1, OSC2	Figure 2. Cext = 220 pF ±5% Rext = 15.0 kΩ ±1%		275	400	711	kHz
			OSC1, OSC2	Figure 2. Cext = 220 pF ±5% Rext = 6.8 kΩ ±1%	4 to 6	579	850	1179	kHz	
	Ceramic oscillator	Oscillator frequency	fFOSC*3	OSC1, OSC2	Figure 3. fo = 4 MHz		3840	4000	4160	kHz
			OSC1, OSC2	Figure 3. fo = 2 MHz		1920	2000	2080	kHz	
			OSC1, OSC2	Figure 3. fo = 800 kHz		768	800	832	kHz	
			OSC1, OSC2	Figure 3. fo = 400 kHz		384	400	416	kHz	
Oscillator stabilization time	tCFS			Figure 4. fo = 4 MHz				10	ms	
				Figure 4. fo = 2 MHz fo = 800 kHz fo = 400 kHz				10	ms	
Pull-up resistor reset port	Ru		V _{IN} = V _{SS}	5	70	100	150	kΩ		
External reset characteristics: reset time	tRST					See Figure 6.		ms		
Pin capacitance	Cp		f = 1 MHz V _{IN} = V _{SS} for all input pins other than the measured pin			10		pF		

Notes: 1. The OSC1 pin has Schmitt characteristics when the RC oscillator and external clock input oscillator option is selected.

2. The current drain during normal operation with the output n-channel transistors off and the port at V_{DD}.

3. tCFOSC indicates frequencies at which oscillator operation is possible.

LC65P29

Comparator characteristics (When the comparator input option is selected)

at $T_a = -30$ to $+70^\circ\text{C}$, $V_{SS} = 0\text{ V}$, $V_{DD} = 3.0$ to 6.0 V

Parameter	Symbol	Applicable pins/notes	Conditions	Ratings			Unit	
				V_{DD} [V]	min	typ		max
Reference input voltage range	$V_{RF_{IN}}$	$V_{REF0}, 1$			$V_{SS} + 0.3$		$V_{DD} - 1.7$	V
Common-mode input voltage range	$V_{CM_{IN}}$	CMP0 to 3			V_{SS}		$V_{DD} - 1.7$	V
Offset voltage	V_{OFF}		$V_{CMIN} = V_{SS}$ to $V_{DD} - 1.7\text{ V}$			± 50	± 300	mV
Response speed	TRS1		See Figure 5.	4 to 6		1.0	5.0	μs
	TRS2		See Figure 5.			1.0	200	μs
High-level input current	I_{IH1}	$V_{REF0}, 1$					1.0	μA
	I_{IH2}	CMP0 to 3	When the feedback resistor option is not selected				5.0	μA
Low-level input current	I_{IL1}	$V_{REF0}, 1$				-1.0		μA
	I_{IL2}	CMP0 to 3	When the feedback resistor option is not selected			-1.0		μA
Feedback resistance	RCMFB	CMP0 to 3	When the feedback resistor option is selected			460		$\text{k}\Omega$

Table 1 Guaranteed Ceramic Oscillator Circuit Constants

Standard type						Chip type				
Oscillator type	Manufacturer	Oscillator element	C1	C2	R_d	Manufacturer	Oscillator element	C1	C2	
External capacitor type	4 MHz	Murata Mfg. Co., Ltd.	CSA4.00MG	33 pF $\pm 10\%$	33 pF $\pm 10\%$	—	Murata Mfg. Co., Ltd.	CSAC4.00MGC	33 pF $\pm 10\%$	33 pF $\pm 10\%$
		Kyocera Corporation	KBR-4.0MSA	33 pF $\pm 10\%$	33 pF $\pm 10\%$	—	—	—	—	—
	2 MHz	Murata Mfg. Co., Ltd.	CSA2.00MG	33 pF $\pm 10\%$	33 pF $\pm 10\%$	—	Murata Mfg. Co., Ltd.	CSAC2.00MGC	33 pF $\pm 10\%$	33 pF $\pm 10\%$
		Kyocera Corporation	KBR-2.0MS	47 pF $\pm 10\%$	47 pF $\pm 10\%$	—	—	—	—	—
External capacitor type	800 kHz	Murata Mfg. Co., Ltd.	CSB800J	100 pF $\pm 10\%$	100 pF $\pm 10\%$	3.3 $\text{k}\Omega$	—	—	—	—
		Kyocera Corporation	KBR-800F/Y	150 pF $\pm 10\%$	150 pF $\pm 10\%$	—	—	—	—	—
	400 kHz	Murata Mfg. Co., Ltd.	CSB400P	220 pF $\pm 10\%$	220 pF $\pm 10\%$	3.3 $\text{k}\Omega$	—	—	—	—
		Kyocera Corporation	KBR-400BK/Y	330 pF $\pm 10\%$	330 pF $\pm 10\%$	—	—	—	—	—
Internal capacitor type	4 MHz	Murata Mfg. Co., Ltd.	CST4.00MGW	—	—	—	—	—	—	
		Kyocera Corporation	KBR-4.0MKS	—	—	—	Kyocera Corporation	KBR-4.0MWS	—	—
	2 MHz	Murata Mfg. Co., Ltd.	CST2.00MG	—	—	—	—	—	—	
	—	—	—	—	—	Kyocera Corporation	KBR-2.0MWS	—	—	

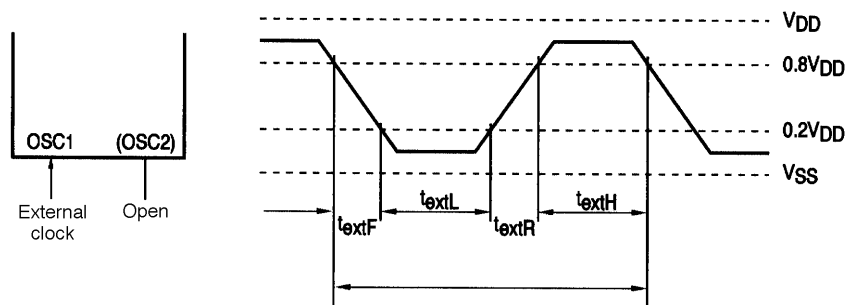

Figure 1 External Clock Input Waveform

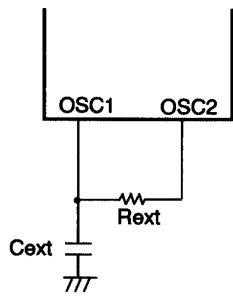

Figure 2 Two-Pin RC Oscillator Circuit

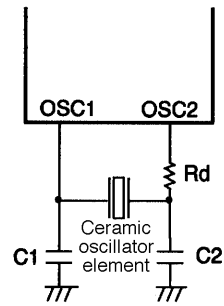

Figure 3 Ceramic Oscillator Circuit

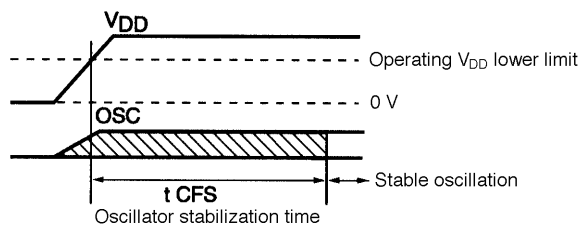

Figure 4 Oscillator Stabilization Time

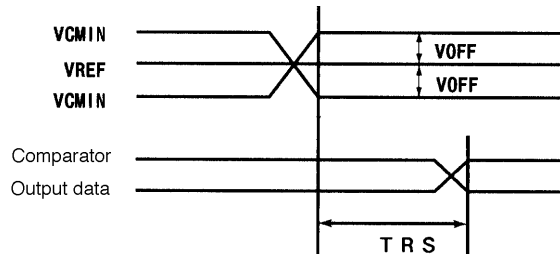

Figure 5 Comparator Response Speed TRS Timing

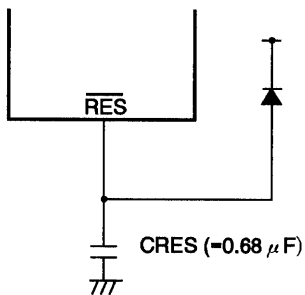

Figure 6 Reset Circuit

Note: The reset period due to a CRES with a value of 0.68 μF will be 10 to 100 ms when the power supply rise time is zero.
If the power supply rise time is relatively long, increase the value of CRES so that the reset time is at least 10 ms, which is the oscillator stabilization time.

Notes on Mounting Preconditions for One-Time Programmable Microcontrollers

This product is provided in both DIP and MFP packages. Since the mounting preconditions are different for these two package types, implement the flowchart appropriate for the product used.



See the following item for details on the screening conditions.

Notes on One-Time Programmable Microcontroller Screening

Due to the structure of their circuits, it is not possible for Sanyo to fully test one-time programmable microcontroller products before the PROM has been written. To increase the reliability after the PROM has been written, we strongly recommend screening these products after writing according to the following flowchart.

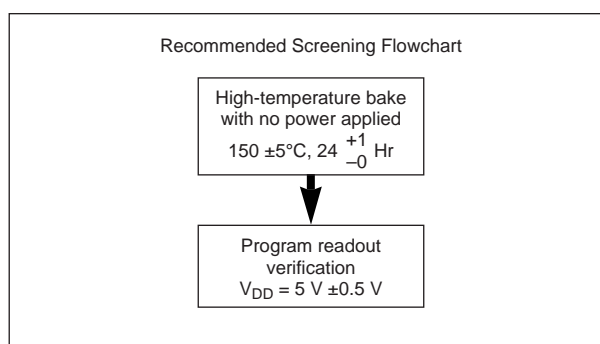

Due to the structure of the one-time programmable microcontroller PROM circuit in the state before writing, it is not possible to write test all the bits in the device. This means that it is impossible to guarantee a yield of 100%.

- No products described or contained herein are intended for use in surgical implants, life-support systems, aerospace equipment, nuclear power control systems, vehicles, disaster/crime-prevention equipment and the like, the failure of which may directly or indirectly cause injury, death or property loss.
- Anyone purchasing any products described or contained herein for an above-mentioned use shall:
 - ① Accept full responsibility and indemnify and defend SANYO ELECTRIC CO., LTD., its affiliates, subsidiaries and distributors and all their officers and employees, jointly and severally, against any and all claims and litigation and all damages, cost and expenses associated with such use:
 - ② Not impose any responsibility for any fault or negligence which may be cited in any such claim or litigation on SANYO ELECTRIC CO., LTD., its affiliates, subsidiaries and distributors or any of their officers and employees jointly or severally.
- Information (including circuit diagrams and circuit parameters) herein is for example only; it is not guaranteed for volume production. SANYO believes information herein is accurate and reliable, but no guarantees are made or implied regarding its use or any infringements of intellectual property rights or other rights of third parties.

This catalog provides information as of June, 1998. Specifications and information herein are subject to change without notice.