

Infrared light emitting diode, top view type

SIR-563ST3F

The SIR-563ST3F is a GaAs infrared light emitting diode housed in clear plastic. This device has a high luminous efficiency and a 940 nm peak wavelength suitable for silicon detectors. It has a wide radiation angle and is ideal for compact optical control equipment.

●Applications

Optical control equipment

Light source for remote control devices

●Features

- 1) High efficiency, high output $P_O = 11.0$ mW ($I_F = 50$ mA).
- 2) Wide radiation angle $\theta_{1/2} = 15$ deg.
- 3) Emission spectrum well suited to silicon detectors ($\lambda_P = 940$ nm).
- 4) Good current-optical output linearity.
- 5) Long life, high reliability.
- 6) Low cost, clear epoxy resin package.

●External dimensions (Units: mm)

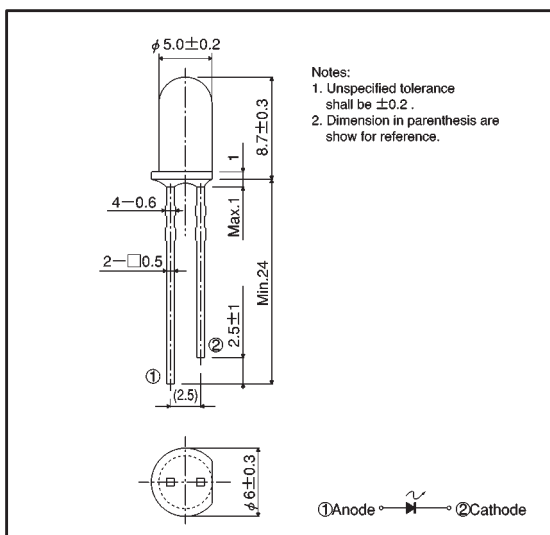

●Absolute maximum ratings ($T_a = 25^\circ\text{C}$)

Parameter	Symbol	Limits	Unit
Forward current	I_F	100	mA
Reverse voltage	V_R	5	V
Power dissipation	P_D	160	mW
Pulse forward current	I_{FP}^*	1.0	A
Operating temperature	T_{opr}	$-25 \sim +85$	$^\circ\text{C}$
Storage temperature	T_{stg}	$-40 \sim +85$	$^\circ\text{C}$

* Pulse width = 0.1 msec, duty ratio 1%

●Electrical and optical characteristics (Ta = 25°C)

Parameter	Symbol	Min.	Typ.	Max.	Unit	Conditions
Optical output	P _O	—	11	—	mW	I _F =50mA
Emitting strength	I _E	9.0	21	—	mW/sr	I _F =50mA
Forward voltage	V _F	—	1.34	1.6	V	I _F =50mA
Reverse current	I _R	—	—	10	μA	V _R =3V
Peak light emitting wavelength	λ _P	—	940	—	nm	I _F =50mA
Spectral line half width	Δλ	—	40	—	nm	I _F =50mA
Half-viewing angle	θ _{1/2}	—	±15	—	deg	I _F =50mA
Response time	t _r · t _f	—	1.0	—	μs	I _F =50mA
Cut-off frequency	f _c	—	1.0	—	MHz	I _F =50mA

●Electrical and optical characteristic curves

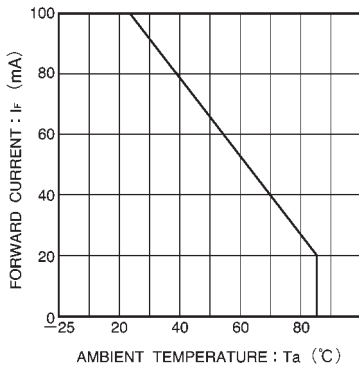

Fig. 1 Forward current

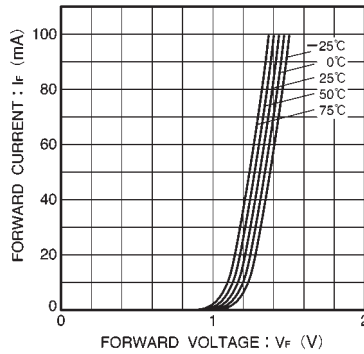

Fig.2 Forward current vs. forward voltage

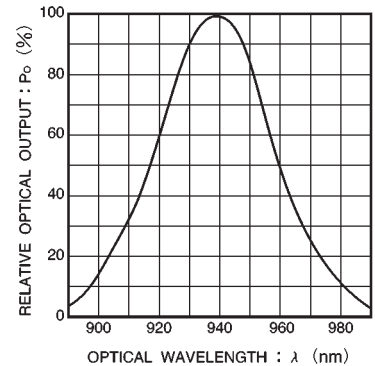

Fig.3 Wavelength

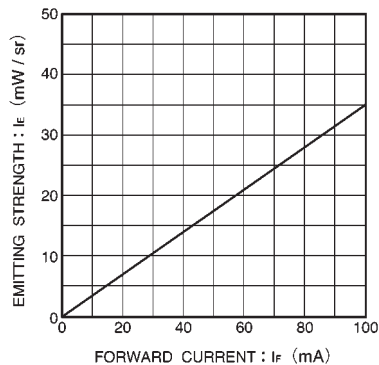

Fig. 4 Emitting strength vs. forward current

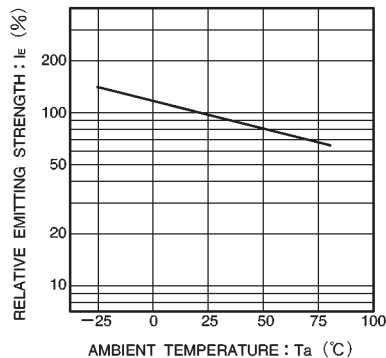

Fig.5 Relative emitting strength vs. ambient temperature

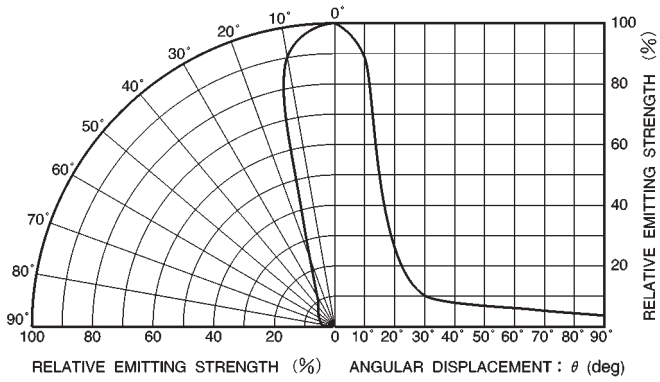

Fig. 6 Directional pattern