

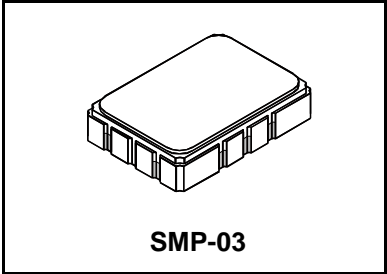

**SF1146B**

**499.25 MHz  
SAW Filter**



- **Low Insertion Loss**
- **5.0 X 7.0 mm Surface-Mount Case**
- **Complies with Directive 2002/95/EC (RoHS)**

**Absolute Maximum Ratings**

Rating	Value	Units
Maximum Incident Power in Passband	+10	dBm
Max. DC voltage between any 2 terminals	30	VDC
Storage Temperature Range	-40 to +85	°C
Suitable for lead-free soldering - Max Soldering Profile	260°C for 30 s	

**Electrical Characteristics**

Characteristic	Sym	Notes	Min	Typ	Max	Units	
Nominal Center Frequency	$f_c$	1	499.25			MHz	
Passband	Insertion Loss at $f_c$	1, 2			3.5	dB	
	1.5 dB Passband		$BW_1$	$\pm 15$			kHz
	4.0 dB Passband			30			MHz
	Group Delay Variation over $f_c \pm 250$ kHz	GDV		177	250	ns <sub>p-p</sub>	
Rejection	$f_c \pm 1.5$ MHz	1, 2, 3	5			dB	
	$f_c \pm 6.0$ MHz		20				
	$f_c \pm 50$ MHz		50				
Operating Temperature Range	$T_A$	1	-40		+85	°C	
Differential Input and Output Impedance after matching	50 ohms						
Case Style	SMP-03 7 x 5 mm Nominal Footprint						
Lid Symbolization (YY=year, WW=week, S=shift) See note 4	RFM SF1146B YYWWS						

**Electrical Connections**

Connection	Terminals
Port 1 Hot	10
Port 1 Ground Return	1
Port 2 Hot	5
Port 2 Ground Return	6
Case Ground	All Others

**Notes:**

1. Unless noted otherwise, all specifications apply over the operating temperature range with filter soldered to the specified demonstration board with impedance matching to 50  $\Omega$  and measured with 50  $\Omega$  network analyzer.
2. Unless noted otherwise, all frequency specifications are referenced to the nominal center frequency,  $f_c$ .
3. Rejection is measured as attenuation below the minimum IL point in the passband. Rejection in final user application is dependent on PCB layout and external impedance matching design. See Application Note No. 42 for details.
4. "LRIP" or "L" after the part number indicates "low rate initial production" and "ENG" or "E" indicates "engineering prototypes."
5. The design, manufacturing process, and specifications of this filter are subject to change.
6. Tape and Reel Standard ANSI / EIA 481.
7. Either Port 1 or Port 2 may be used for either input or output in the design. However, impedances and impedance matching may vary between Port 1 and Port 2, so that the filter must always be installed in one direction per the circuit design.
8. US and international patents may apply.
9. RFM, stylized RFM logo, and RF Monolithics, Inc. are registered trademarks of RF Monolithics, Inc.
10. ©Copyright 1999, RF Monolithics Inc.
11. Electrostatic Sensitive Device. Observe precautions for handling

## Tape and Reel Specifications

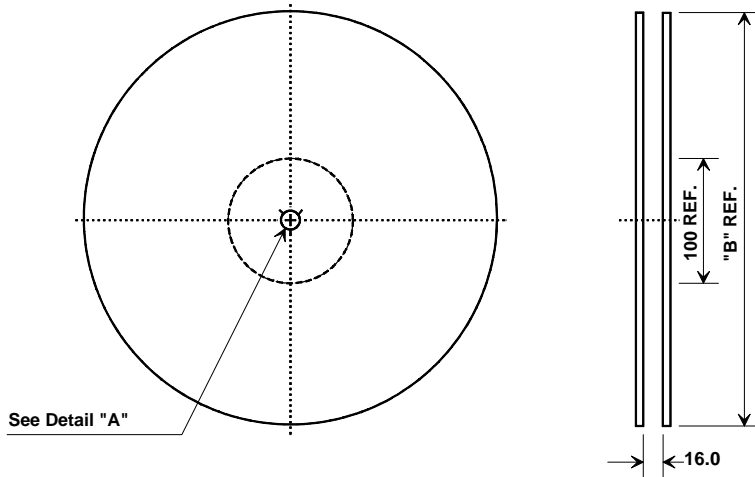

"B "		Quantity Per Reel
Inches	millimeters	
7	178	500
13	330	2000

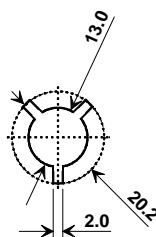

### COMPONENT ORIENTATION and DIMENSIONS

Carrier Tape Dimensions	
<b>Ao</b>	5.5 mm
<b>Bo</b>	7.5 mm
<b>Ko</b>	2.0 mm
<b>Pitch</b>	8.0 mm
<b>W</b>	16.0 mm

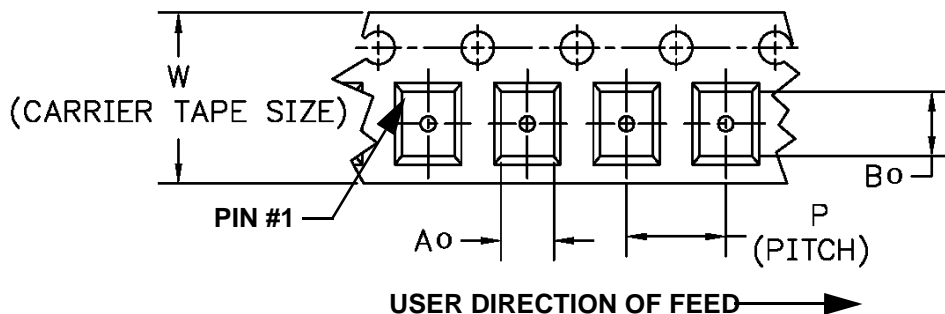
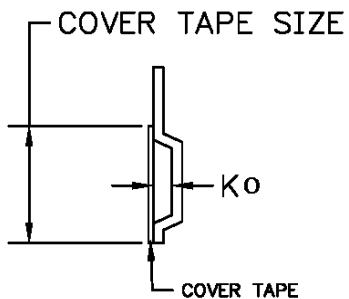

# SMP-03 Case

## 10-Terminal Ceramic Surface-Mount Case 7 x 5 mm Nominal Footprint

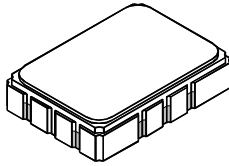

Recommended PCB Footprint

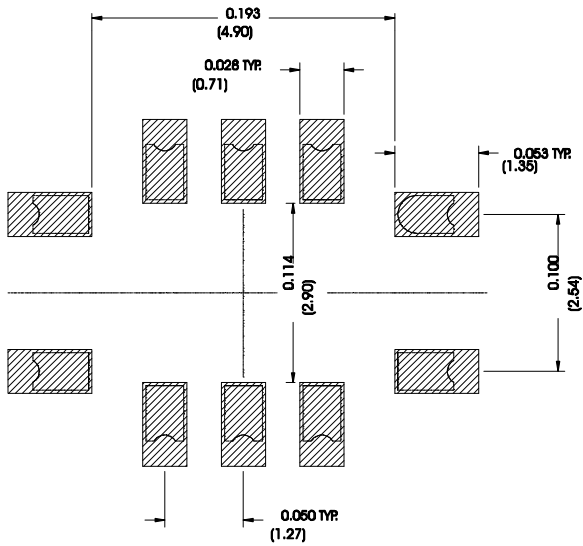

Case Dimensions						
Dimension	mm			Inches		
	Min	Nom	Max	Min	Nom	Max
A	6.80	7.00	7.20	0.268	0.276	0.283
B	4.80	5.00	5.20	0.189	0.197	0.205
C		1.65	2.00		0.065	0.079
D		0.60			0.024	
E		2.54			0.100	
H		1.0			0.039	
J		5.00			0.197	
K		3.00			0.118	
P		1.27			0.050	

Electrical Connections		
Connection		Terminals
Port 1	Input or Return	10
	Return or Input	1
Port 2	Output or Return	5
	Return or Output	6
Ground		All others
Single Ended Operation		Return is ground
Differential Operation		Return is hot

Materials	
Solder Pad Termination	Au plating 30 - 60 ulnches (76.2-152 uM) over 80-200 ulnches (203-508 uM) Ni.
Lid	Fe-Ni-Co Alloy Electroless Nickel Plate (8-11% Phosphorus) 100-200 ulnches Thick
Body	Al <sub>2</sub> O <sub>3</sub> Ceramic
Pb Free	

