

Programmable logic arrays (18 × 42 × 10)

PLUS153B/D

DESCRIPTION

The PLUS153 PLDs are high speed, combinatorial Programmable Logic Arrays. The Philips Semiconductors state-of-the-art Oxide Isolated Bipolar fabrication process is employed to produce propagation delays as short as 12ns.

The 20-pin PLUS153 devices have a programmable AND array and a programmable OR array. Unlike PAL® devices, 100% product term sharing is supported. Any of the 32 logic product terms can be connected to any or all of the 10 output OR gates. Most PAL ICs are limited to 7 AND terms per OR function; the PLUS153 devices can support up to 32 input wide OR functions.

The polarity of each output is user-programmable as either active-High or active-Low, thus allowing AND-OR or AND-NOR logic implementation. This feature adds an element of design flexibility, particularly when implementing complex decoding functions.

The PLUS153 devices are user-programmable using one of several commercially available, industry standard PLD programmers.

FEATURES

- I/O propagation delays (worst case)
 - PLUS153B – 15ns max.
 - PLUS153D – 12ns max.
- Functional superset of 16L8 and most other 20-pin combinatorial PAL devices
- Two programmable arrays
 - Supports 32 input wide OR functions
- 8 inputs
- 10 bi-directional I/O
- 42 AND gates
 - 32 logic product terms
 - 10 direction control terms
- Programmable output polarity
 - Active-High or Active-Low
- Security fuse
- 3-State outputs
- Power dissipation: 750mW (typ.)
- TTL Compatible

APPLICATIONS

- Random logic
- Code converters
- Fault detectors
- Function generators
- Address mapping
- Multiplexing

PIN CONFIGURATIONS

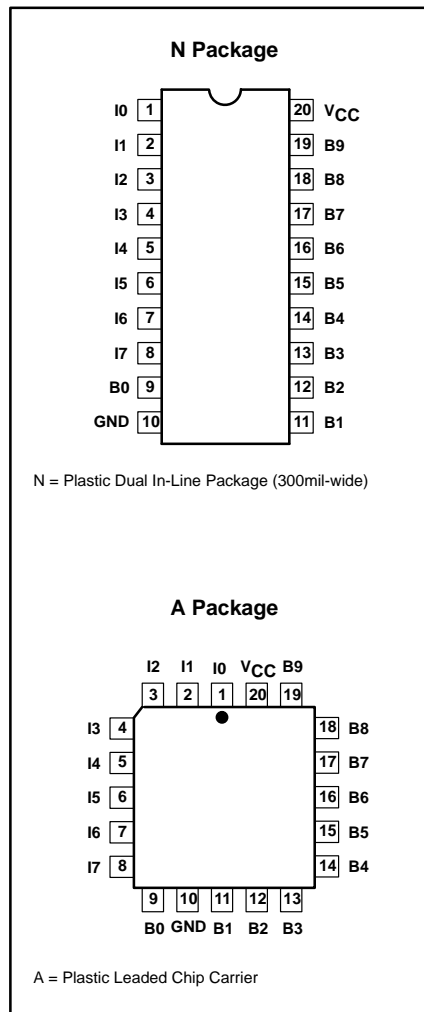

ORDERING INFORMATION

DESCRIPTION	t _{PD} (MAX)	ORDER CODE	DRAWING NUMBER
20-Pin Plastic Dual-In-Line 300mil-wide	15ns	PLUS153BN	0408D
20-Pin Plastic Dual-In-Line 300mil-wide	12ns	PLUS153DN	0408D
20-Pin Plastic Leaded Chip Carrier	15ns	PLUS153BA	0400E
20-Pin Plastic Leaded Chip Carrier	12ns	PLUS153DA	0400E

®PAL is a registered trademark of Monolithic Memories, Inc., a wholly owned subsidiary of Advanced Micro Devices Corporation.

Programmable logic arrays (18 × 42 × 10)

PLUS153B/D

LOGIC DIAGRAM

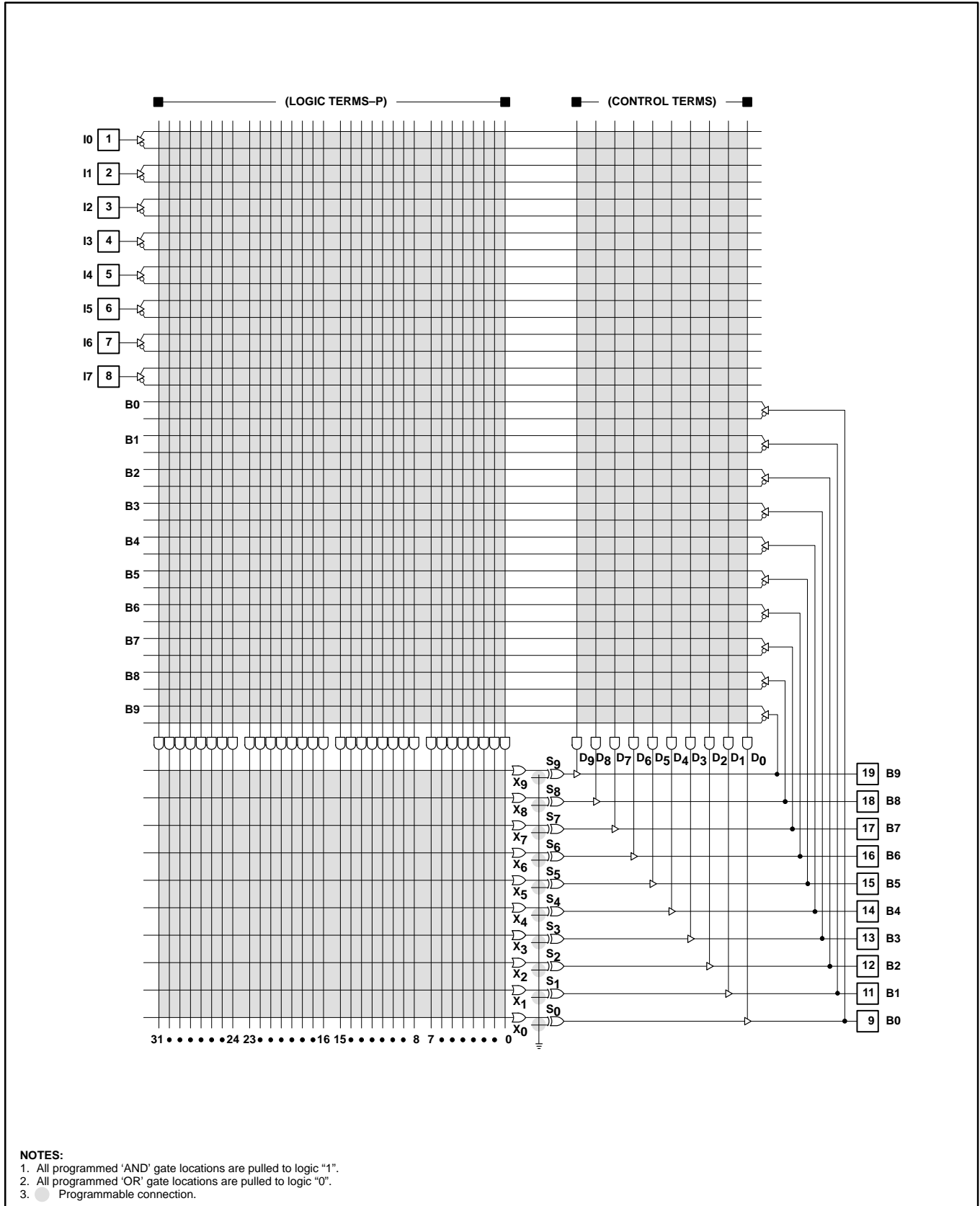

Programmable logic arrays (18 × 42 × 10)

PLUS153B/D

FUNCTIONAL DIAGRAM

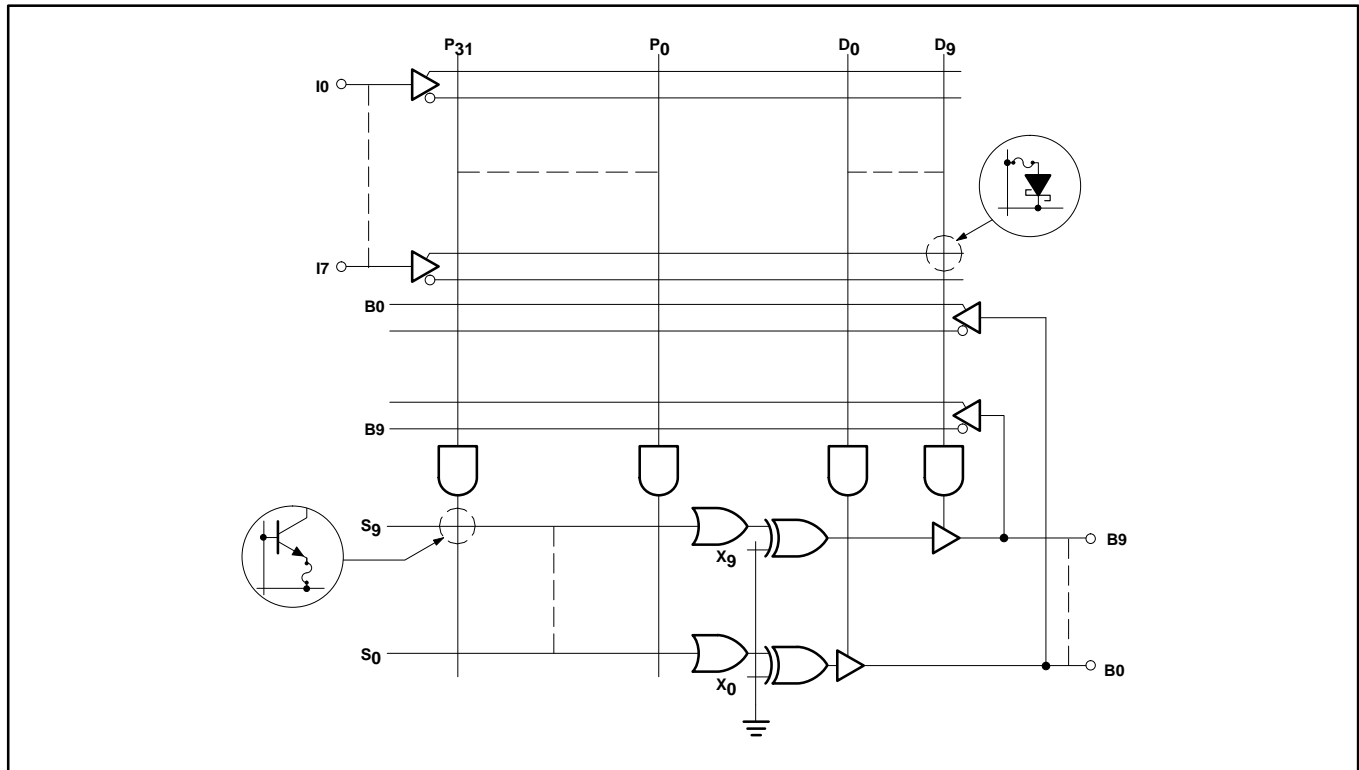

ABSOLUTE MAXIMUM RATINGS¹

SYMBOL	PARAMETER	RATING		UNIT
		MIN	MAX	
V _{CC}	Supply voltage		+7	V _{DC}
V _{IN}	Input voltage		+5.5	V _{DC}
V _{OUT}	Output voltage		+5.5	V _{DC}
I _{IN}	Input currents	-30	+30	mA
I _{OUT}	Output currents		+100	mA
T _{amb}	Operating free-air temperature range	0	+75	°C
T _{stg}	Storage temperature range	-65	+150	°C

NOTES:

- Stresses above those listed may cause malfunction or permanent damage to the device. This is a stress rating only. Functional operation at these or any other condition above those indicated in the operational and programming specification of the device is not implied.

THERMAL RATINGS

TEMPERATURE	
Maximum junction	150°C
Maximum ambient	75°C
Allowable thermal rise ambient to junction	75°C

Programmable logic arrays (18 × 42 × 10)

PLUS153B/D

DC ELECTRICAL CHARACTERISTICS

 $0^{\circ}\text{C} \leq T_{\text{amb}} \leq +75^{\circ}\text{C}$, $4.75 \leq V_{\text{CC}} \leq 5.25\text{V}$

SYMBOL	PARAMETER	TEST CONDITIONS	LIMITS			UNIT
			MIN	TYP ¹	MAX	
Input voltage²						
V_{IL}	Low	$V_{\text{CC}} = \text{MIN}$			0.8	V
V_{IH}	High	$V_{\text{CC}} = \text{MAX}$	2.0			V
V_{IC}	Clamp	$V_{\text{CC}} = \text{MIN}$, $I_{\text{IN}} = -12\text{mA}$		-0.8	-1.2	V
Output voltage²						
V_{OL}	Low ⁴	$V_{\text{CC}} = \text{MIN}$ $I_{\text{OL}} = 15\text{mA}$			0.5	V
V_{OH}	High ⁵	$I_{\text{OH}} = -2\text{mA}$	2.4			V
Input current⁹						
I_{IL}	Low	$V_{\text{CC}} = \text{MAX}$ $V_{\text{IN}} = 0.45\text{V}$			-100	μA
I_{IH}	High	$V_{\text{IN}} = V_{\text{CC}}$			40	μA
Output current						
$I_{\text{O(OFF)}}$	Hi-Z state ⁸	$V_{\text{CC}} = \text{MAX}$ $V_{\text{OUT}} = 2.7\text{V}$ $V_{\text{OUT}} = 0.45\text{V}$			80 -140	μA
I_{OS}	Short circuit ^{3, 5, 6}	$V_{\text{OUT}} = 0\text{V}$	-15		-70	mA
I_{CC}	V_{CC} supply current ⁷	$V_{\text{CC}} = \text{MAX}$		150	200	mA
Capacitance						
C_{IN}	Input	$V_{\text{CC}} = 5\text{V}$ $V_{\text{IN}} = 2.0\text{V}$		8		pF
C_{B}	I/O	$V_{\text{B}} = 2.0\text{V}$		15		pF

NOTES:

- All typical values are at $V_{\text{CC}} = 5\text{V}$, $T_{\text{amb}} = +25^{\circ}\text{C}$.
- All voltage values are with respect to network ground terminal.
- Test one at a time.
- Measured with inputs I0 – I2 = 0V, inputs I3 – I5 = 4.5V, inputs I7 = 4.5V and I6 = 10V. For outputs B0 – B4 and for outputs B5 – B9 apply the same conditions except I7 = 0V.
- Same conditions as Note 4 except I7 = +10V.
- Duration of short circuit should not exceed 1 second.
- I_{CC} is measured with inputs I0 – I7 and B0 – B9 = 0V.
- Leakage values are a combination of input and output leakage.
- I_{IL} and I_{IH} limits are for dedicated inputs only (I0 – I7).

Programmable logic arrays (18 × 42 × 10)

PLUS153B/D

AC ELECTRICAL CHARACTERISTICS

0°C ≤ T_{amb} ≤ +75°C, 4.75V ≤ V_{CC} ≤ 5.25V, R₁ = 300Ω, R₂ = 390Ω

SYMBOL	PARAMETER	FROM	TO	TEST CONDITION	LIMITS						UNIT
					PLUS153B			PLUS153D			
					MIN	TYP	MAX	MIN	TYP	MAX	
t _{PD}	Propagation Delay ²	Input +/-	Output +/-	C _L = 30pF		11	15		10	12	ns
t _{OE}	Output Enable ¹	Input +/-	Output -	C _L = 30pF		11	15		10	12	ns
t _{OD}	Output Disable ¹	Input +/-	Output +	C _L = 5pF		11	15		10	12	ns

NOTES:

- For 3-State output; output enable times are tested with C_L = 30pF to the 1.5V level, and S₁ is open for high-impedance to High tests and closed for high-impedance to Low tests. Output disable times are tested with C_L = 5pF. High-to-High impedance tests are made to an output voltage of V_T = (V_{OH} - 0.5V) with S₁ open, and Low-to-High impedance tests are made to the V_T = (V_{OL} + 0.5V) level with S₁ closed.
- All propagation delays are measured and specified under worst case conditions.

VOLTAGE WAVEFORMS

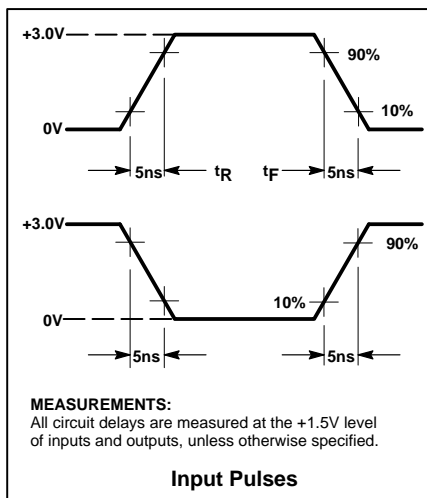

TEST LOAD CIRCUIT

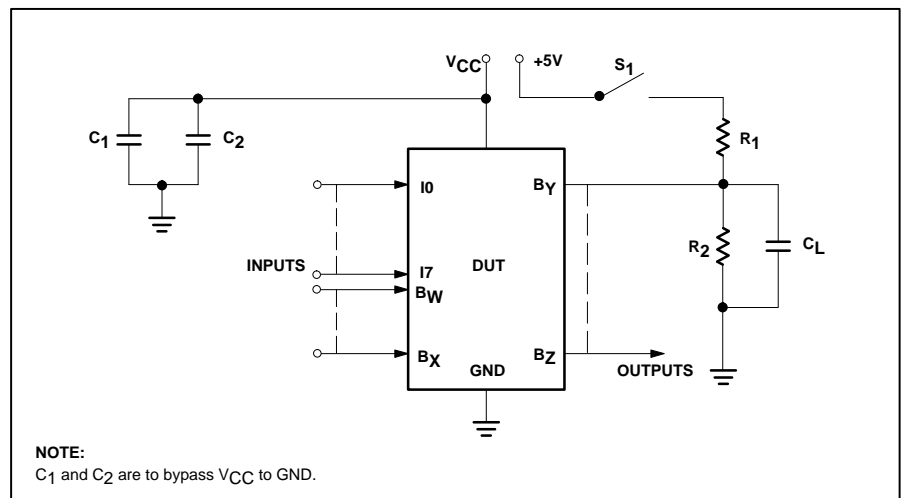

TIMING DEFINITIONS

SYMBOL	PARAMETER
t _{PD}	Propagation delay between input and output.
t _{OD}	Delay between input change and when output is off (Hi-Z or High).
t _{OE}	Delay between input change and when output reflects specified output level.

TIMING DIAGRAM

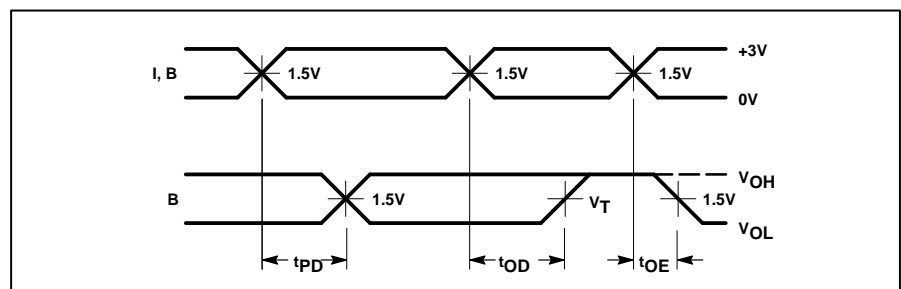

Programmable logic arrays (18 × 42 × 10)

PLUS153B/D

LOGIC PROGRAMMING

The PLUS153B/D is fully supported by industry standard (JEDEC compatible) PLD CAD tools, including Philips Semiconductors SNAP design software package. ABEL™ and CUPL™ design software packages also support the PLUS153B/D architecture.

All packages allow Boolean and state equation entry formats. SNAP, ABEL and CUPL also accept, as input, schematic capture format.

PLUS153B/D logic designs can also be generated using the program table entry format, which is detailed on the following page. This program table entry format is supported by SNAP only.

To implement the desired logic functions, the state of each logic variable from logic equations (I, B, O, P, etc.) is assigned a symbol. The symbols for TRUE, COMPLEMENT, INACTIVE, PRESET, etc., are defined below.

PROGRAMMING AND SOFTWARE SUPPORT

Refer to Section 9 (*Development Software*) and Section 10 (*Third-Party Programmer/Software Support*) of this data handbook for additional information.

OUTPUT POLARITY – (B)

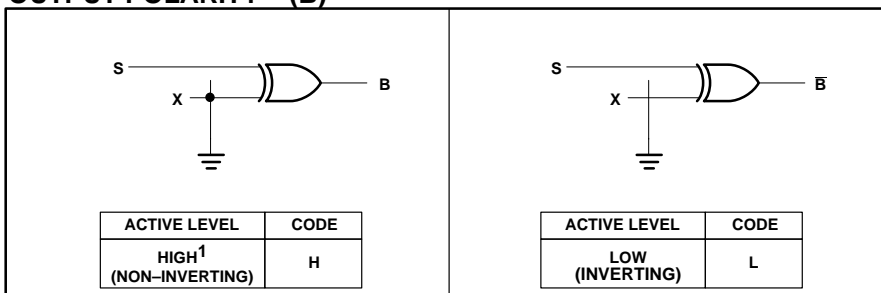

AND ARRAY – (I, B)

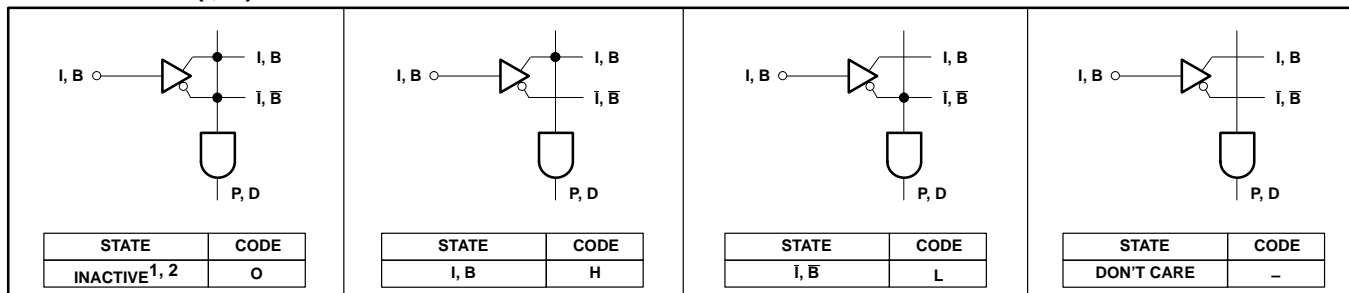

OR ARRAY – (B)

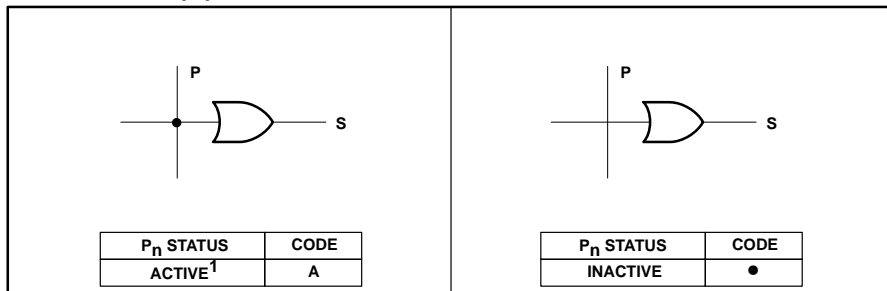

VIRGIN STATE

A factory shipped virgin device contains all fusible links intact, such that:

1. All outputs are at "H" polarity.
2. All P_n terms are disabled.
3. All P_n terms are active on all outputs.

NOTES:

1. This is the initial unprogrammed state of all links.
2. Any gate P_n will be unconditionally inhibited if both the true and complement of an input (either I or B) are left intact.

ABEL is a trademark of Data I/O Corp.
CUPL is a trademark of Logical Devices, Inc.

Programmable logic arrays (18 × 42 × 10)

PLUS153B/D

SNAP RESOURCE SUMMARY DESIGNATIONS

