

# LM285, LM385B

## Micropower Voltage Reference Diodes

The LM285/LM385 series are micropower two-terminal bandgap voltage regulator diodes. Designed to operate over a wide current range of 10  $\mu\text{A}$  to 20 mA, these devices feature exceptionally low dynamic impedance, low noise and stable operation over time and temperature. Tight voltage tolerances are achieved by on-chip trimming. The large dynamic operating range enables these devices to be used in applications with widely varying supplies with excellent regulation. Extremely low operating current make these devices ideal for micropower circuitry like portable instrumentation, regulators and other analog circuitry where extended battery life is required.

The LM285/LM385 series are packaged in a low cost TO-226AA plastic case and are available in two voltage versions of 1.235 and 2.500 V as denoted by the device suffix (see Ordering Information table). The LM285 is specified over a  $-40^{\circ}\text{C}$  to  $+85^{\circ}\text{C}$  temperature range while the LM385 is rated from  $0^{\circ}\text{C}$  to  $+70^{\circ}\text{C}$ .

The LM385 is also available in a surface mount plastic package in voltages of 1.235 and 2.500 V.

- Operating Current from 10  $\mu\text{A}$  to 20 mA
- 1.0%, 1.5%, 2.0% and 3.0% Initial Tolerance Grades
- Low Temperature Coefficient
- 1.0  $\Omega$  Dynamic Impedance
- Surface Mount Package Available

Representative Schematic Diagram

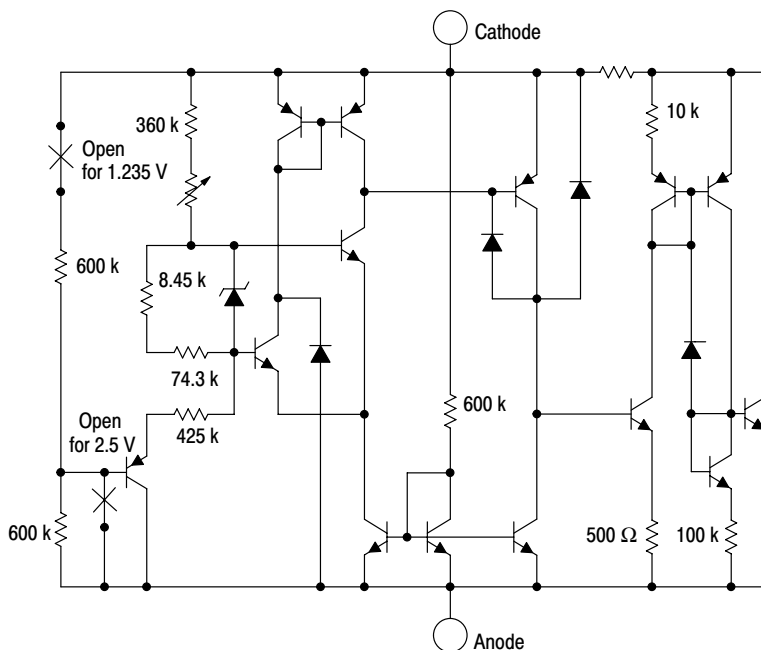

ON Semiconductor®

<http://onsemi.com>

Z SUFFIX  
PLASTIC PACKAGE  
CASE 29

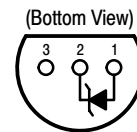

N.C.  
Cathode  
Anode

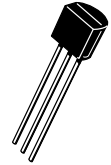

D SUFFIX  
PLASTIC PACKAGE  
CASE 751  
(SO-8)

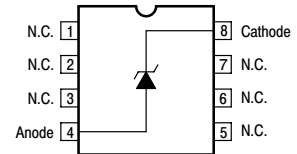

### Standard Application

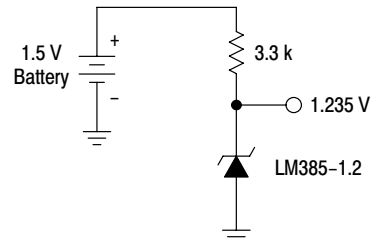

### ORDERING INFORMATION

| Device                     | Operating Temperature Range                  | Reverse Break-down Voltage | Tolerance   |
|----------------------------|--|----------------------------|-------------|
| LM285D-1.2<br>LM285Z-1.2   | $T_A = -40^{\circ}$ to $+85^{\circ}\text{C}$ | 1.235 V                    | $\pm 1.0\%$ |
| LM285D-2.5<br>LM285Z-2.5   |  | 2.500 V                    | $\pm 1.5\%$ |
| LM385BD-1.2<br>LM385BZ-1.2 | $T_A = 0^{\circ}$ to $+70^{\circ}\text{C}$   | 1.235 V                    | $\pm 1.0\%$ |
| LM385D-1.2<br>LM385Z-1.2   |  | 1.235 V                    | $\pm 2.0\%$ |
| LM385BD-2.5<br>LM385BZ-2.5 |  | 2.500 V                    | $\pm 1.5\%$ |
| LM385D-2.5<br>LM385Z-2.5   |  | 2.500 V                    | $\pm 3.0\%$ |

# LM285, LM385B

## MAXIMUM RATINGS (T<sub>A</sub> = 25°C, unless otherwise noted)

| Rating  | Symbol           | Value                    | Unit |
|---|------------------|--------------------------|------|
| Reverse Current                                       | I <sub>R</sub>   | 30                       | mA   |
| Forward Current                                       | I <sub>F</sub>   | 10                       | mA   |
| Operating Ambient Temperature Range<br>LM285<br>LM385 | T <sub>A</sub>   | - 40 to + 85<br>0 to +70 | °C   |
| Operating Junction Temperature                        | T <sub>J</sub>   | + 150                    | °C   |
| Storage Temperature Range                             | T <sub>stg</sub> | - 65 to + 150            | °C   |

## ELECTRICAL CHARACTERISTICS (T<sub>A</sub> = 25°C, unless otherwise noted)

| Characteristic  | Symbol                  | LM285-1.2                |                      |                          | LM385-1.2 / LM385B-1.2           |                          |                                  | Unit        |
|---|-------------------------|--------------------------|----------------------|--------------------------|----------------------------------|--------------------------|----------------------------------|-------------|
|   |                         | Min                      | Typ                  | Max                      | Min                              | Typ                      | Max                              |             |
| Reverse Breakdown Voltage (I <sub>Rmin</sub> ≤ I <sub>R</sub> ≤ 20 mA)<br>LM285-1.2/LM385B-1.2<br>T <sub>A</sub> = T <sub>low</sub> to T <sub>high</sub> (Note 1)<br>LM385-1.2<br>T <sub>A</sub> = T <sub>low</sub> to T <sub>high</sub> (Note 1)   | V <sub>(BR)R</sub>      | 1.223<br>1.200<br>-<br>- | 1.235<br>-<br>-<br>- | 1.247<br>1.270<br>-<br>- | 1.223<br>1.210<br>1.205<br>1.192 | 1.235<br>-<br>1.235<br>- | 1.247<br>1.260<br>1.260<br>1.273 | V           |
| Minimum Operating Current<br>T <sub>A</sub> = 25°C<br>T <sub>A</sub> = T <sub>low</sub> to T <sub>high</sub> (Note 1)   | I <sub>Rmin</sub>       | -<br>-                   | 8.0<br>-             | 10<br>20                 | -<br>-                           | 8.0<br>-                 | 15<br>20                         | μA          |
| Reverse Breakdown Voltage Change with Current<br>I <sub>Rmin</sub> ≤ I <sub>R</sub> ≤ 1.0 mA, T <sub>A</sub> = +25°C<br>T <sub>A</sub> = T <sub>low</sub> to T <sub>high</sub> (Note 1)<br>1.0 mA ≤ I <sub>R</sub> ≤ 20 mA, T <sub>A</sub> = +25°C<br>T <sub>A</sub> = T <sub>low</sub> to T <sub>high</sub> (Note 1) | ΔV <sub>(BR)R</sub>     | -<br>-<br>-<br>-         | -<br>-<br>-<br>-     | 1.0<br>1.5<br>10<br>20   | -<br>-<br>-<br>-                 | -<br>-<br>-<br>-         | 1.0<br>1.5<br>20<br>25           | mV          |
| Reverse Dynamic Impedance<br>I <sub>R</sub> = 100 μA, T <sub>A</sub> = +25°C  | Z                       | -                        | 0.6                  | -                        | -                                | 0.6                      | -                                | Ω           |
| Average Temperature Coefficient<br>10 μA ≤ I <sub>R</sub> ≤ 20 mA, T <sub>A</sub> = T <sub>low</sub> to T <sub>high</sub> (Note 1)  | ΔV <sub>(BR)R</sub> /ΔT | -                        | 80                   | -                        | -                                | 80                       | -                                | ppm/°C      |
| Wideband Noise (RMS)<br>I <sub>R</sub> = 100 μA, 10 Hz ≤ f ≤ 10 kHz   | n                       | -                        | 60                   | -                        | -                                | 60                       | -                                | μV          |
| Long Term Stability<br>I <sub>R</sub> = 100 μA, T <sub>A</sub> = +25°C ± 0.1°C  | S                       | -                        | 20                   | -                        | -                                | 20                       | -                                | ppm/<br>kHR |

# LM285, LM385B

## ELECTRICAL CHARACTERISTICS ( $T_A = 25^\circ\text{C}$ , unless otherwise noted)

| Characteristic   | Symbol                      | LM285-2.5                |                    |                          | LM385-2.5/LM385B-2.5             |                      |                                  | Unit                  |
|--|-----------------------------|--------------------------|--------------------|--------------------------|----------------------------------|----------------------|----------------------------------|-----------------------|
|  |                             | Min                      | Typ                | Max                      | Min                              | Typ                  | Max                              |                       |
| Reverse Breakdown Voltage ( $I_{Rmin} \leq I_R \leq 20 \text{ mA}$ )<br>LM285-2.5/LM385B-2.5<br>$T_A = T_{low}$ to $T_{high}$ (Note 1)<br>LM385-2.5<br>$T_A = T_{low}$ to $T_{high}$ (Note 1)  | $V_{(BR)R}$                 | 2.462<br>2.415<br>-<br>- | 2.5<br>-<br>-<br>- | 2.538<br>2.585<br>-<br>- | 2.462<br>2.436<br>2.425<br>2.400 | 2.5<br>-<br>2.5<br>- | 2.538<br>2.564<br>2.575<br>2.600 | V                     |
| Minimum Operating Current<br>$T_A = 25^\circ\text{C}$<br>$T_A = T_{low}$ to $T_{high}$ (Note 1)  | $I_{Rmin}$                  | -<br>-                   | 13<br>-            | 20<br>30                 | -<br>-                           | 13<br>-              | 20<br>30                         | $\mu\text{A}$         |
| Reverse Breakdown Voltage Change with Current<br>$I_{Rmin} \leq I_R \leq 1.0 \text{ mA}$ , $T_A = +25^\circ\text{C}$<br>$T_A = T_{low}$ to $T_{high}$ (Note 1)<br>$1.0 \text{ mA} \leq I_R \leq 20 \text{ mA}$ , $T_A = +25^\circ\text{C}$<br>$T_A = T_{low}$ to $T_{high}$ (Note 1) | $\Delta V_{(BR)R}$          | -<br>-<br>-<br>-         | -<br>-<br>-<br>-   | 1.0<br>1.5<br>10<br>20   | -<br>-<br>-<br>-                 | -<br>-<br>-<br>-     | 2.0<br>2.5<br>20<br>25           | mV                    |
| Reverse Dynamic Impedance<br>$I_R = 100 \mu\text{A}$ , $T_A = +25^\circ\text{C}$   | Z                           |                          | 0.6                | -                        | -                                | 0.6                  | -                                | $\Omega$              |
| Average Temperature Coefficient<br>$20 \mu\text{A} \leq I_R \leq 20 \text{ mA}$ , $T_A = T_{low}$ to $T_{high}$ (Note 1)   | $\Delta V_{(BR)R}/\Delta T$ | -                        | 80                 | -                        | -                                | 80                   | -                                | ppm/ $^\circ\text{C}$ |
| Wideband Noise (RMS)<br>$I_R = 100 \mu\text{A}$ , $10 \text{ Hz} \leq f \leq 10 \text{ kHz}$   | n                           | -                        | 120                | -                        | -                                | 120                  | -                                | $\mu\text{V}$         |
| Long Term Stability<br>$I_R = 100 \mu\text{A}$ , $T_A = +25^\circ\text{C} \pm 0.1^\circ\text{C}$   | S                           | -                        | 20                 | -                        | -                                | 20                   | -                                | ppm/<br>kHR           |

**NOTES:** 1.  $T_{low} = -40^\circ\text{C}$  for LM285-1.2, LM285-2.5  
 $= 0^\circ\text{C}$  for LM385-1.2, LM385B-1.2, LM385-2.5, LM385B-2.5

$T_{high} = +85^\circ\text{C}$  for LM285-1.2, LM285-2.5  
 $= +70^\circ\text{C}$  for LM385-1.2, LM385B-1.2, LM385-2.5, LM385B-2.5

# LM285, LM385B

## TYPICAL PERFORMANCE CURVES FOR LM285-1.2/385-1.2/385B-1.2

Figure 1. Reverse Characteristics

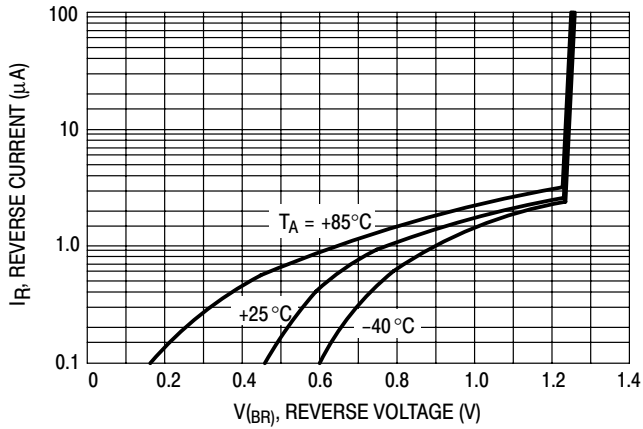

Figure 2. Reverse Characteristics

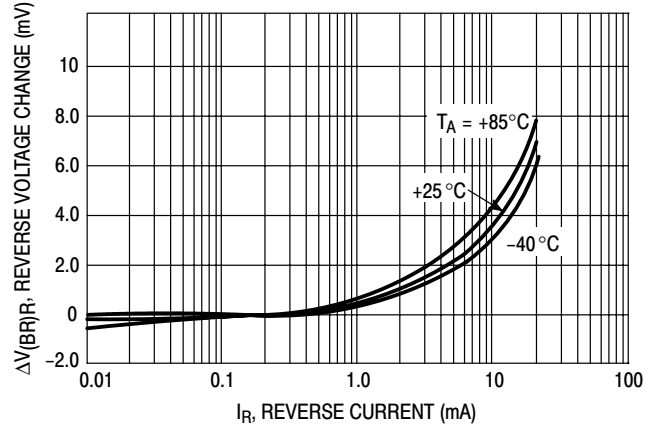

Figure 3. Forward Characteristics

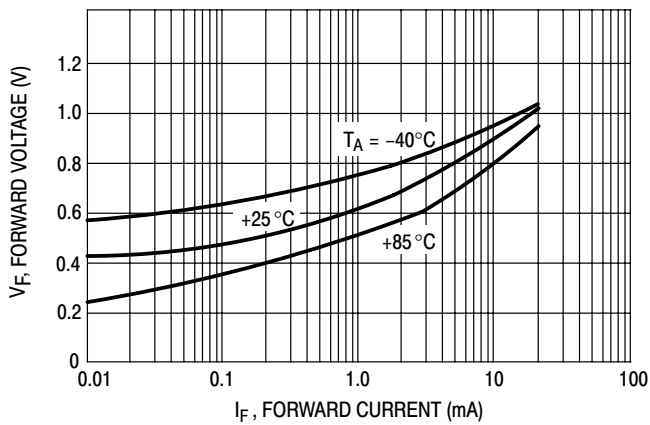

Figure 4. Temperature Drift

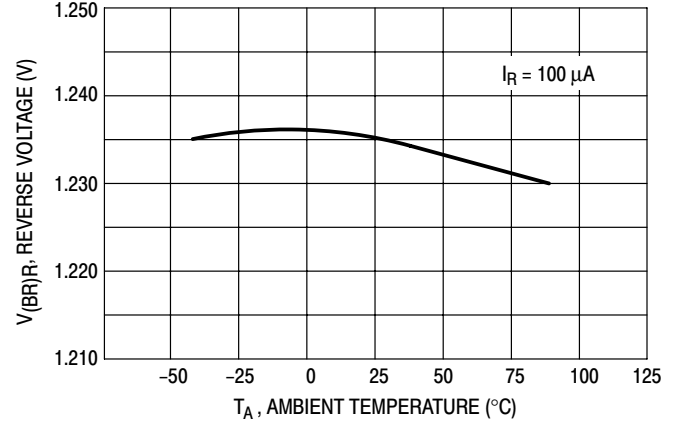

Figure 5. Noise Voltage

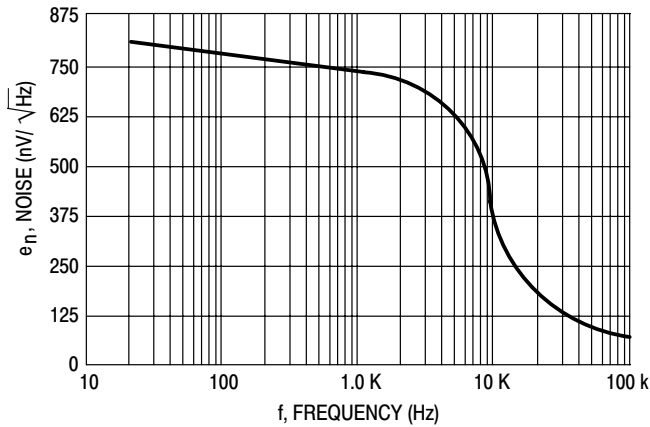
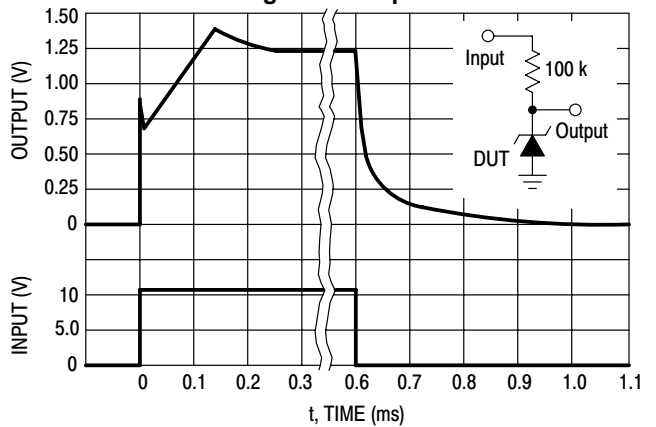

Figure 6. Response Time



# LM285, LM385B

## TYPICAL PERFORMANCE CURVES FOR LM285-2.5/385-2.5/385B-2.5

Figure 7. Reverse Characteristics

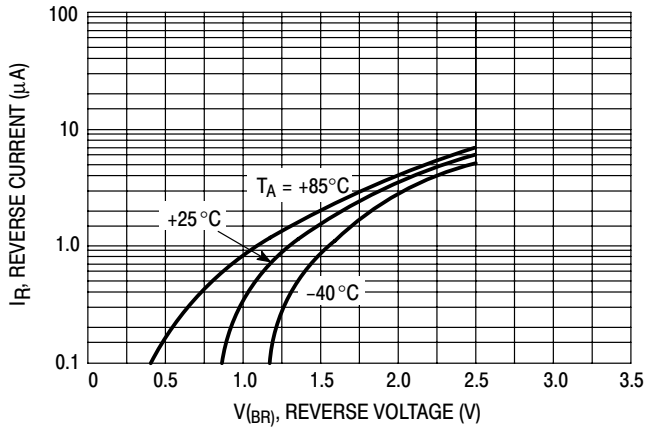

Figure 8. Reverse Characteristics

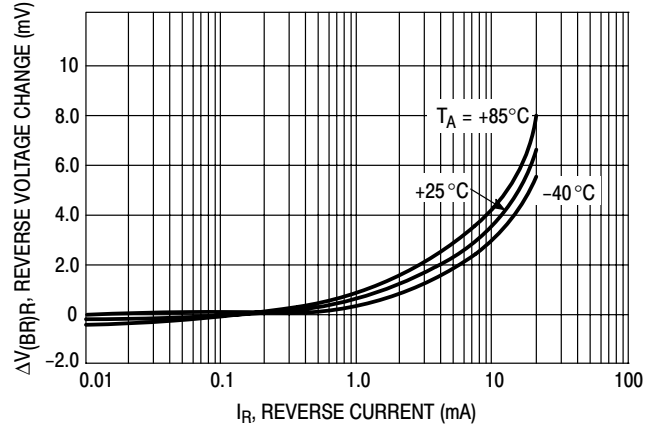

Figure 9. Forward Characteristics

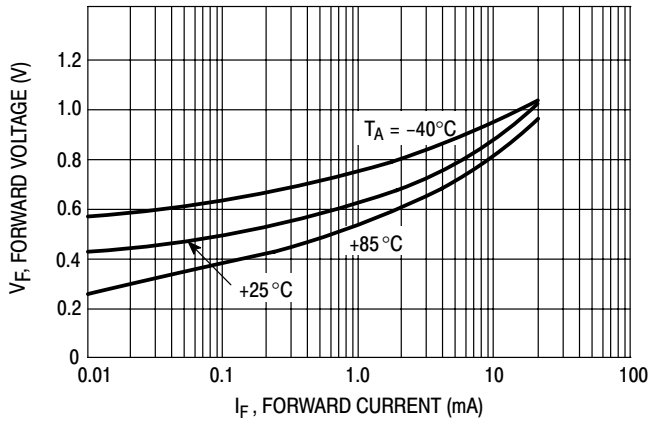

Figure 10. Temperature Drift

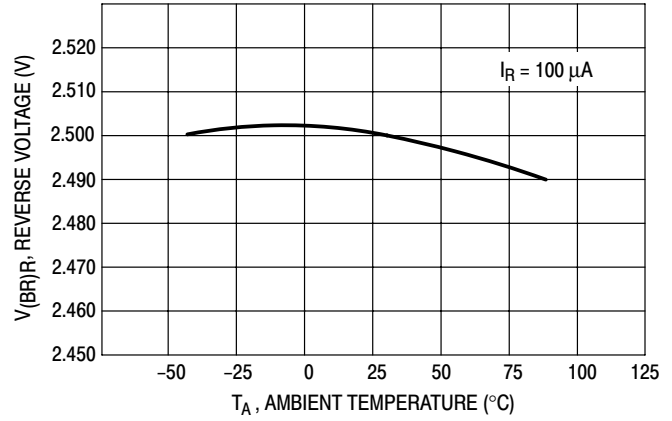

Figure 11. Noise Voltage

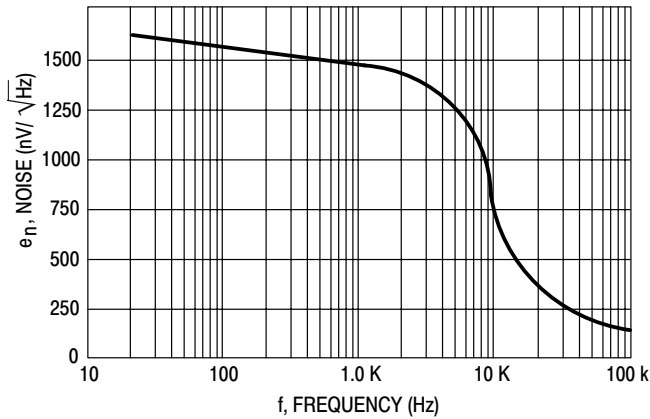
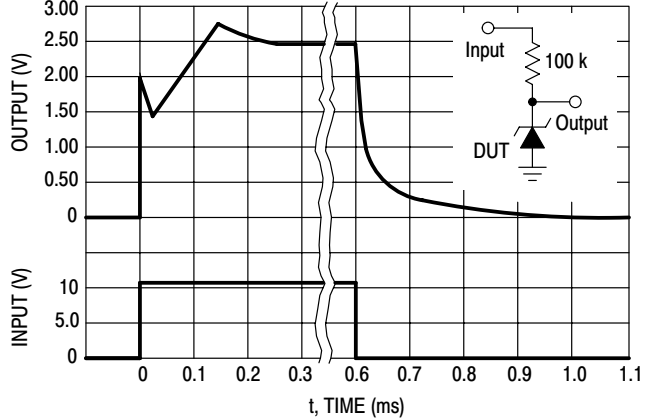

Figure 12. Response Time



# LM285, LM385B

## PACKAGE DIMENSIONS

### PLASTIC PACKAGE Z SUFFIX CASE 29-11 ISSUE AL

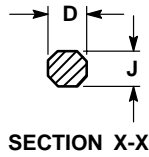
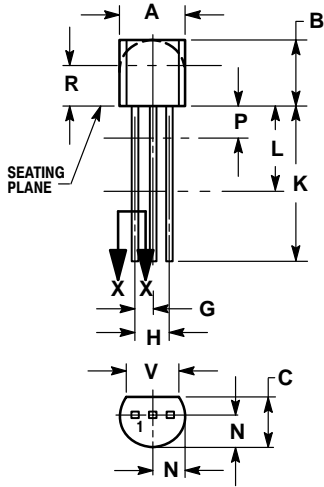

NOTES:

1. DIMENSIONING AND TOLERANCING PER ANSI Y14.5M, 1982.
2. CONTROLLING DIMENSION: INCH.
3. CONTOUR OF PACKAGE BEYOND DIMENSION R IS UNCONTROLLED.
4. LEAD DIMENSION IS UNCONTROLLED IN P AND BEYOND DIMENSION K MINIMUM.

| DIM | INCHES |       | MILLIMETERS |       |
|-----|--------|-------|-------------|-------|
|     | MIN    | MAX   | MIN         | MAX   |
| A   | 0.175  | 0.205 | 4.45        | 5.20  |
| B   | 0.170  | 0.210 | 4.32        | 5.33  |
| C   | 0.125  | 0.165 | 3.18        | 4.19  |
| D   | 0.016  | 0.021 | 0.407       | 0.533 |
| G   | 0.045  | 0.055 | 1.15        | 1.39  |
| H   | 0.095  | 0.105 | 2.42        | 2.66  |
| J   | 0.015  | 0.020 | 0.39        | 0.50  |
| K   | 0.500  | ---   | 12.70       | ---   |
| L   | 0.250  | ---   | 6.35        | ---   |
| N   | 0.080  | 0.105 | 2.04        | 2.66  |
| P   | ---    | 0.100 | ---         | 2.54  |
| R   | 0.115  | ---   | 2.93        | ---   |
| V   | 0.135  | ---   | 3.43        | ---   |

### PLASTIC PACKAGE D SUFFIX CASE 751-07 ISSUE AA

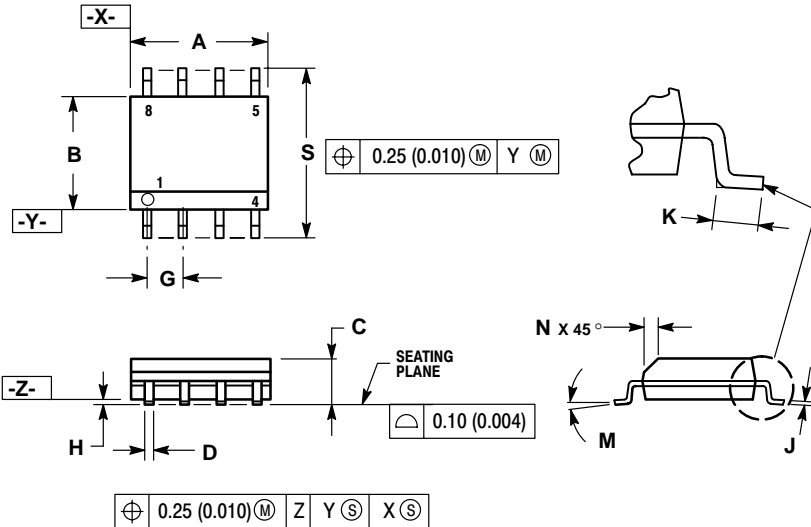

NOTES:

1. DIMENSIONING AND TOLERANCING PER ANSI Y14.5M, 1982.
2. CONTROLLING DIMENSION: MILLIMETER.
3. DIMENSION A AND B DO NOT INCLUDE MOLD PROTRUSION.
4. MAXIMUM MOLD PROTRUSION 0.15 (0.006) PER SIDE.
5. DIMENSION D DOES NOT INCLUDE DAMBAR PROTRUSION. ALLOWABLE DAMBAR PROTRUSION SHALL BE 0.127 (0.005) TOTAL IN EXCESS OF THE D DIMENSION AT MAXIMUM MATERIAL CONDITION.
6. 751-01 THRU 751-06 ARE OBSOLETE. NEW STANDARD IS 751-07.

| DIM | MILLIMETERS |      | INCHES    |       |
|-----|-------------|------|-----------|-------|
|     | MIN         | MAX  | MIN       | MAX   |
| A   | 4.80        | 5.00 | 0.189     | 0.197 |
| B   | 3.80        | 4.00 | 0.150     | 0.157 |
| C   | 1.35        | 1.75 | 0.053     | 0.069 |
| D   | 0.33        | 0.51 | 0.013     | 0.020 |
| G   | 1.27 BSC    |      | 0.050 BSC |       |
| H   | 0.10        | 0.25 | 0.004     | 0.010 |
| J   | 0.19        | 0.25 | 0.007     | 0.010 |
| K   | 0.40        | 1.27 | 0.016     | 0.050 |
| M   | 0°          | 8°   | 0°        | 8°    |
| N   | 0.25        | 0.50 | 0.010     | 0.020 |
| S   | 5.80        | 6.20 | 0.228     | 0.244 |

## Notes

# LM285, LM385B

SENSEFET is a trademark of Semiconductor Components Industries, LLC.

**ON Semiconductor** and  are registered trademarks of Semiconductor Components Industries, LLC (SCILLC). SCILLC reserves the right to make changes without further notice to any products herein. SCILLC makes no warranty, representation or guarantee regarding the suitability of its products for any particular purpose, nor does SCILLC assume any liability arising out of the application or use of any product or circuit, and specifically disclaims any and all liability, including without limitation special, consequential or incidental damages. "Typical" parameters which may be provided in SCILLC data sheets and/or specifications can and do vary in different applications and actual performance may vary over time. All operating parameters, including "Typicals" must be validated for each customer application by customer's technical experts. SCILLC does not convey any license under its patent rights nor the rights of others. SCILLC products are not designed, intended, or authorized for use as components in systems intended for surgical implant into the body, or other applications intended to support or sustain life, or for any other application in which the failure of the SCILLC product could create a situation where personal injury or death may occur. Should Buyer purchase or use SCILLC products for any such unintended or unauthorized application, Buyer shall indemnify and hold SCILLC and its officers, employees, subsidiaries, affiliates, and distributors harmless against all claims, costs, damages, and expenses, and reasonable attorney fees arising out of, directly or indirectly, any claim of personal injury or death associated with such unintended or unauthorized use, even if such claim alleges that SCILLC was negligent regarding the design or manufacture of the part. SCILLC is an Equal Opportunity/Affirmative Action Employer.

## PUBLICATION ORDERING INFORMATION

### Literature Fulfillment:

Literature Distribution Center for ON Semiconductor  
P.O. Box 5163, Denver, Colorado 80217 USA  
**Phone:** 303-675-2175 or 800-344-3860 Toll Free USA/Canada  
**Fax:** 303-675-2176 or 800-344-3867 Toll Free USA/Canada  
**Email:** ONlit@hibbertco.com

**N. American Technical Support:** 800-282-9855 Toll Free USA/Canada

**JAPAN:** ON Semiconductor, Japan Customer Focus Center  
2-9-1 Kamimeguro, Meguro-ku, Tokyo, Japan 153-0051  
**Phone:** 81-3-5773-3850

**ON Semiconductor Website:** <http://onsemi.com>

For additional information, please contact your local Sales Representative.