

LM6104

Quad Gray Scale Current Feedback Amplifier

General Description

The LM6104 quad amplifier meets the requirements of battery operated liquid crystal displays by providing high speed while maintaining low power consumption.

Combining this high speed with high integration, the LM6104 conserves valuable board space in portable systems with a cost effective, surface mount quad package.

Built on National's advanced high speed VIP™ (Vertically Integrated PNP) process, the LM6104 current feedback architecture is easily compensated for speed and loading conditions. These features make the LM6104 ideal for buffering grey levels in liquid crystal displays.

Features (Typical unless otherwise noted)

- Low power $I_S = 875 \mu A/\text{amplifier}$
- Slew rate $100V/\mu s$
- -3dB bandwidth ($R_F = 1 k\Omega$) 30 MHz
- High output drive $\pm 5V \text{ into } 100\Omega$
- Wide operating range $V_S = 5V \text{ to } \pm 12V$
- High integration Quad surface mount

Applications

- Grey level buffer for liquid crystal displays
- Column buffer for portable LCDs
- Video distribution amplifiers, video line drivers
- Hand-held, high speed signal conditioning

Typical Application

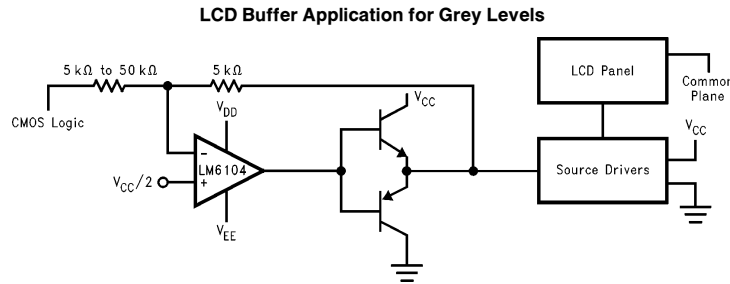

TL/H/11979-1

Connection Diagram

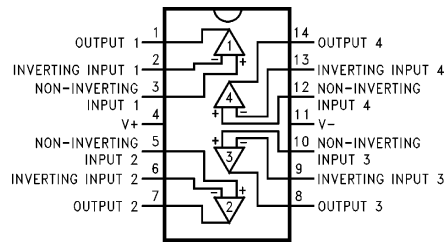

TL/H/11979-2

Order Number LM6104M
See NS Package Number M14A

VIP™ is a trademark of National Semiconductor Corporation.

Absolute Maximum Ratings (Note 1)

If Military/Aerospace specified devices are required, please contact the National Semiconductor Sales Office/Distributors for availability and specifications.

Supply Voltage	24V
Differential Input Voltage	±6V
Input Voltage	± Supply Voltage
Inverting Input Current	15 mA
Soldering Information	
Vapor Phase (60s)	215°C
Infrared (15s)	220°C

Storage Temperature Range	-65°C ≤ T _J ≤ +150°C
Maximum Junction Temperature	150°C
ESD Rating (Note 2)	2000V

Operating Ratings

Supply Voltage Range	4.75V to 24V
Junction Temperature Range (Note 3)	-20° ≤ T _J ≤ +80°C
LM6104M	

Electrical Characteristics

The following specifications apply for V₊ = 8V, V₋ = -5V, R_L = R_F = 2 kΩ and 0° ≤ T_J ≤ 60°C unless otherwise noted.

Symbol	Parameter	Conditions	LM6104M		Units
			Typical (Note 4)	Limits (Note 5)	
V _{OS}	Input Offset Voltage		10	30	mV max
I _B	Inverting Input Bias Current		5.0	20	μA max
	Non-Inverting Input Bias Current		0.5	2	μA max
I _S	Supply Current	V _O = 0V	3.5	4.0	mA max
I _{SC}	Output Source Current	V _O = 0V I _{IN(-)} = -100 μA	60	45	mA min
	Output Sink Current	V _O = 0V I _{IN(-)} = 100 μA	60	45	mA min
V _O	Positive Output Swing	I _{IN(-)} = -100 μA	6.5	6.1	V min
	Negative Output Swing	I _{IN(-)} = 100 μA	-3.5	-3.1	V max
PSRR	Power Supply Rejection Ratio	V _S = ±4 to ±10V	70	60	dB min
		100 mV pp @ 100 kHz	40	30	dB min
R _T	Transresistance		10	5	MΩ min
SR	Slew Rate	(Note 6)	100	55	V/μs min
BW	Bandwidth	A _V = -1 R _{IN} = R _F = 2 kΩ	7.5	5.0	MHz
	Amp-to-Amp Isolation	R _L = 2 kΩ F = 1 MHz	60		dB
CMVR	Common Mode Voltage Range		V ⁺ - 1.4V V ⁻ + 1.4V		V
CMRR	Common Mode Rejection Ratio		60		dB
t _S	Settling Time	0.05%, 5V Step, A _V = -1 R _F = R _S = 2 kΩ, V _S = ±5V	240		ns

Note 1: Absolute Maximum Ratings indicate limits beyond which damage to the device may occur. DC and AC electrical specifications do not apply when operating the device beyond its rated operating conditions. Operating ratings indicate conditions the device is intended to be functional, but device parameter specifications may not be guaranteed under the conditions.

Note 2: Human body model 1.5 kΩ and 100 pF. This is a class 2 device rating.

Note 3: Thermal resistance of the SO package is 98°C/W. When operating at T_A = 80°C, maximum power dissipation is 700 mW.

Note 4: Typical values represent the most likely parametric norm.

Note 5: All limits guaranteed at operating temperature extremes.

Note 6: A_V = -1 with R_{IN} = R_F = 2 kΩ. Slew rate is calculated from the 25% to the 75% point on both rising and falling edges. Output swing is -0.6V to +5.6V and 5.6V to 0.6V.

Typical Performance Characteristics

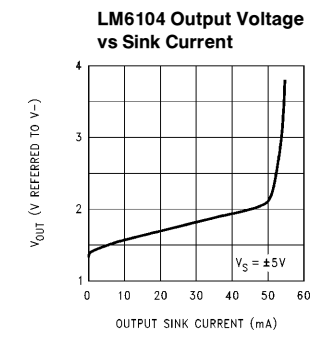
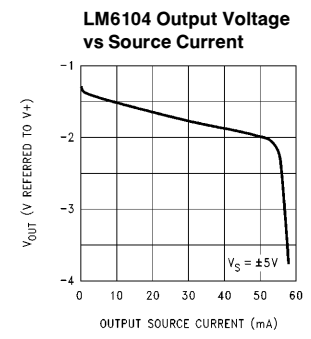
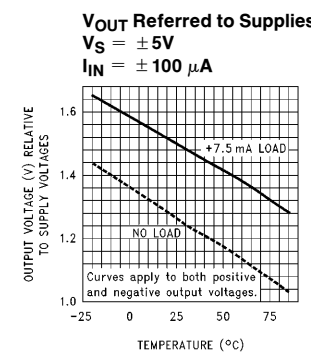
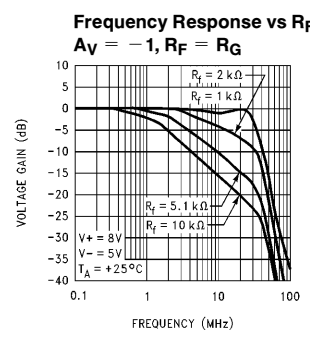
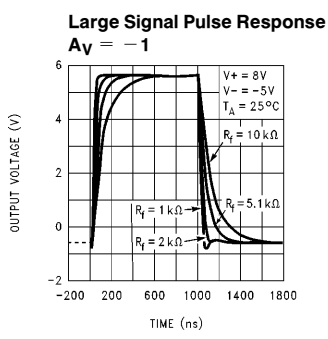
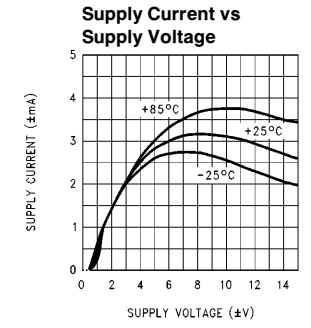
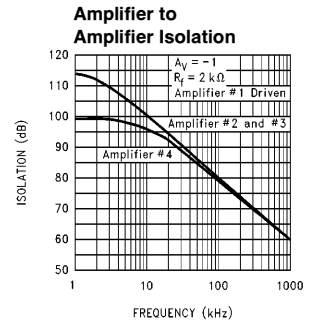
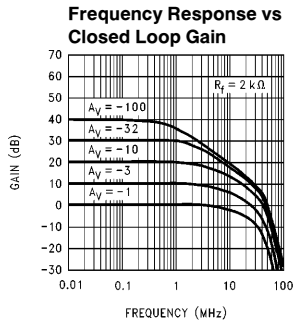

TL/H/11979-3

Applications Information

CURRENT FEEDBACK TOPOLOGY

The small-signal bandwidth of conventional voltage feedback amplifiers is inversely proportional to the closed-loop gain based on the gain-bandwidth concept. In contrast, the current feedback amplifier topology, such as the LM6104, enables a signal bandwidth that is relatively independent of the amplifier's gain (see typical curve Frequency Response vs Closed Loop Gain).

FEEDBACK RESISTOR SELECTION: R_F

Current feedback amplifier bandwidth and slew rate are controlled by R_F . R_F and the amplifier's internal compensation capacitor set the dominant pole in the frequency response. The amplifier, therefore, always requires a feedback resistor, even in unity gain.

Bandwidth and slew rate are inversely proportional to the value of R_F (see typical curve Frequency Response vs R_F). This makes the amplifier especially easy to compensate for a desired pulse response (see typical curve Large Signal Pulse Response). Increased capacitive load driving capability is also achieved by increasing the value of R_F .

The LM6104 has guaranteed performance with a feedback resistor of 2 k Ω .

CAPACITIVE FEEDBACK

It is common to place a small lead capacitor in parallel with feedback resistance to compensate voltage feedback amplifiers. Do not place a capacitor across R_F to limit the bandwidth of current feedback amplifiers. The dynamic impedance of capacitors in the feedback path of the LM6104, as with any current feedback amplifier, will cause instability.



Physical Dimensions inches (millimeters)

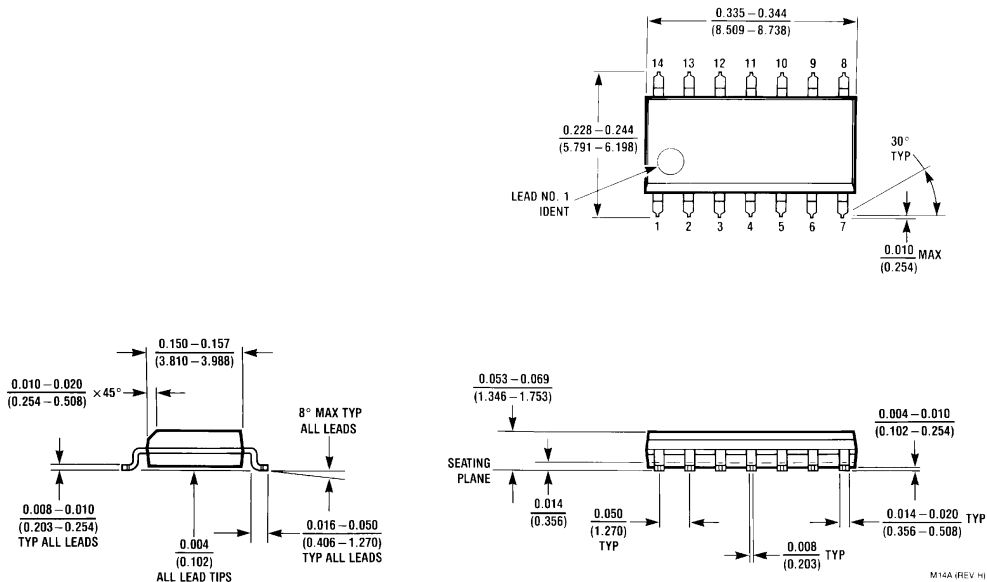

14-Pin SO Package
Order Number LM6104M
NS Package Number M14A

LIFE SUPPORT POLICY

NATIONAL'S PRODUCTS ARE NOT AUTHORIZED FOR USE AS CRITICAL COMPONENTS IN LIFE SUPPORT DEVICES OR SYSTEMS WITHOUT THE EXPRESS WRITTEN APPROVAL OF THE PRESIDENT OF NATIONAL SEMICONDUCTOR CORPORATION. As used herein:

1. Life support devices or systems are devices or systems which, (a) are intended for surgical implant into the body, or (b) support or sustain life, and whose failure to perform, when properly used in accordance with instructions for use provided in the labeling, can be reasonably expected to result in a significant injury to the user.
2. A critical component is any component of a life support device or system whose failure to perform can be reasonably expected to cause the failure of the life support device or system, or to affect its safety or effectiveness.



National Semiconductor Corporation
 1111 West Bardin Road
 Arlington, TX 76017
 Tel: 1(800) 272-9959
 Fax: 1(800) 737-7018

National Semiconductor Europe
 Fax: (+49) 0-180-530 85 86
 Email: cnjwge@tevm2.nsc.com
 Deutsch Tel: (+49) 0-180-530 85 85
 English Tel: (+49) 0-180-532 78 32
 Français Tel: (+49) 0-180-532 93 58
 Italiano Tel: (+49) 0-180-534 16 80

National Semiconductor Hong Kong Ltd.
 19th Floor, Straight Block,
 Ocean Centre, 5 Canton Rd.
 Tsimshatsui, Kowloon
 Hong Kong
 Tel: (852) 2737-1600
 Fax: (852) 2736-9960

National Semiconductor Japan Ltd.
 Tel: 81-043-299-2309
 Fax: 81-043-299-2408

National does not assume any responsibility for use of any circuitry described, no circuit patent licenses are implied and National reserves the right at any time without notice to change said circuitry and specifications.