

# 100363

## Low Power Dual 8-Input Multiplexer

### General Description

The 100363 is a dual 8-input multiplexer. The Data Select ( $S_n$ ) inputs determine which bit ( $A_n$  and  $B_n$ ) will be presented at the outputs ( $Z_a$  and  $Z_b$ , respectively). The same bit (0–7) will be selected for both the  $Z_a$  and  $Z_b$  output. All inputs have 50 k $\Omega$  pulldown resistors.

- 2000V ESD protection
- Pin/function compatible with 100163
- Voltage compensated operating range =  $-4.2V$  to  $-5.7V$
- Standard Microcircuit Drawing (SMD) 5962-9165501

### Features

- 50% power reduction of the 100163

### Logic Symbol

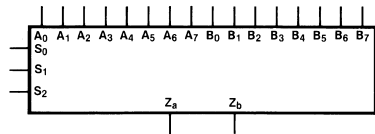

DS100310-1

Pin Names	Description
$S_0$ – $S_2$	Data Select Inputs
$A_0$ – $A_7$	A Data Inputs
$B_0$ – $B_7$	B Data Inputs
$Z_a$ , $Z_b$	Data Outputs

### Connection Diagrams

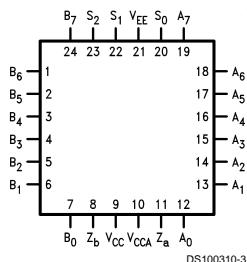
**24-Pin Quad Cerpak**

DS100310-3

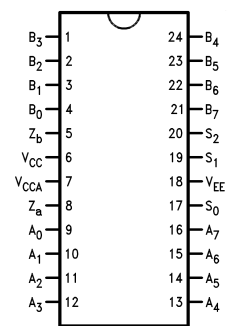
**24-Pin DIP**

DS100310-2

# Logic Diagram

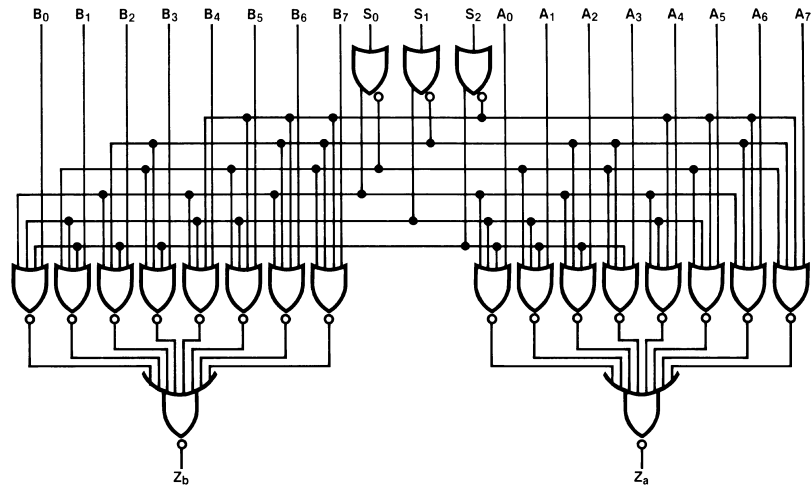

DS100310-5

## Truth Table

Inputs											Outputs	
Select			Data								Z <sub>a</sub>	Z <sub>b</sub>
S <sub>2</sub>	S <sub>1</sub>	S <sub>0</sub>	A <sub>7</sub> B <sub>7</sub>	A <sub>6</sub> B <sub>6</sub>	A <sub>5</sub> B <sub>5</sub>	A <sub>4</sub> B <sub>4</sub>	A <sub>3</sub> B <sub>3</sub>	A <sub>2</sub> B <sub>2</sub>	A <sub>1</sub> B <sub>1</sub>	A <sub>0</sub> B <sub>0</sub>		
L	L	L								L	L	
L	L	L								H	H	
L	L	H							L		L	
L	L	H							H		H	
L	H	L						L			L	
L	H	L						H			H	
L	H	H					L				L	
L	H	H					H				H	
H	L	L				L					L	
H	L	L				H					H	
H	L	H			L						L	
H	L	H			H						H	
H	H	L		L							L	
H	H	L		H							H	
H	H	H	L								L	
H	H	H	H								H	

H = HIGH Voltage Level  
 L = LOW Voltage Level  
 Blank = X = Don't Care

## Absolute Maximum Ratings (Note 1)

If Military/Aerospace specified devices are required, please contact the National Semiconductor Sales Office/Distributors for availability and specifications.

Above which the useful life may be impaired

Storage Temperature (T <sub>STG</sub> )	-65°C to +150°C
Maximum Junction Temperature (T <sub>J</sub> )	
Ceramic	+175°C
V <sub>EE</sub> Pin Potential to Ground Pin	-7.0V to +0.5V
Input Voltage (DC)	V <sub>EE</sub> to +0.5V
Output Current (DC Output HIGH)	-50 mA

ESD (Note 2)

≥2000V

## Recommended Operating Conditions

Case Temperature (T <sub>C</sub> )	
Military	-55°C to +125°C
Supply Voltage (V <sub>EE</sub> )	-5.7V to -4.2V

**Note 1:** Absolute maximum ratings are those values beyond which the device may be damaged or have its useful life impaired. Functional operation under these conditions is not implied.

**Note 2:** ESD testing conforms to MIL-STD-883, Method 3015.

## Military Version DC Electrical Characteristics

V<sub>EE</sub> = -4.2V to -5.7V, V<sub>CC</sub> = V<sub>CCA</sub> = GND, T<sub>C</sub> = -55°C to +125°C

Symbol	Parameter	Min	Max	Units	T <sub>C</sub>	Conditions	Note	
V <sub>OH</sub>	Output HIGH Voltage	-1025	-870	mV	0°C to +125°C	V <sub>IN</sub> = V <sub>IH</sub> (Max) or V <sub>IL</sub> (Min)	Loading with 50Ω to -2.0V	(Notes 3, 4, 5)
		-1085	-870	mV	-55°C			
V <sub>OL</sub>	Output LOW Voltage	-1830	-1620	mV	0°C to +125°C			
		-1830	-1555	mV	-55°C			
V <sub>OHC</sub>	Output HIGH Voltage	-1035		mV	0°C to +125°C	V <sub>IN</sub> = V <sub>IH</sub> (Min) or V <sub>IL</sub> (Max)	Loading with 50Ω to -2.0V	(Notes 3, 4, 5)
		-1085		mV	-55°C			
V <sub>OLC</sub>	Output LOW Voltage		-1610	mV	0°C to +125°C			
			-1555	mV	-55°C			
V <sub>IH</sub>	Input HIGH Voltage	-1165	-870	mV	-55°C to +125°C	Guaranteed HIGH Signal for All Inputs	(Notes 3, 4, 5, 6)	
V <sub>IL</sub>	Input LOW Voltage	-1830	-1475	mV	-55°C to +125°C	Guaranteed LOW Signal for All Inputs	(Notes 3, 4, 5, 6)	
I <sub>IL</sub>	Input LOW Current	0.50		μA	-55°C to +125°C	V <sub>EE</sub> = -4.2V V <sub>IN</sub> = V <sub>IL</sub> (Min)	(Notes 3, 4, 5)	
I <sub>IH</sub>	Input HIGH Current	S <sub>n</sub>	265	μA	0°C to +125°C	V <sub>EE</sub> = -5.7V V <sub>IN</sub> = V <sub>IH</sub> (Max)	(Notes 3, 4, 5)	
			A <sub>n</sub> , B <sub>n</sub>	340				
		S <sub>n</sub>	385	μA	-55°C			
			A <sub>n</sub> , B <sub>n</sub>	490				
I <sub>EE</sub>	Power Supply Current	-87	-30	mA	-55°C to +125°C	Inputs Open	(Notes 3, 4, 5)	

**Note 3:** F100K 300 Series cold temperature testing is performed by temperature soaking (to guarantee junction temperature equals -55°C), then testing immediately without allowing for the junction temperature to stabilize due to heat dissipation after power-up. This provides "cold start" specs which can be considered a worst case condition at cold temperatures.

**Note 4:** Screen tested 100% on each device at -55°C, +25°C, and +125°C, Subgroups 1, 2, 3, 7, and 8.

**Note 5:** Sample tested (Method 5005, Table I) on each manufactured lot at -55°C, +25°C, and +125°C, Subgroups A1, 2, 3, 7, and 8.

**Note 6:** Guaranteed by applying specified input condition and testing V<sub>OH</sub>/V<sub>OL</sub>.

## AC Electrical Characteristics

$V_{EE} = -4.2V$  to  $-5.7V$ ,  $V_{CC} = V_{CCA} = GND$

Symbol	Parameter	$T_c = -55^\circ C$		$T_c = +25^\circ C$		$T_c = +125^\circ C$		Units	Conditions	Notes
		Min	Max	Min	Max	Min	Max			
$t_{PLH}$	Propagation Delay	0.50	2.40	0.60	2.30	0.70	3.00	ns	Figure 1 and Figure 2	(Notes 7, 8, 9)
$t_{PHL}$	$A_0-A_7, B_0-B_7$ to Output									
$t_{PLH}$	Propagation Delay	0.80	3.00	0.90	2.80	0.80	3.40	ns		
$t_{PHL}$	$S_0-S_2$ to Output									
$t_{TLH}$	Transition Time	0.30	1.90	0.30	1.80	0.30	2.10	ns		(Note 10)
$t_{THL}$	20% to 80%, 80% to 20%									

**Note 7:** F100K 300 Series cold temperature testing is performed by temperature soaking (to guarantee junction temperature equals  $-55^\circ C$ ), then testing immediately after power-up. This provides "cold start" specs which can be considered a worst case condition at cold temperatures.

**Note 8:** Screen tested 100% on each device at  $+25^\circ C$  temperature only, Subgroup A9.

**Note 9:** Sample tested (Method 5005, Table I) on each manufactured lot at  $+25^\circ C$ , Subgroup A9, and at  $+125^\circ C$  and  $-55^\circ C$ , temperatures, Subgroups A10 and A11.

**Note 10:** Not tested at  $+25^\circ C$ ,  $+125^\circ C$ , and  $-55^\circ C$  temperature (design characterization data).

## Test Circuitry

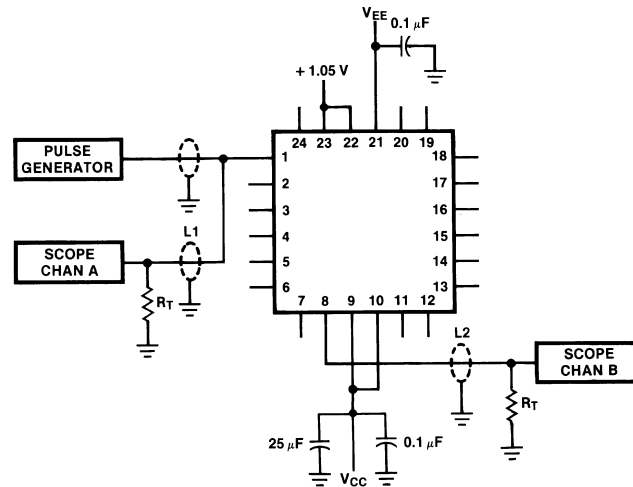

DS100310-6

### Notes:

$V_{CC}, V_{CCA} = +2V$ ,  $V_{EE} = -2.5V$

L1 and L2 = equal length 50Ω impedance lines

$R_T = 50\Omega$  terminator internal to scope

Decoupling 0.1 μF from GND to  $V_{CC}$  and  $V_{EE}$

All unused outputs are loaded with 50Ω to GND

$C_L$  = Fixture and stray capacitance  $\leq 3$  pF

Pin numbers shown are for flatpak; for DIP see logic symbol

FIGURE 1. AC Test Circuit

## Switching Waveforms

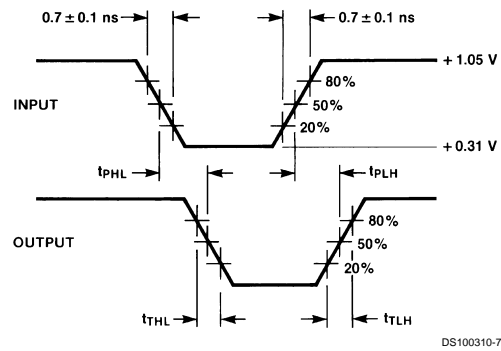
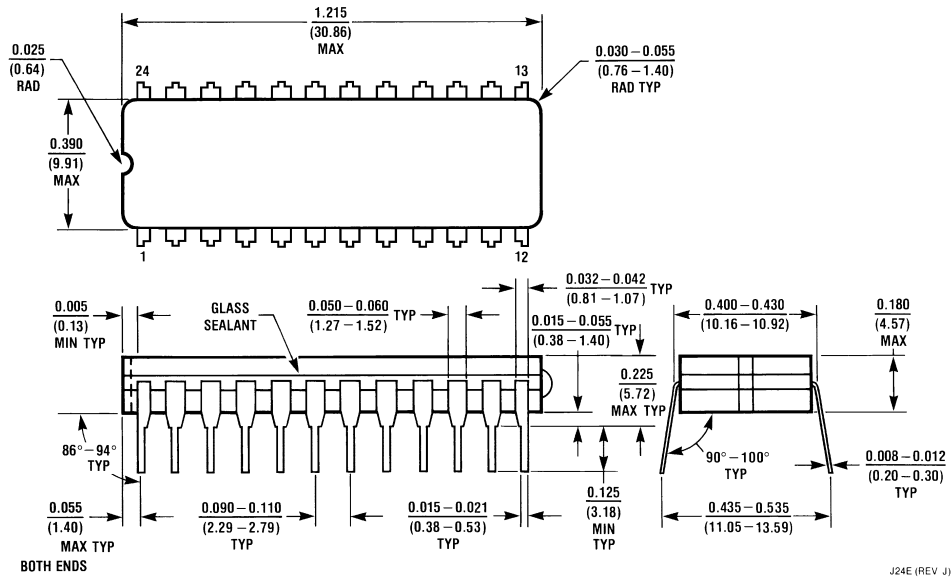

FIGURE 2. Propagation Delay and Transition Times

**Physical Dimensions** inches (millimeters) unless otherwise noted



J24E (REV J)

**24-Pin Ceramic Dual-In-Line Package (D)**  
NS Package Number J24E

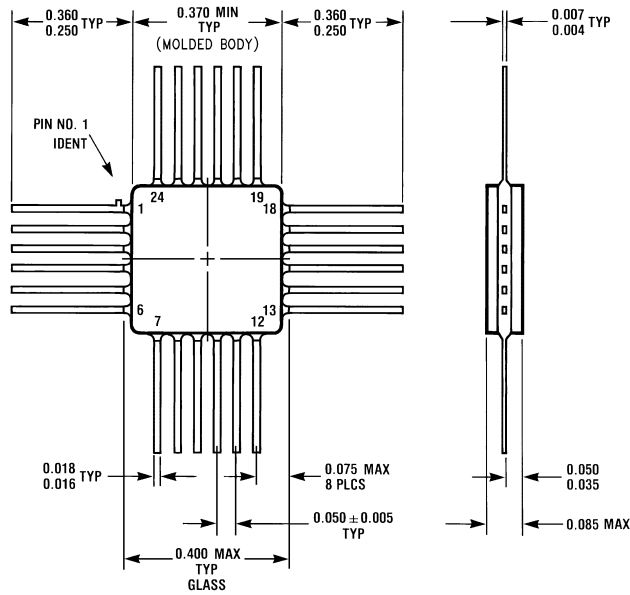

W24B (REV D)

**24-Pin Quad Cerpak (F)**  
NS Package Number W24B

**LIFE SUPPORT POLICY**

NATIONAL'S PRODUCTS ARE NOT AUTHORIZED FOR USE AS CRITICAL COMPONENTS IN LIFE SUPPORT DEVICES OR SYSTEMS WITHOUT THE EXPRESS WRITTEN APPROVAL OF THE PRESIDENT OF NATIONAL SEMICONDUCTOR CORPORATION. As used herein:

1. Life support devices or systems are devices or systems which, (a) are intended for surgical implant into the body, or (b) support or sustain life, and whose failure to perform when properly used in accordance with instructions for use provided in the labeling, can be reasonably expected to result in a significant injury to the user.
2. A critical component in any component of a life support device or system whose failure to perform can be reasonably expected to cause the failure of the life support device or system, or to affect its safety or effectiveness.



**National Semiconductor Corporation**  
Americas  
Tel: 1-800-272-9959  
Fax: 1-800-737-7018  
Email: support@nsc.com

[www.national.com](http://www.national.com)

**National Semiconductor Europe**  
Fax: +49 (0) 1 80-530 85 86  
Email: europe.support@nsc.com  
Deutsch Tel: +49 (0) 1 80-530 85 85  
English Tel: +49 (0) 1 80-532 78 32  
Français Tel: +49 (0) 1 80-532 93 58  
Italiano Tel: +49 (0) 1 80-534 16 80

**National Semiconductor Asia Pacific Customer Response Group**  
Tel: 65-2544466  
Fax: 65-2504466  
Email: sea.support@nsc.com

**National Semiconductor Japan Ltd.**  
Tel: 81-3-5620-6175  
Fax: 81-3-5620-6179