

**30A, 600V, TO-247**

# THYRISTOR Type : 30KRC60

Construction : Center Gate Planner Type

Application : AC Power Control For General Use

## Absolute Maximum Ratings

Rating	Symbol	Voltage Ratings			Unit
		30KRC60			
Repetitive Peak off-state Voltage	$V_{DRM}$	600			V
Non-repetitive Peak off-state Voltage	$V_{DSM}$	700			V
Repetitive Peak Reverse Voltage	$V_{RRM}$	600			V
Non-repetitive Peak Reverse Voltage	$V_{RSM}$	700			V

Rating	Symbol	Conditions	Max. Rated Value	Unit
Average On-State Current	$I_{O(AV)}$	180° Conduction, $T_c=80^\circ\text{C}$	30	A
RMS On-State Current	$I_{T(RMS)}$		47	A
Surge On-State Current	$I_{ISM}$	50Hz Half Sine Wave, 1Pulse, Non-Repetitive	600	A
ISquared t	$I^2t$	2 to 10ms	1800	A <sup>2</sup> s
Peak Gate Power	$P_{GM}$		5	W
Average Gate Power	$P_{G(AV)}$		1	W
Peak Forward Gate Current	$I_{GM}$		2	A
Peak Forward Gate Voltage	$V_{GM}$		10	V
Peak Reverse Gate Voltage	$V_{RCM}$		5	V
Operating Junction Temperature Range	$T_{jw}$		-40 to +125	°C
Storage Temperature Range	$T_{stg}$		-40 to +150	°C
Mounting Force		Recommended Value	0.5	N•m

## Electrical Characteristics

Characteristics	Symbol	Conditions	Min.	Typ.	Max.	Unit
Peak Off-State Current	$I_{DM}$	$V_{DM}=V_{DRM}$	$T_j=25^\circ\text{C}$		0.5	mA
			$T_j=125^\circ\text{C}$		10	
Peak Reverse Current	$I_{RM}$	$V_{RM}=V_{RRM}$	$T_j=25^\circ\text{C}$		0.5	mA
			$T_j=125^\circ\text{C}$		10	
Peak On-State Voltage	$V_{TM}$	$T_j=25^\circ\text{C}, I_{TM}=90\text{A}$			1.5	V
Gate Trigger Current	$I_{GT}$	$V_D=6\text{V}, I_T=1\text{A}$	$T_j=-40^\circ\text{C}$		220	mA
			$T_j=25^\circ\text{C}$		100	
			$T_j=125^\circ\text{C}$		50	
Gate Trigger Voltage	$V_{GT}$	$V_D=6\text{V}, I_T=1\text{A}$	$T_j=-40^\circ\text{C}$		4.0	V
			$T_j=25^\circ\text{C}$		2.5	
			$T_j=125^\circ\text{C}$		2.0	
Gate Non-Trigger Current	$V_{GD}$	$T_j=125^\circ\text{C}, V_D=2/3 \bullet V_{DRM}$	0.25			V
Turn-On Time	$t_g$	$T_j=125^\circ\text{C}, V_D=2/3 \bullet V_{DRM}$		6		μs
Delay Time	$t_d$			2		μs
Rise Time	$t_r$			4		μs
Latching Current	$I_L$	$T_j=25^\circ\text{C}$		100		mA
Holding Current	$I_H$	$T_j=25^\circ\text{C}$		50		mA
Thermal Resistance	$R_{th(j-c)}$	Junction to Case			1.0	°C/W

30KRC60 OUTLINEDRAWING (UNIT:mm)

weight:5.55gr

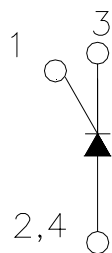
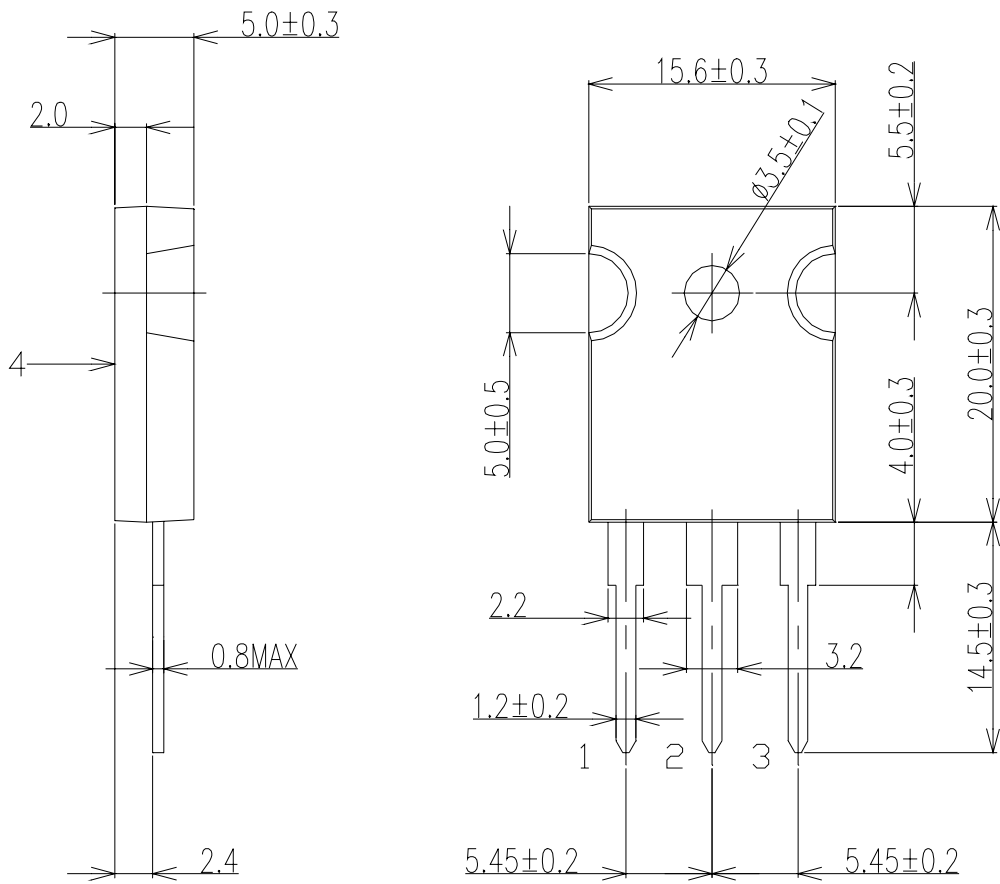

1:Gate  
2,4: Anode  
3:Cathode

オン電圧特性

ON-STATE CURRENT VS. VOLTAGE

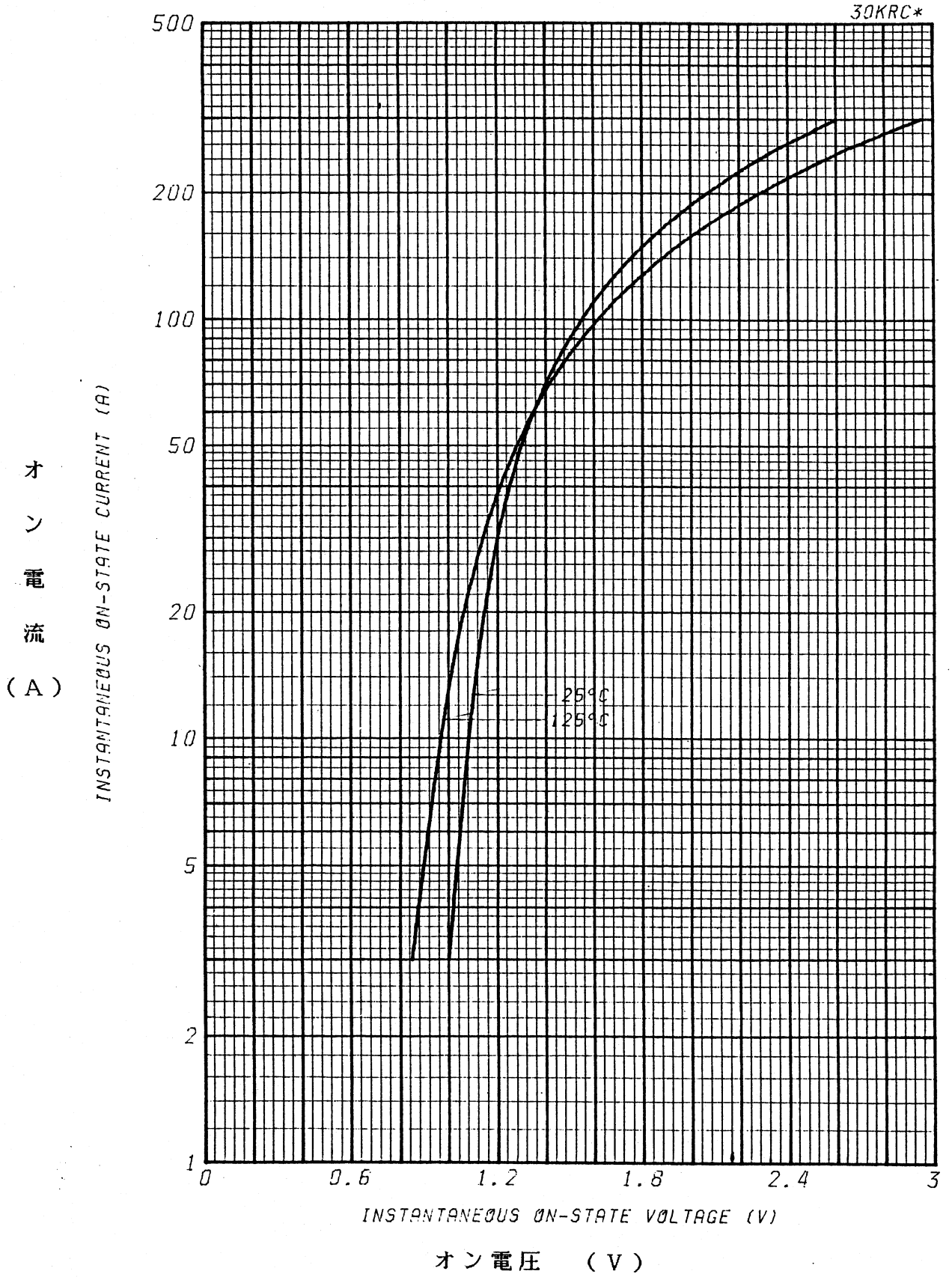

平均オン電力損失特性  
(正弦波 50 Hz)

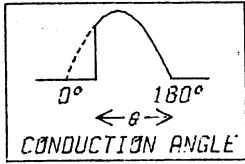

**AVERAGE ON-STATE POWER DISSIPATION**

for SINUSOIDAL CURRENT WAVEFORM

30KRC\*

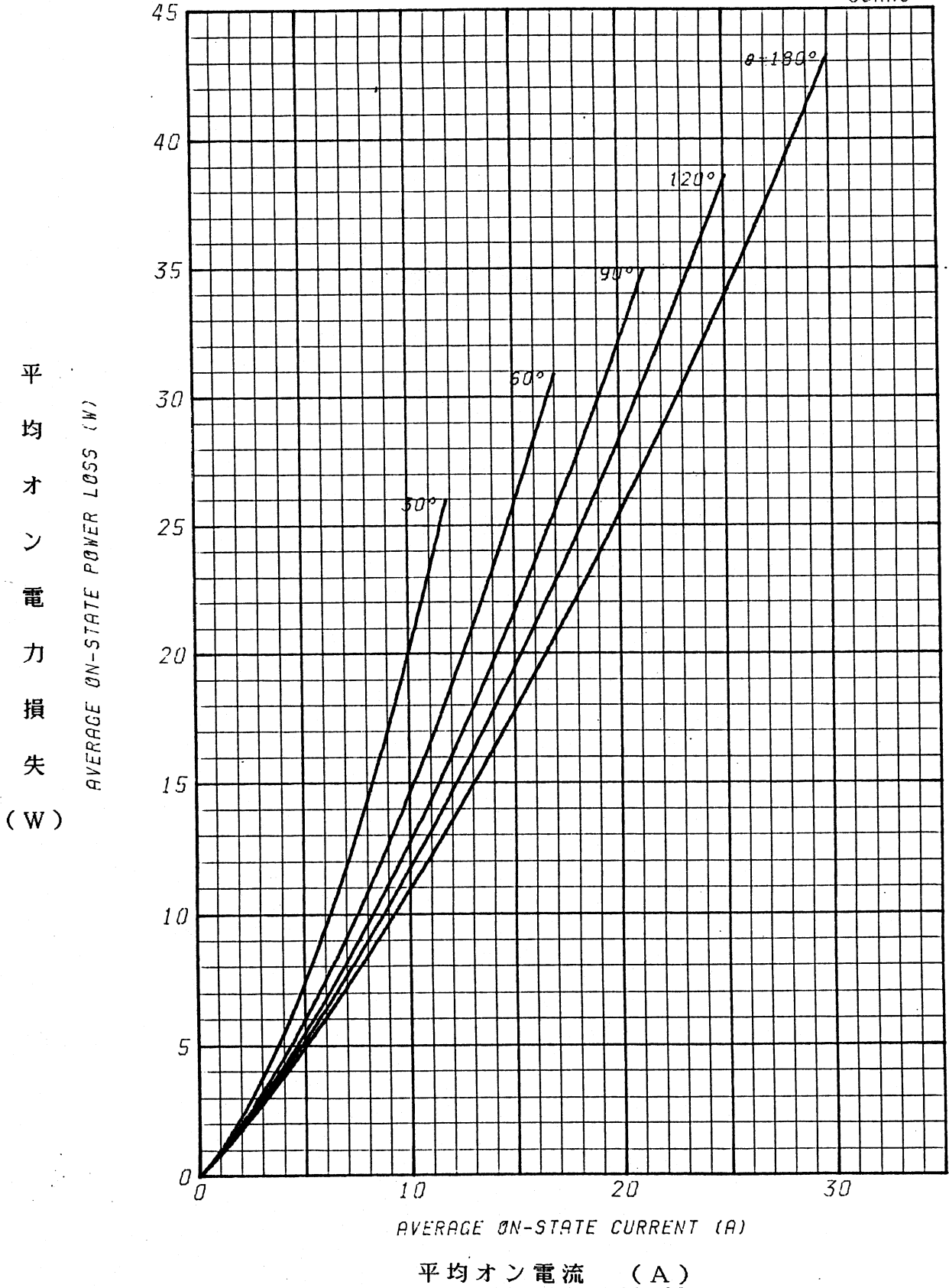

平均オン電力損失特性  
(方形波 50 Hz)

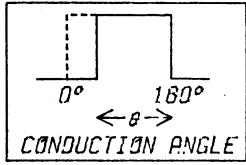

**AVERAGE ON-STATE POWER DISSIPATION**  
for RECTANGULAR CURRENT WAVEFORM

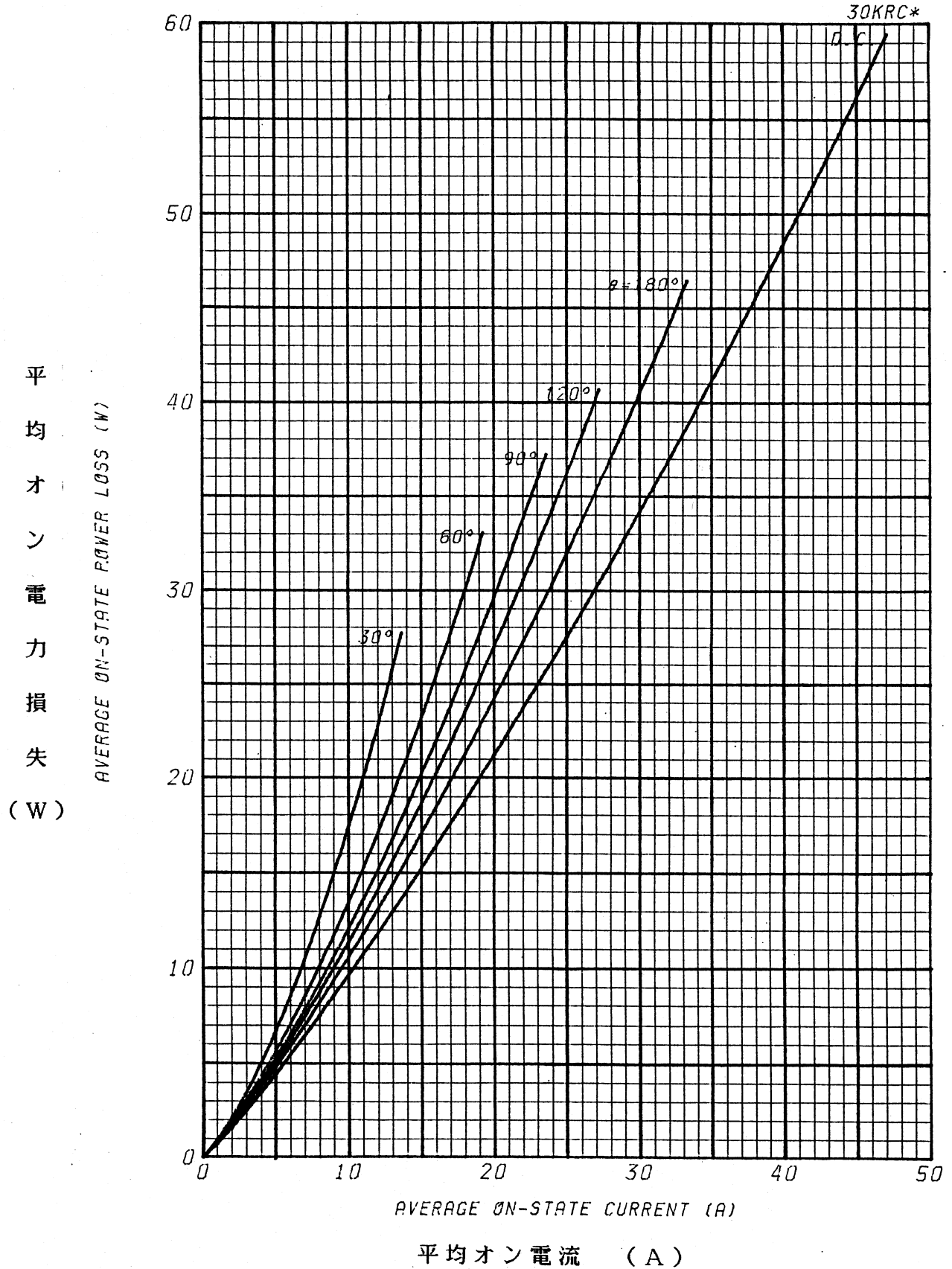

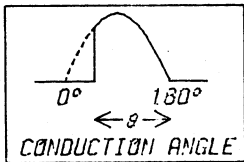

平均オン電流 - ケース温度定格  
(正弦波 50 Hz)

**AVERAGE ON-STATE CURRENT VS. CASE TEMPERATURE**

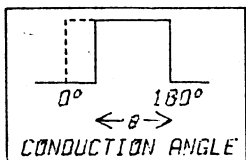
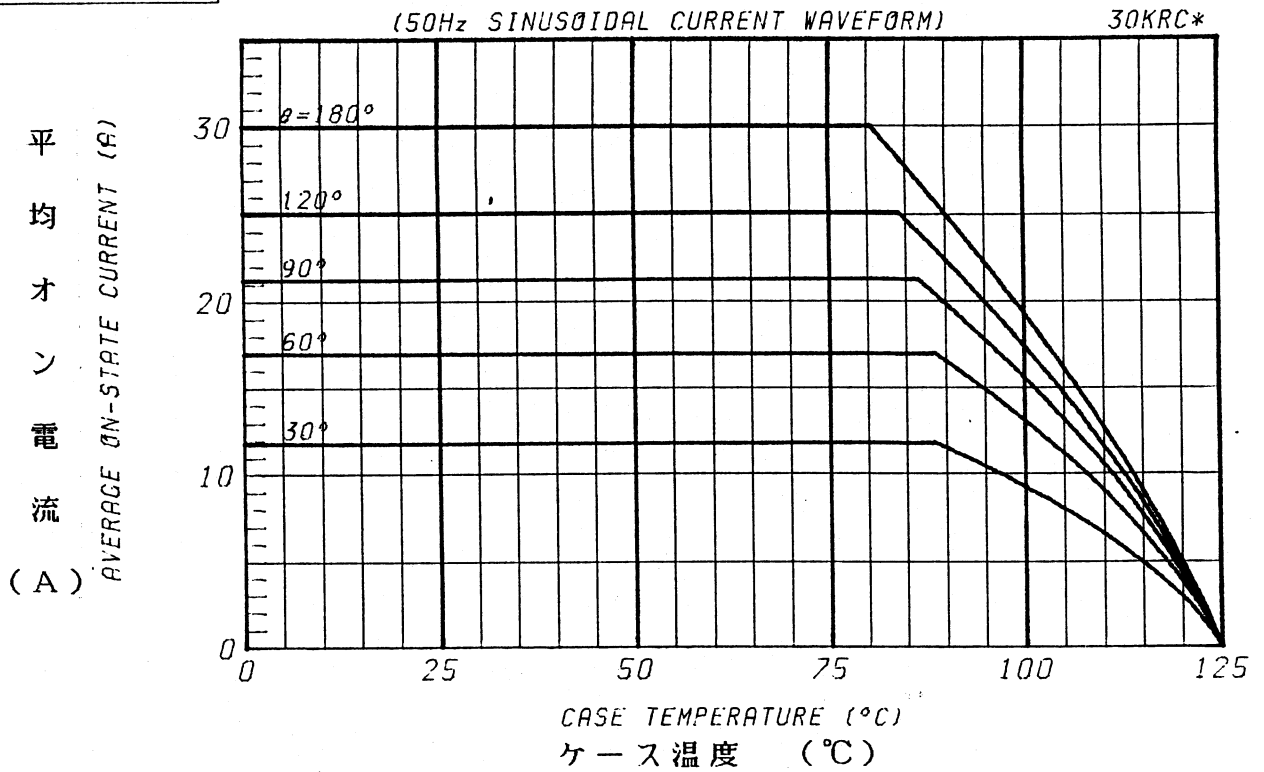

平均オン電流 - ケース温度定格  
(方形波 50 Hz)

**AVERAGE ON-STATE CURRENT VS. CASE TEMPERATURE**

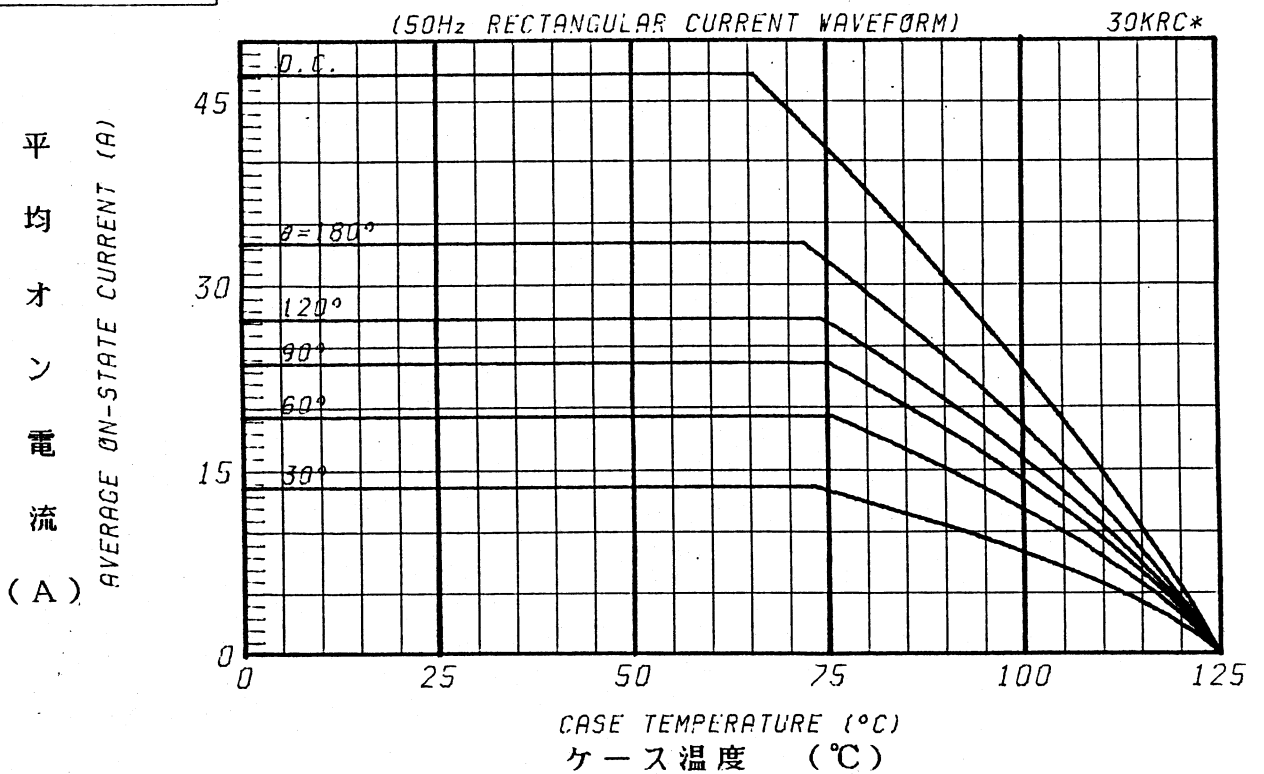

ゲート定格とゲート特性  
GATE RATINGS & CHARACTERISTICS

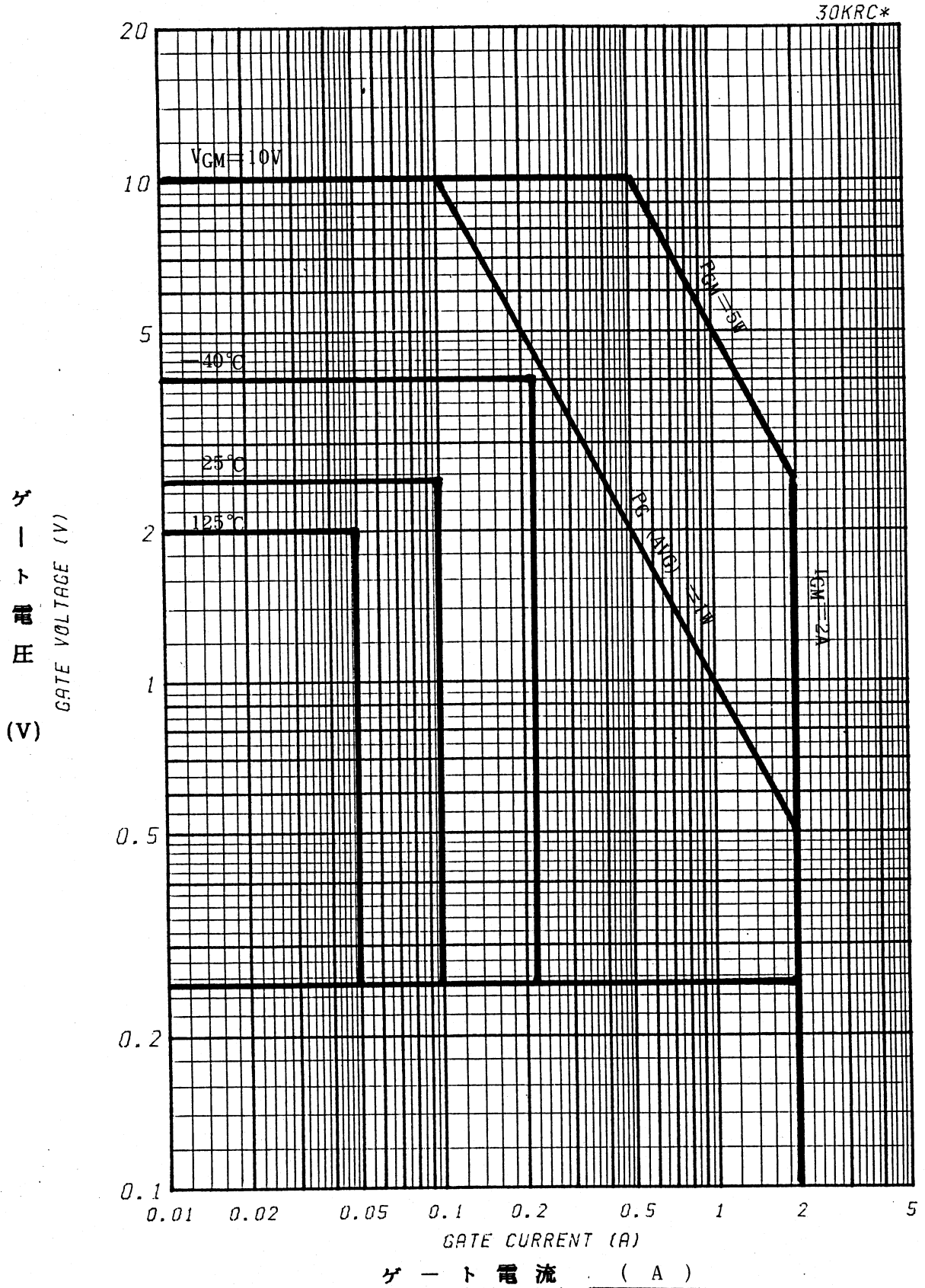

サージオン電流定格

SURGE CURRENT RATINGS

30KRC\*

サー  
ジ  
オ  
ン  
電  
流  
  
(A)

SURGE ON-STATE CURRENT (A)

