

# FRD Type: 20NFA60

## FEATURES

- \* Ultra – Fast Recovery
- \* Low Forward Voltage Drop
- \* Low Power Loss, High Efficiency
- \* High Surge Capability
- \* 400 Volts and 600 Volts Types Available

## OUTLINE DRAWING

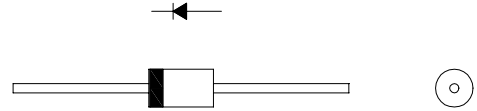

## Maximum Ratings

Apporox Net Weight:1.19g

Rating	Symbol	20NFA60		Unit
Repetitive Peak Reverse Voltage	$V_{RRM}$	600		V
Average Rectified Output Current	$I_O$	2.0	$T_l=104^{\circ}C$ $T_l$ : Lead Temperature	50HzHalf Sine Wave Resistive Load
		1.15	$T_a=25^{\circ}C$ *1	
RMS Forward Current	$I_{F(RMS)}$	3.14		A
Surge Forward Current	$I_{FSM}$	50	50Hz Half Sine Wave,1cycle, Non-repetitive	A
Operating JunctionTemperature Range	$T_{jw}$	- 40 to + 150		$^{\circ}C$
Storage Temperature Range	$T_{stg}$	- 40 to + 150		$^{\circ}C$

## Electrical/Thermal • Characteristics

Characteristics	Symbol	Conditions	Min.	Typ.	Max.	Unit
Peak Reverse Current	$I_{RM}$	$T_j= 25^{\circ}C, V_{RM}= V_{RRM}$	-	-	10	$\mu A$
Peak Forward Voltage	$V_{FM}$	$T_j= 25^{\circ}C, I_{FM}= 2A$	-	-	1.58	V
Reverse Recovery Time	$t_{rr}$	$T_a= 25^{\circ}C, I_{FM}=2A -di/dt=50A/\mu s$	-	-	35	ns
Thermal Resistance	$R_{th(j-l)}$	Junction to Lead	-	-	15	$^{\circ}C/W$
	$R_{th(j-a)}$	Junction to Ambient			90	

\*1: Without Fin or P.C. Board

20NFA\_ OUTLINE DRAWING (Dimensions in mm)

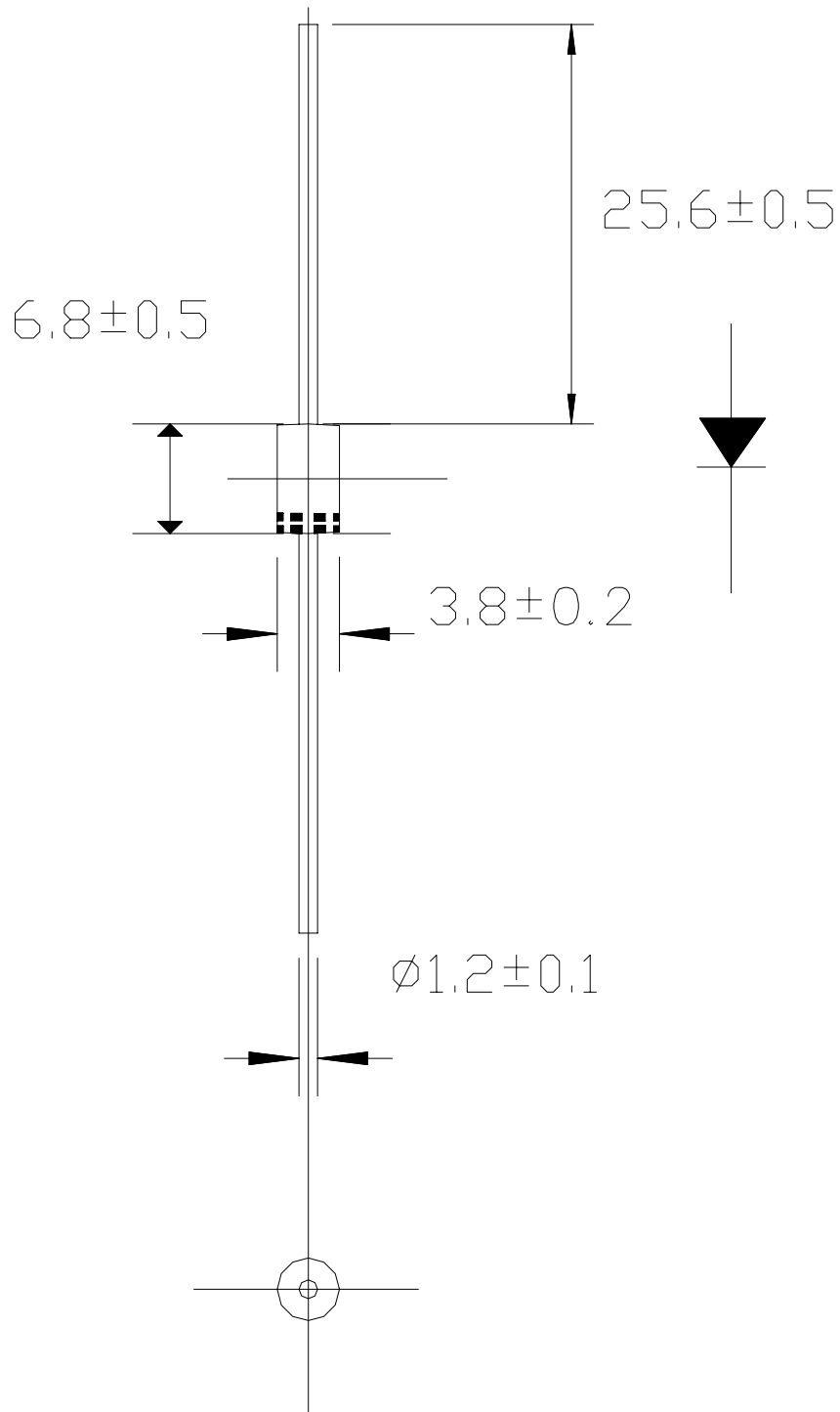

FORWARD CURRENT VS. VOLTAGE

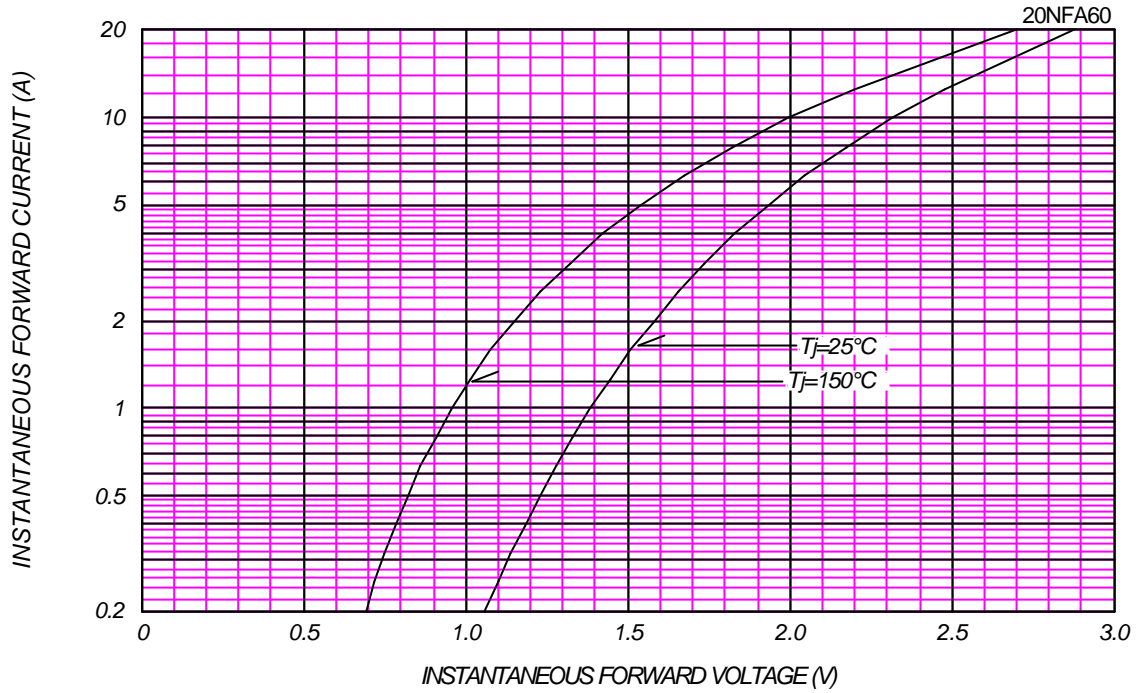

AVERAGE FORWARD POWER DISSIPATION

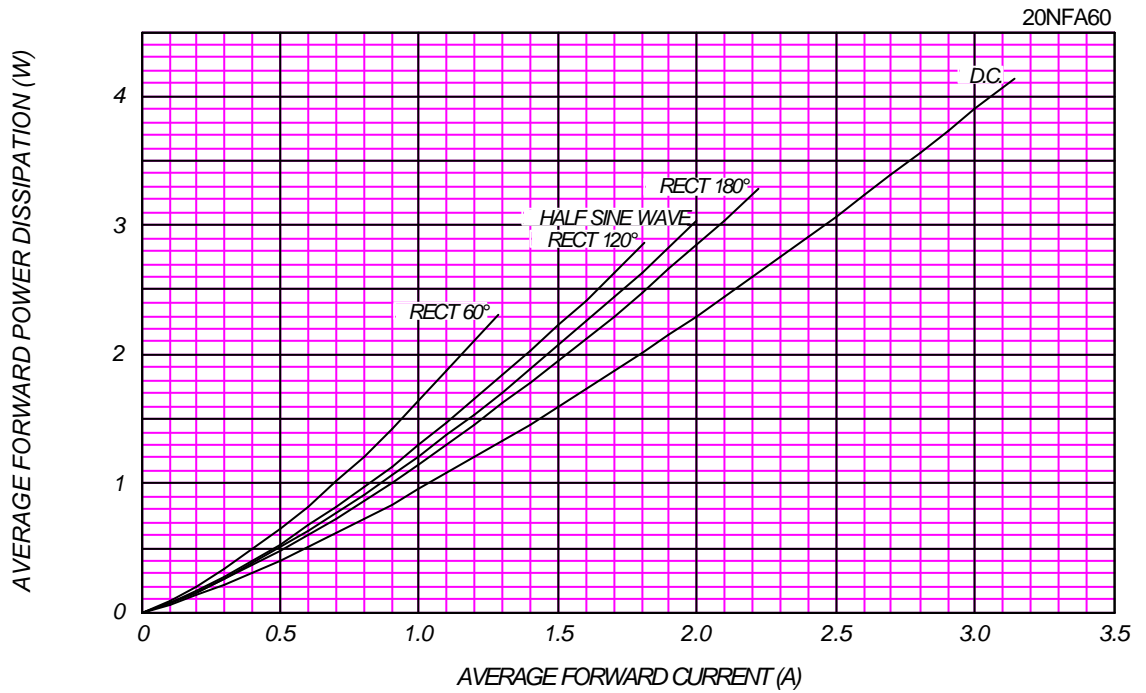



### AVERAGE FORWARD CURRENT VS. AMBIENT TEMPERATURE

Without Fin or P.C.Board

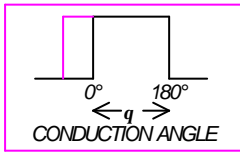
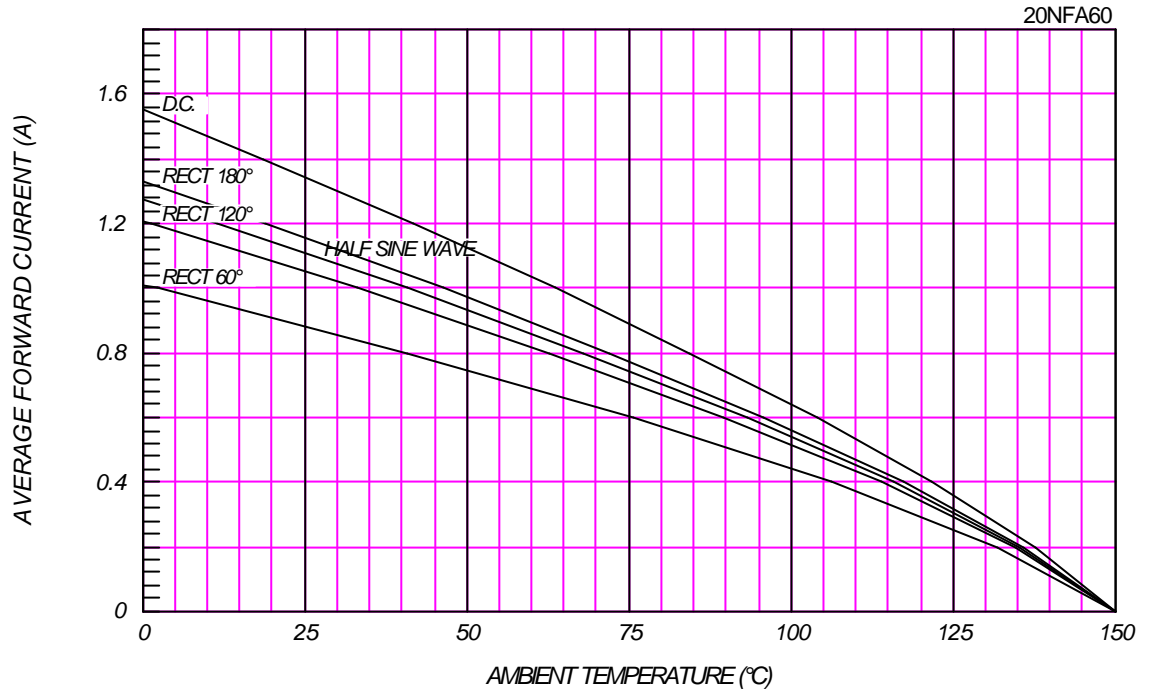

### AVERAGE FORWARD CURRENT VS. LEAD TEMPERATURE

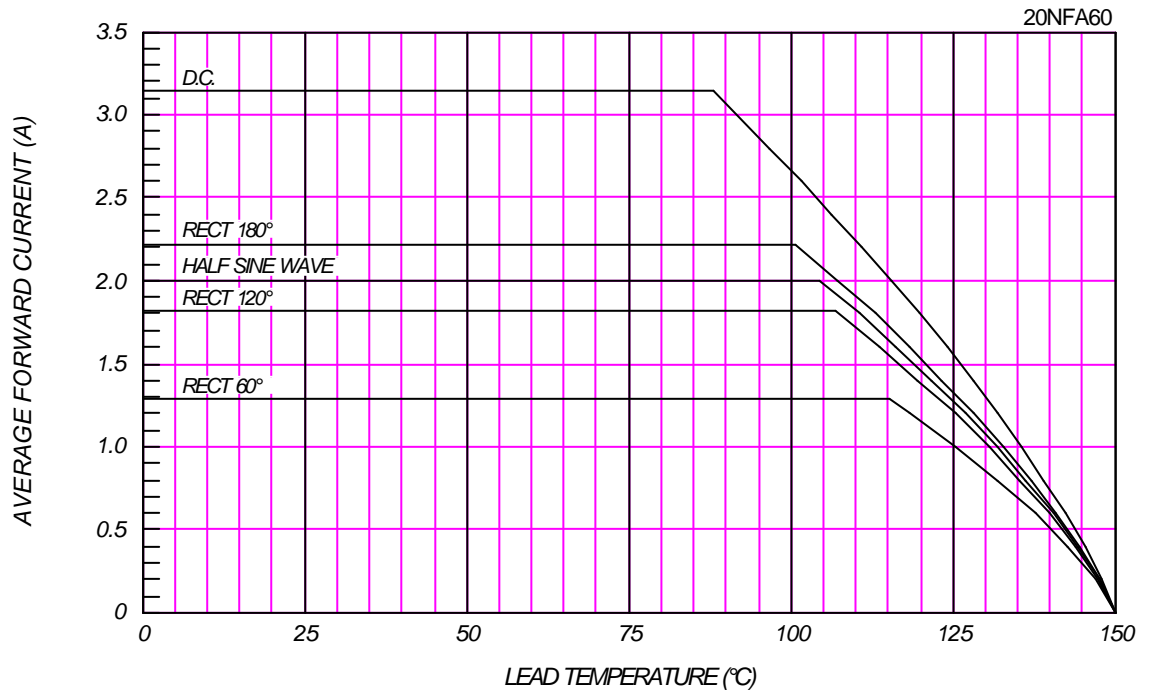

# SURGE CURRENT RATINGS

f=50Hz,Half Sine Wave,Non-Repetitive,No Load

20NFA60

