

**AUTOMOTIVE RELAYS
EP2F/EP1F SERIES****HIGH HEAT RESISTIVITY****DESCRIPTION**

The NEC EP2F / EP1F series are PC-board mount type automotive relays suitable for various motor controls and other applications that require a high level of quality and performance.

The operate temperature range for EP2F / EP1F series is -40°C through $+125^{\circ}\text{C}$.

By this high heat resistivity, the contact carrying current of EP2F / EP1F series at 25°C increases 1.3 or 1.4 times compared with that of EP2 / EP1 series.

FEATURES

- Operating ambient temperature up to $+125^{\circ}\text{C}$ (EP2 / EP1 : $+85^{\circ}\text{C}$)
- Suitable for motor and solenoid reversible control
- High performance and productivity by unique structure
- Flux tight housing

APPLICATIONS

- Power window control
- Power sunroof
- Wiper system

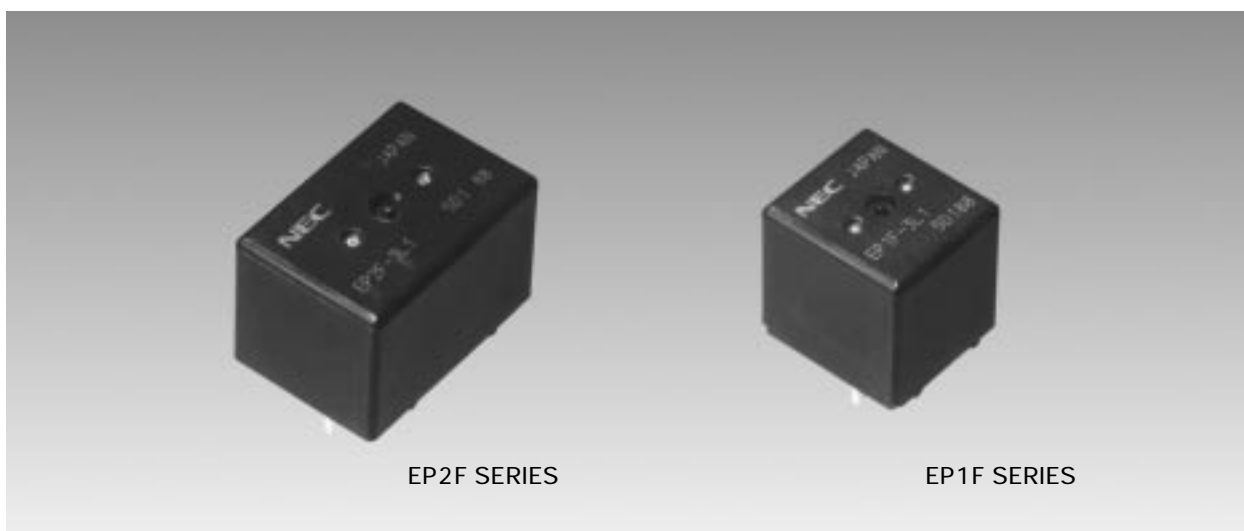

SCHMATIC (BOTTOM VIEW)

EP2F SERIES

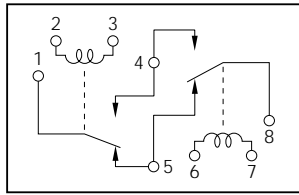

[Unit A] [Unit B]
[H Bridge Type]

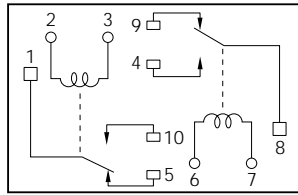

[Unit A] [Unit B]
[Separate Type]

EP1F SERIES

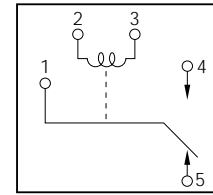

DIMENSIONS mm (inch)

EP2F SERIES

H Bridge Type

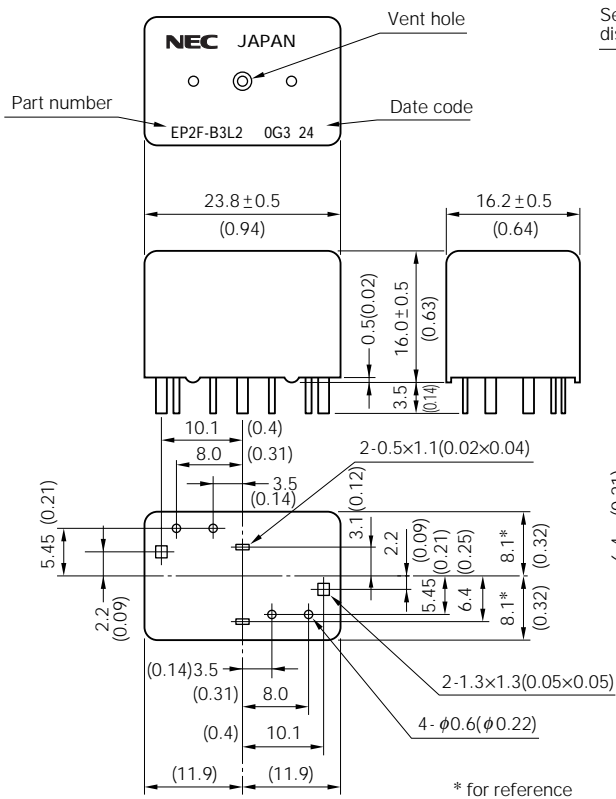

Separate Type

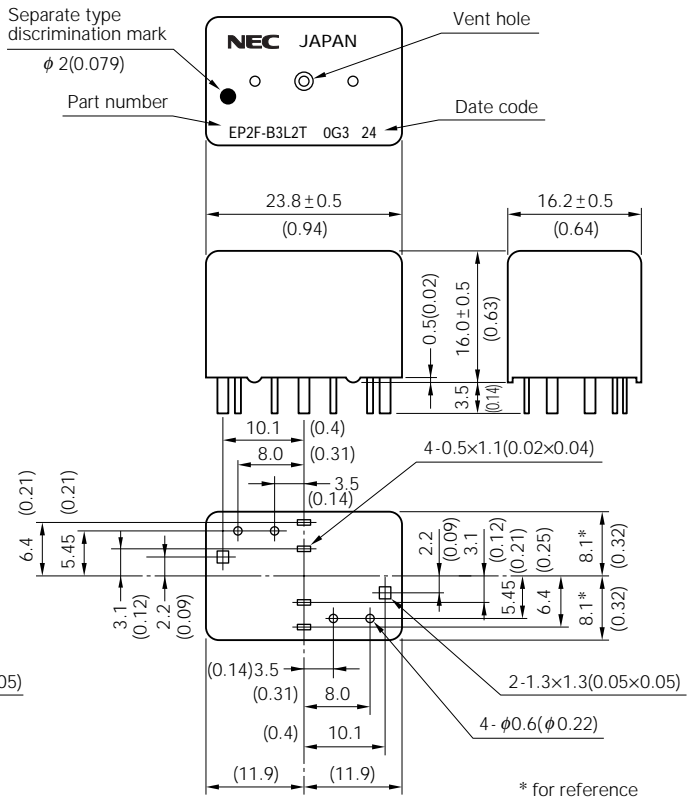

EP1F SERIES

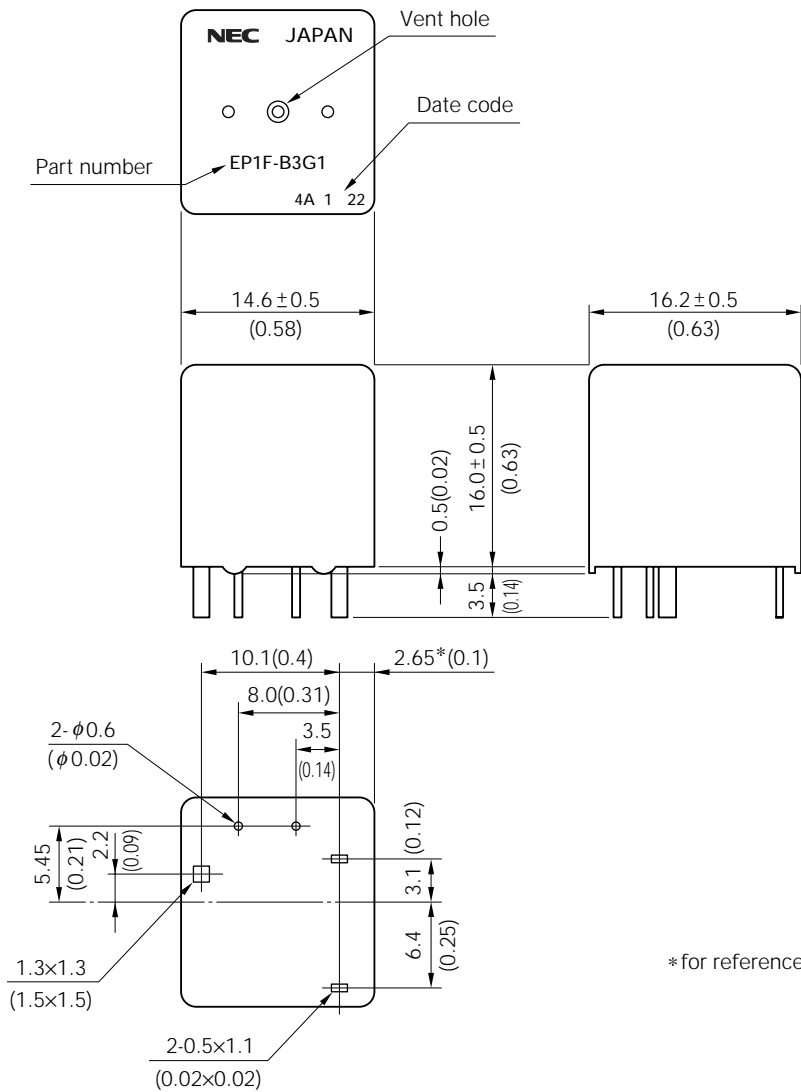

PCB PAD LAYOUT mm (inch) (BOTTOM VIEW)

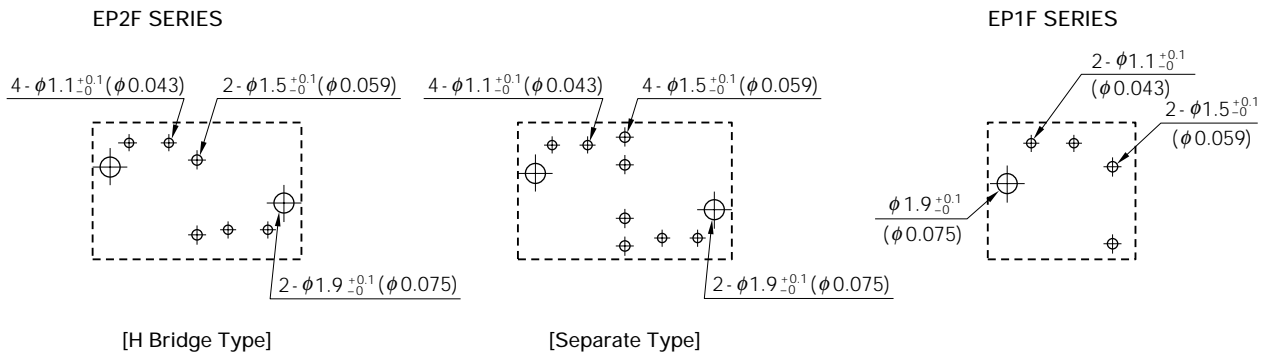

SPECIFICATIONS

at 25 °C (77 °F)

Items		EP2F	EP1F
Contact Form		1 form C×2 (H bridge type and separate type)	1 form C
Contact Material		Silver oxide complex alloy	
Contact Resistance		50 mΩ max. (measured at 7 A) initial	
Contact Switching Voltage		16 Vdc max.	
Contact Switching Current		25 A max.	
Contact Carrying Current		35 A (2 minutes max. 12 Vdc at 25°C) 30 A (2 minutes max. 12 Vdc at 85°C) 25 A (2 minutes max. 12 Vdc at 125°C)	40 A (2 minutes max. 12 Vdc at 25°C) 35 A (2 minutes max. 12 Vdc at 85°C) 30 A (2 minutes max. 12 Vdc at 125°C)
Operate Time		Approx. 5 ms (at 12 Vdc excluding bounce) initial	
Release Time		Approx. 2 ms (at 12 Vdc excluding bounce) initial	
Normal Operate Power		0.64 W (at 12 Vdc)	
Insulation Resistance		100 MΩ min. (at 500 Vdc) initial	
Breakdown Voltage		500 Vdc min. (for 1 minute) initial	
Shock Resistance		98 m / s ² [Approx. 10 G] min. (misoperating)	
Vibration Resistance		10 to 300 Hz, 43 m / s ² [Approx. 4.4 G] min. (misoperating)	
Ambient Temperature		-40 °C to +125 °C (-40 °F to +257 °F)	
Coil Temperature Rise		50 °C / W (without contact carrying current)	
Life Expectancy	Mechanical	1×10 ⁶ operations	
	Electrical	Contact G	1×10 ⁵ operations (at 14 Vdc, Motor Load 25 A / 7 A) at 25 °C 1×10 ⁵ operations (at 14 Vdc, Motor Load 18 A / 5 A) at 125 °C
		Contact L or N	1×10 ⁵ operations (at 14 Vdc, Motor Load 20 A / 3 A) at 25 °C 1×10 ⁵ operations (at 14 Vdc, Motor Load 12 A / 2 A) at 125 °C
Weight		Approx. 15 gr	Approx. 8 gr

COIL RATING

EP2F SERIES

at 25 °C (77 °F)

	Part Number		Nominal Voltage (Vdc)	Coil Resistance (Ω ±10 %)	Must Operate Voltage (Vdc max.)	Must Release Voltage (Vdc min.)	Nominal Operate Power (W)
	H Bridge Type	Separate Type					
Contact G	EP2F-B3G1	EP2F-B3G1T	12	225	605	0.9	0.64
	EP2F-B3G2	EP2F-B3G2T	12	225	7.0	0.9	0.64
	EP2F-B3G3	EP2F-B3G3T	12	225	7.5	0.9	0.64
Contact L or N	EP2F-B3L1	EP2F-B3L1T	12	225	6.5	0.9	0.64
	EP2F-B3L2	EP2F-B3L2T	12	225	7.0	0.9	0.64
	EP2F-B3L3	EP2F-B3L3T	12	225	7.5	0.9	0.64

EP1F SERIES

	Part Number	Nominal Voltage (Vdc)	Coil Resistance (Ω ±10 %)	Must Operate Voltage (Vdc max.)	Must Release Voltage (Vdc min.)	Nominal Operate Power (W)
Contact G	EP1F-B3G1	12	225	6.5	0.9	0.64
	EP1F-B3G2	12	225	7.0	0.9	0.64
	EP1F-B3G3	12	225	7.5	0.9	0.64
Contact L or N	EP1F-B3L1	12	225	6.5	0.9	0.64
	EP1F-B3L2	12	225	7.0	0.9	0.64
	EP1F-B3L3	12	225	7.5	0.9	0.64

NUMBERING SYSTEM

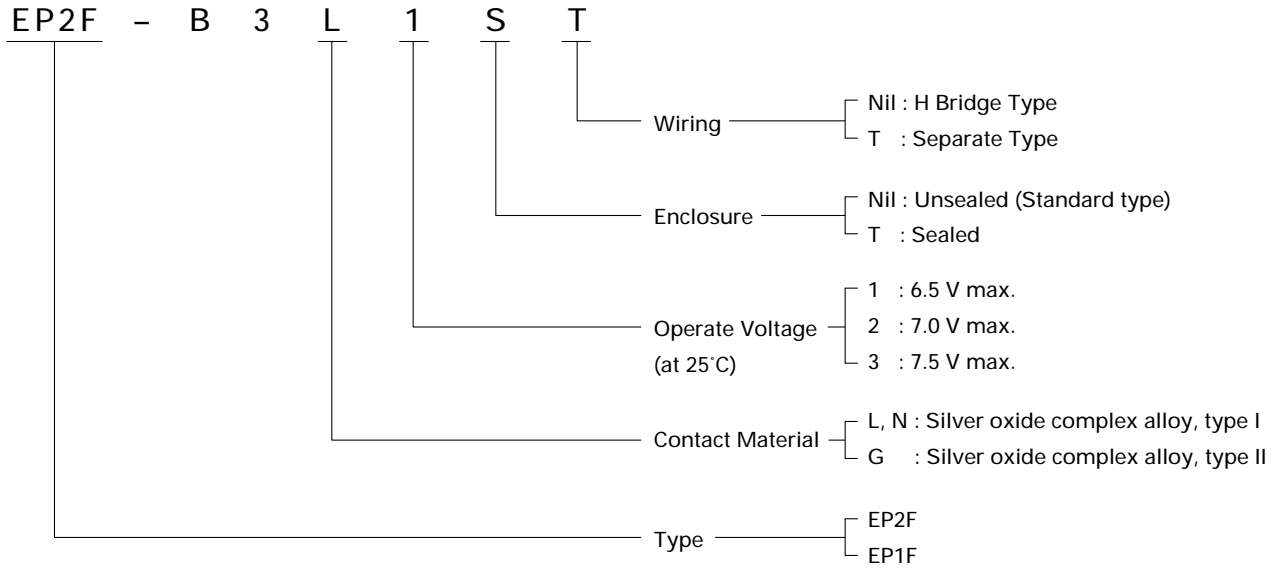

TYPICAL APPLICATION (H Bridge Type)

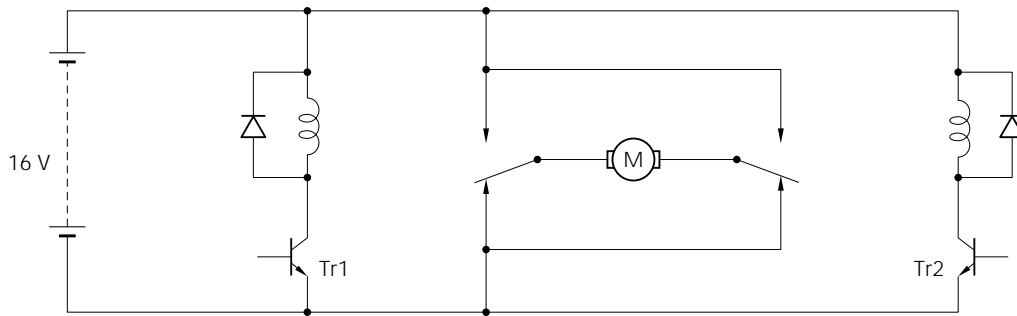

MOTOR	Tr1	Tr2
STOP	off	off
FORWARD	on	off
REVERSE	off	on

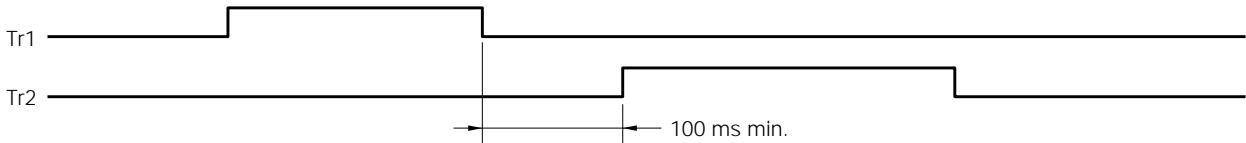

It is necessary to take more than 100 msec intervals for on / off timing between driving Tr1 and Tr2. If the interval is less than 100 msec, an excessive current happen to flow to the relay contacts.

TECHNICAL DATA

Coil Temperature (EP2F-B3L1)

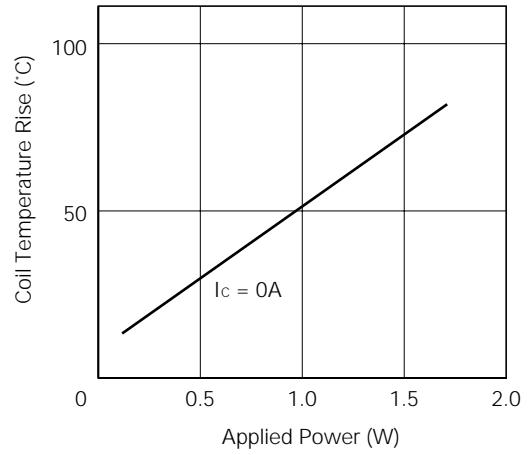
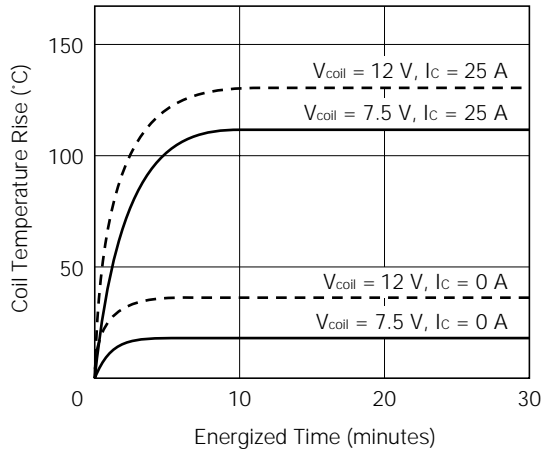

Operate Time (EP2F-B3L1)

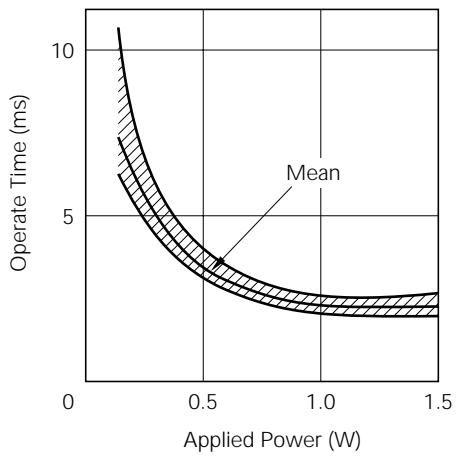

Release time (EP2F-B3L1)

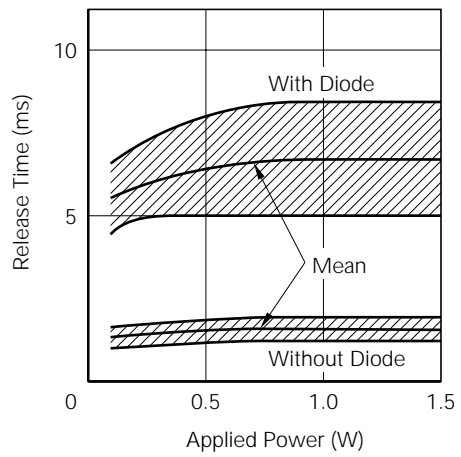

No part of this document may be copied in any form or by any means without the prior written consent of NEC Corporation.

NEC Corporation does not assume any liability for infringement of patents, copyrights or other intellectual property rights of third parties by or arising from use of a device described herein or any other liability arising from use of such device. No license, either express, implied or otherwise, is granted under any patents, copyrights or other intellectual property rights of NEC Corporation or of others.