

The RF Line
746–960 MHz RF LDMOS Wideband
Integrated Power Amplifier

The MHVIC915R2 wideband integrated circuit is designed for CDMA and GSM/GSM EDGE applications. It uses Motorola's newest high voltage (26 to 28 Volts) LDMOS IC technology and integrates a multi-stage structure. Its wideband On-Chip integral matching circuitry makes it usable from 746 to 960 MHz. The linearity performances cover all modulations for cellular applications: GSM, GSM EDGE, TDMA, and CDMA. The device is packaged in a PFP-16 flat pack package that provides excellent thermal performance through a solderable backside contact.

- Typical CDMA Performance: 869–894 MHz, 27 Volts, $I_{DQ1} = 80$ mA, $I_{DQ2} = 120$ mA, 1-Carrier N-CDMA, IS-95 CDMA 9-Channel Forward

Driver Application

- Output Power — 23 dBm
- Power Gain — 31 dB
- Adjacent Channel Power Ratio —
 - 60 dBc @ 750 kHz in a 30 kHz BW
 - 66 dBc @ 1.98 MHz in a 30 kHz BW

Output Application

- Output Power — 34 dBm
- PAE = 21%
- Adjacent Channel Power Ratio —
 - 50 dBc @ 750 kHz in a 30 kHz BW

- Typical GSM Performance: 921–960 MHz, 26 Volts
- Output Power — 15 W P1dB
- Power Gain — 30 dB @ P1dB
- Drain Efficiency = 56% @ P1dB
- On-Chip Matching (50 Ohm Input, >9 Ohm Output)
- On-Chip Current Mirror g_m Sensing FET for Self Bias Application
- Integrated Temperature Compensation Capability
- Usable for SCPA and MCPA Architecture
- Integrated ESD Protection
- Available in Tape and Reel. R2 Suffix = 1,500 Units per 16 mm, 13 inch Reel.

MHVIC915R2

CDMA, GSM/GSM EDGE
746–960 MHz, 15 W, 27 V
RF LDMOS WIDEBAND
INTEGRATED AMPLIFIER

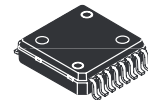

CASE 978-03
PFP-16
PLASTIC

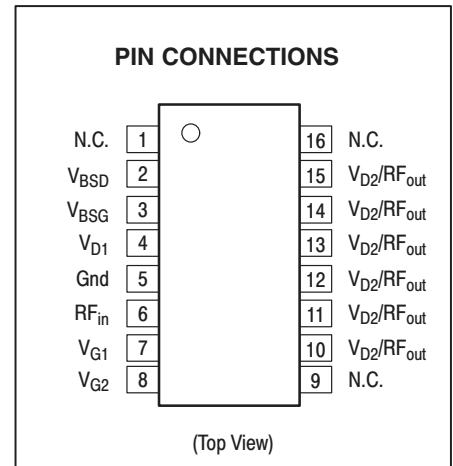
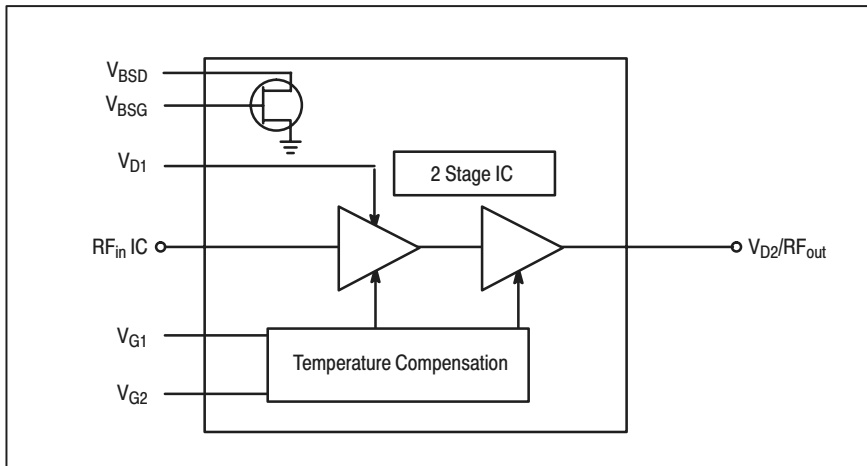

Freescale Semiconductor, Inc.

MAXIMUM RATINGS

Rating	Symbol	Value	Unit
Drain–Source Voltage	V_{DSS}	65	Vdc
Gate–Source Voltage	V_{GS}	–0.5, +15	Vdc
Storage Temperature Range	T_{stg}	–65 to +150	°C
Operating Junction Temperature	T_J	150	°C

THERMAL CHARACTERISTICS

Characteristic	Symbol	Max	Unit
Thermal Resistance, Junction to Case	$R_{\theta JC}$		°C/W
Driver Application ($P_{out} = 0.2$ W CW)	Stage 1, 27 Vdc, $I_{DQ} = 80$ mA Stage 2, 27 Vdc, $I_{DQ} = 120$ mA	5.07	
Output Application ($P_{out} = 2.5$ W CW)	Stage 1, 27 Vdc, $I_{DQ} = 80$ mA Stage 2, 27 Vdc, $I_{DQ} = 120$ mA	3.73	
GSM Application ($P_{out} = 15$ W CW)	Stage 1, 26 Vdc, $I_{DQ} = 50$ mA Stage 2, 26 Vdc, $I_{DQ} = 140$ mA	3.41	

ESD PROTECTION CHARACTERISTICS

Test Conditions	Class
Human Body Model	1 (Minimum)
Machine Model	M1 (Minimum)
Charge Device Model	C4 (Minimum)

MOISTURE SENSITIVITY LEVEL

Test Methodology	Rating
Per JESD 22–A113	3

ELECTRICAL CHARACTERISTICS ($T_C = 25^\circ\text{C}$ unless otherwise noted)

Characteristic	Symbol	Min	Typ	Max	Unit
----------------	--------	-----	-----	-----	------

CDMA FUNCTIONAL TESTS (In Motorola CDMA Test Fixture, 50 ohm system) $V_{DS} = 27$ V, $I_{DQ1} = 80$ mA, $I_{DQ2} = 120$ mA, 880 MHz, 1–Carrier N–CDMA, IS–95 CDMA 9–Channel Forward

Common–Source Amplifier Power Gain ($P_{out} = 23$ dBm)	G_{ps}	29	31	—	dB
Power Added Efficiency ($P_{out} = 34$ dBm)	η	—	21	—	%
Input Return Loss ($P_{out} = 23$ dBm)	IRL	—	–12	–9	dB
Adjacent Channel Power Ratio ($P_{out} = 23$ dBm) @ 750 kHz offset in 30 kHz BW	ACPR	—	–60	–55	dBc
Adjacent Channel Power Ratio ($P_{out} = 34$ dBm) @ 750 kHz offset in 30 kHz BW	ACPR	—	–50	—	dBc
Gain Flatness @ $P_{out} = 23$ dBm (865 MHz to 895 MHz)	G_F	—	0.2	0.4	dB
Bias Sense FET Drain Current $V_{BSD} = 27$ V $V_{BIAS\ BSG} = V_{BIAS2\ Q2}$ @ $I_{DQ2} = 120$ mA	I_{BSD}	0.8	1.2	1.6	mA

(continued)

Freescale Semiconductor, Inc.

ELECTRICAL CHARACTERISTICS – continued (T_C = 25°C unless otherwise noted)

Characteristic	Symbol	Min	Typ	Max	Unit
----------------	--------	-----	-----	-----	------

PERFORMANCE TESTS (In Motorola Test Fixture, 50 ohm system) V_{DS} = 27 V, I_{DQ1} = 80 mA, I_{DQ2} = 120 mA, 865–895 MHz

Rating	Symbol	Min	Typ	Max	Unit
Quiescent Current Accuracy over Temperature (–10 to 85°C) at Nominal Value	ΔI _{qt}	—	±5	—	%
Gain Flatness @ P _{out} = 23 dBm (800 MHz to 960 MHz)	G _F	—	0.20	—	dB
Deviation from Linear Phase @ P _{out} = 23 dBm	∅	—	±0.2	—	°
Group Delay @ P _{out} = 23 dBm	Delay	—	2.2	—	ns
Insertion Phase Window @ P _{out} = 23 dBm (part to part)	Δ∅	—	±10	—	°

GSM FUNCTIONAL TESTS (In Motorola GSM Test Fixture, 50 ohm system) V_{DS} = 26 V, I_{DQ1} = 50 mA, I_{DQ2} = 140 mA, 921–960 MHz, CW

Rating	Symbol	Min	Typ	Max	Unit
Output Power at 1dB Compression Point	P1dB	—	15	—	Watts
Common–Source Amplifier Power Gain @ P1dB	Gain	—	30	—	dB
Drain Efficiency @ P1dB	η	—	56	—	%
Input return Loss @ P1dB	IRL	—	–16	—	dB
EVM @ 5 W	—	—	0.9	—	%
Third Order Intermodulation Distortion (15 W PEP, 2 Tone 100 kHz spacing)	IMD3	—	–30	—	dBc
Drain Efficiency (15 W PEP, 2 Tone 100 kHz spacing)	η	—	35	—	%

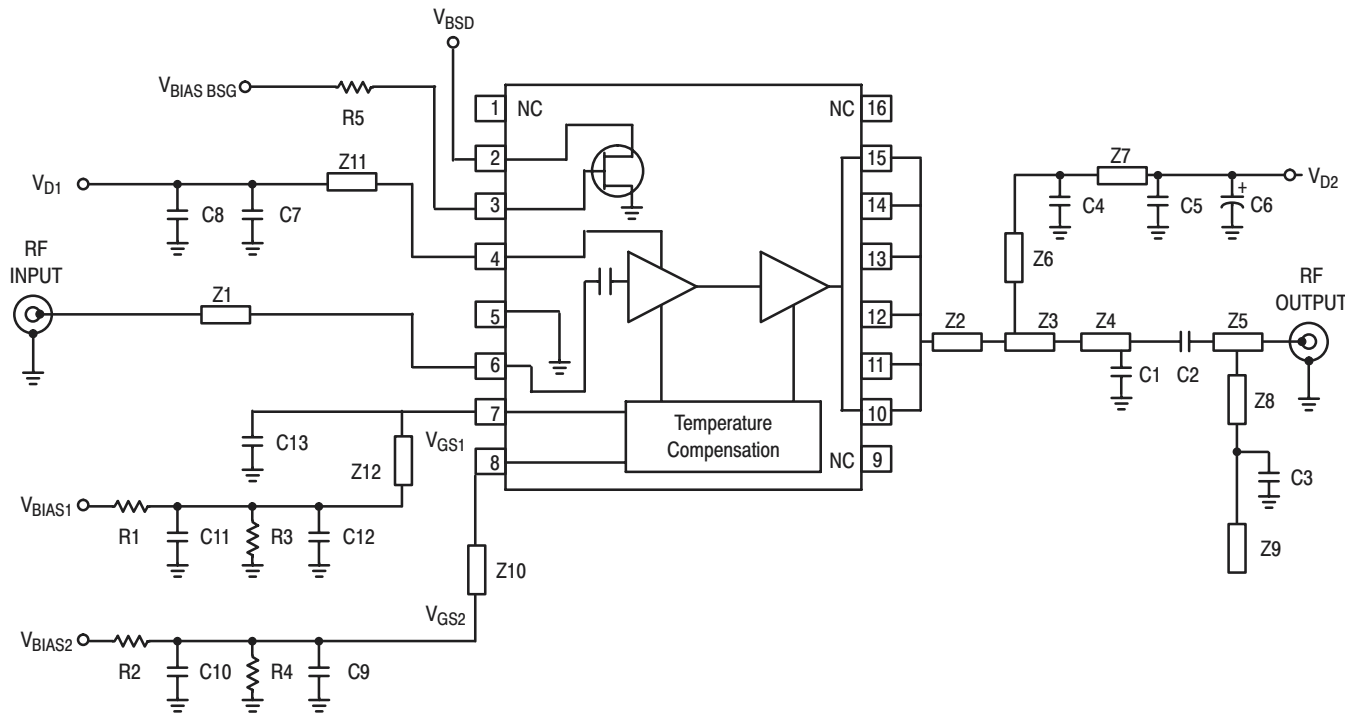

- | | | | |
|----|---|-----|--|
| Z1 | 0.0438" x 0.400" 50 Ω Microstrip | Z7 | 0.0504" x 0.480" Microstrip |
| Z2 | 0.1709" x 0.1004" Microstrip
(not including IC pad length) | Z8 | 0.0252" x 0.843" Microstrip |
| Z3 | 0.1222" x 0.1944" Microstrip | Z9 | 0.0252" x 0.167" Microstrip |
| Z4 | 0.0836" x 0.3561" Microstrip | Z10 | 0.040" x 0.850" Microstrip |
| Z5 | 0.0438" x 0.2725" Microstrip | Z11 | 0.025" x 0.400" Microstrip |
| Z6 | 0.0504" x 0.3378" Microstrip | Z12 | 0.020" x 0.710" Microstrip |
| | | PCB | Rogers 4350, 0.020", ε _r = 3.50 |

Figure 1. MHVIC915 746–960 MHz Test Circuit Schematic

Table 1. MHVIC915 746–960 MHz Test Circuit Component Designations and Values

Part	Description	Value, P/N or DWG	Manufacturer
C1, C2	4.7 pF High Q Capacitors (0603)	ATC600S4R7CW	ATC
C3, C4	47 pF NPO Capacitors (0805)	GRM40–001COG470J050BD	Murata
C5, C8, C10, C11	1 μF X7R Chip Capacitors (1214)	GRM42–2X7R105K050AL	Murata
C6	10 μF, 50 V Electrolytic Capacitor	ECEV1HA100SP	Panasonic
C7, C9, C12	0.01 μF X7R Chip Capacitors (0805)	GRM40X7R103J050BD	Murata
C13	8.2 pF NPO Chip Capacitor (0805)	GRM40–001COG8R2C050BD	Murata
R1, R2, R5	1 kΩ Chip Resistors (0603)	RM73B2AT102J	KOA Speer
R3, R4	100 kΩ Chip Resistors (0603)	RM73B2AT104J	KOA Speer

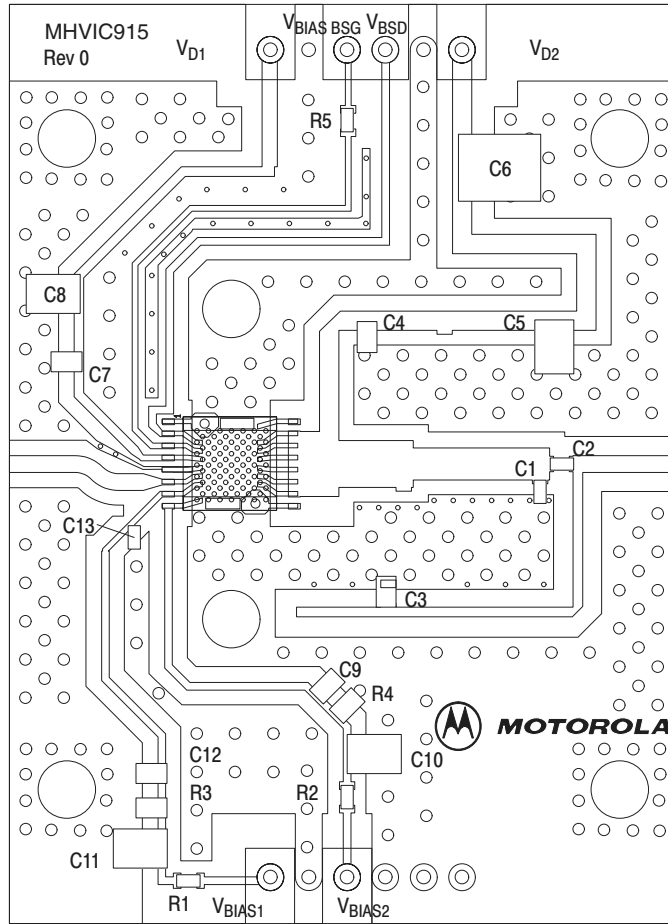

Figure 2. MHVIC915 746–960 MHz Test Circuit Component Layout

TYPICAL CHARACTERISTICS (MOTOROLA TEST FIXTURE, 50 OHM SYSTEM)

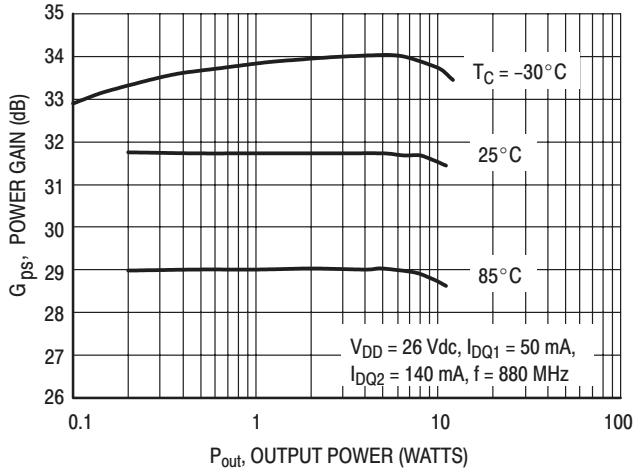

Figure 3. Power Gain versus Output Power

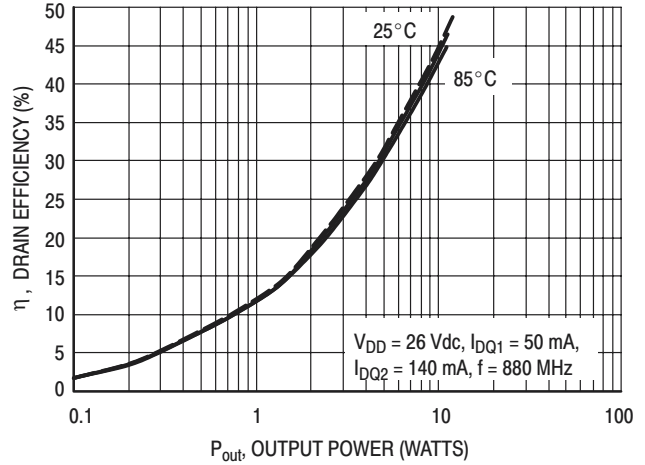

Figure 4. Drain Efficiency versus Output Power

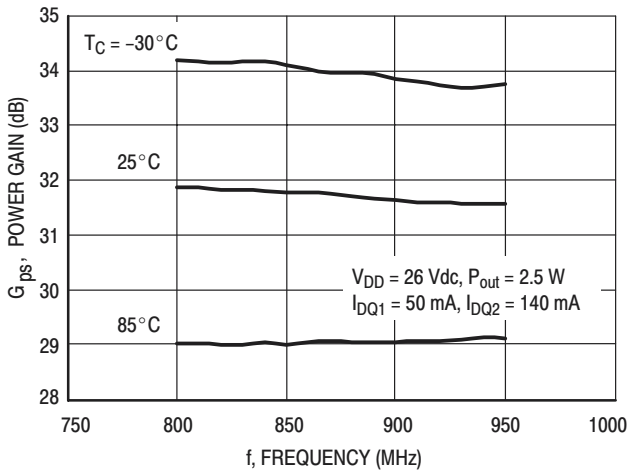

Figure 5. Power Gain versus Frequency

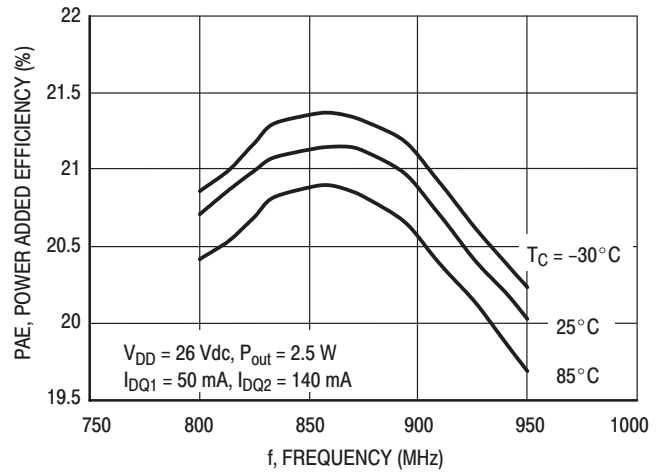

Figure 6. Power Added Efficiency versus Frequency

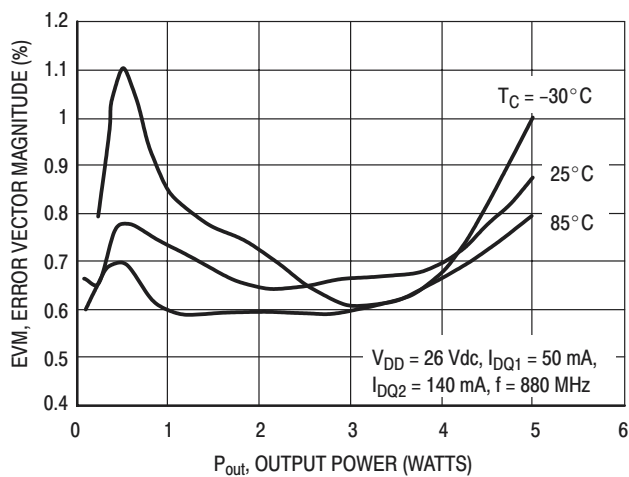

Figure 7. Error Vector Magnitude versus Output Power

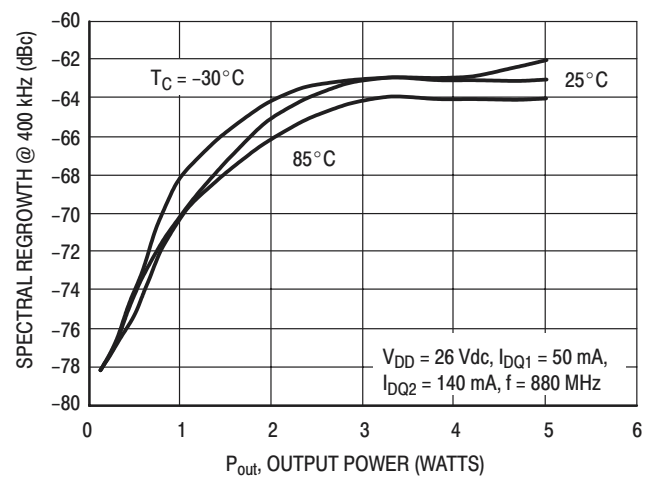

Figure 8. Spectral Regrowth @ 400 kHz versus Output Power

TYPICAL CHARACTERISTICS (MOTOROLA TEST FIXTURE, 50 OHM SYSTEM)

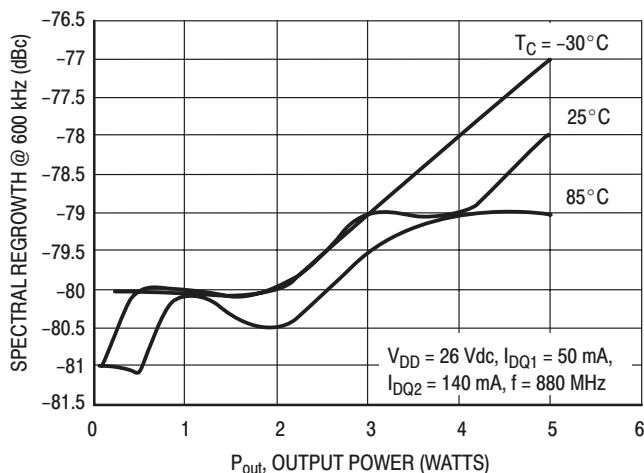

Figure 9. Spectral Regrowth @ 600 kHz versus Output Power

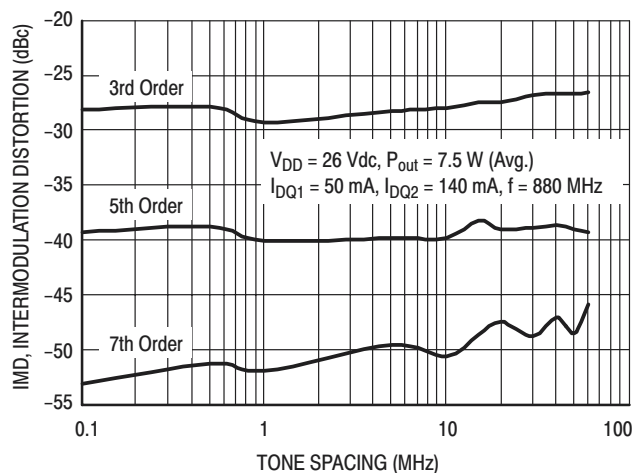

Figure 10. Two-Tone Broadband Performance

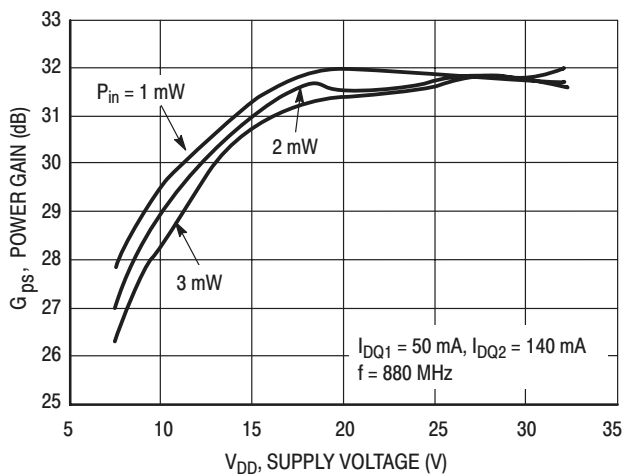

Figure 11. Power Gain versus Supply Voltage

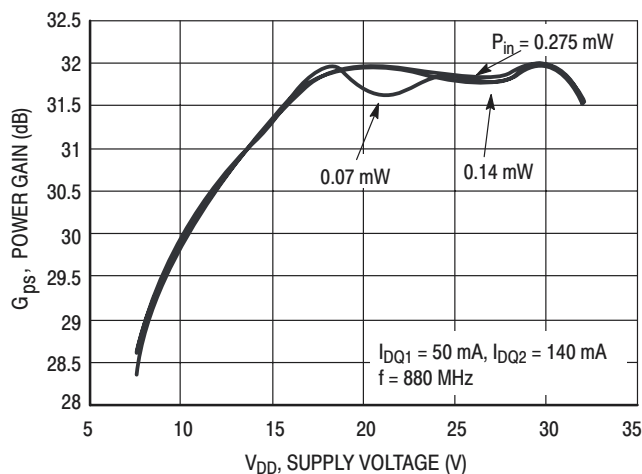

Figure 12. Power Gain versus Supply Voltage

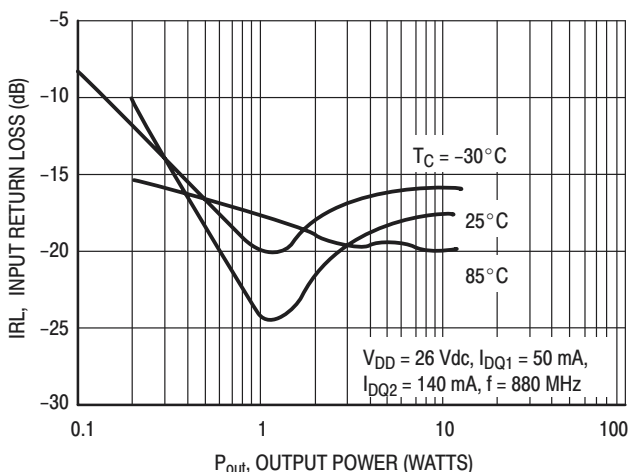

Figure 13. Input Return Loss versus Output Power

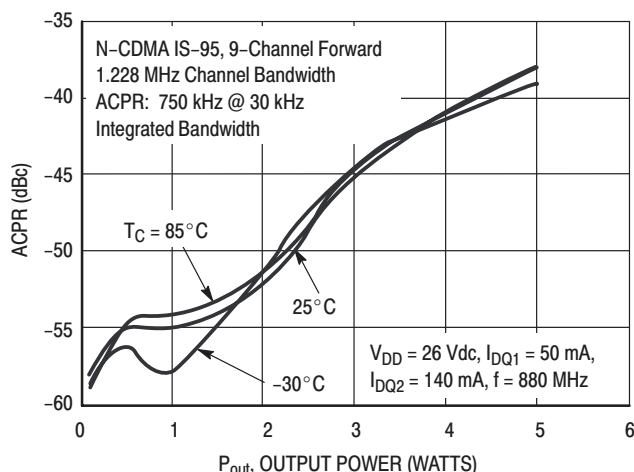
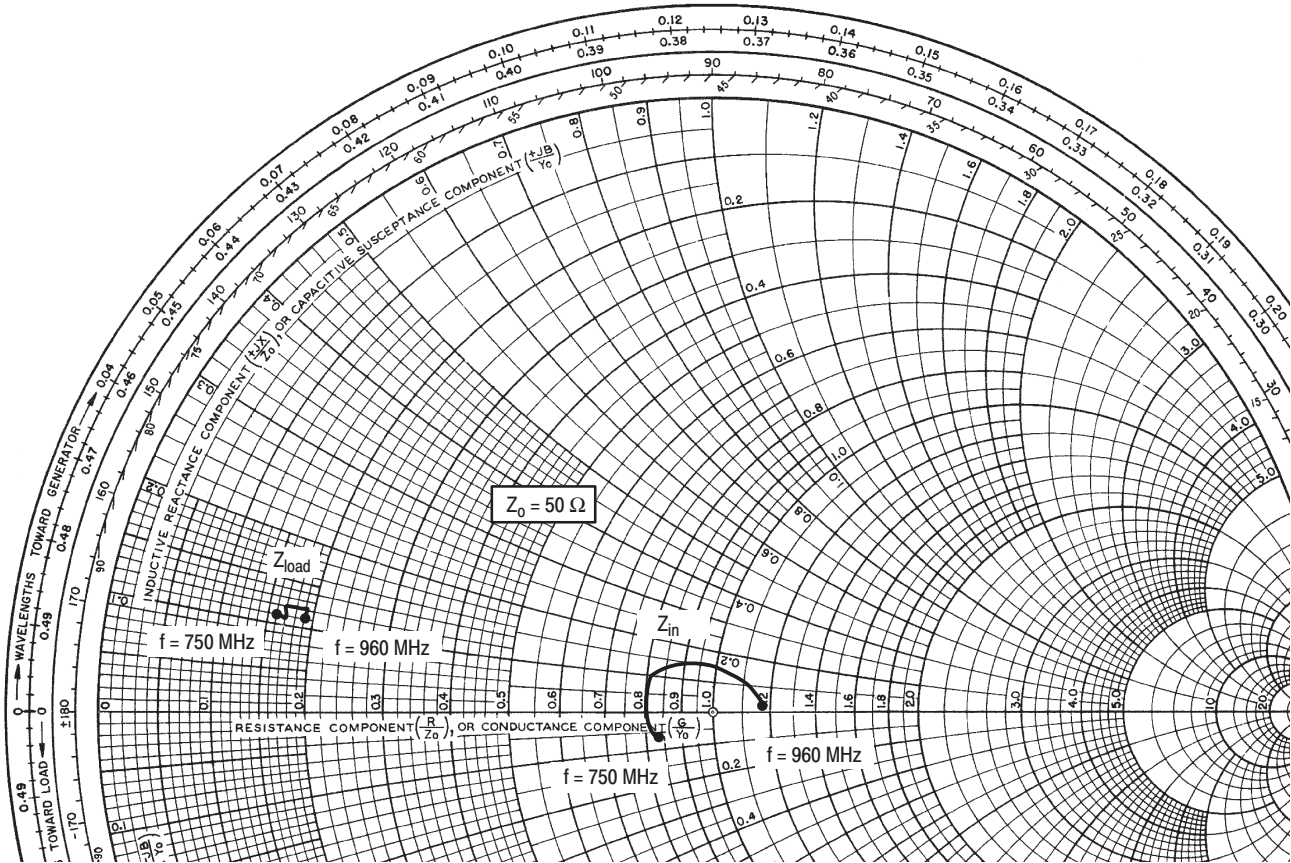

Figure 14. Adjacent Channel Power Ratio versus Output Power



$V_{DD} = 26 \text{ Vdc}$, $I_{DQ1} = 50 \text{ mA}$, $I_{DQ2} = 140 \text{ mA}$, $P_{out} = 1.25 \text{ W CW}$

f MHz	Z_{in} Ω	Z_{load} Ω
750	$42.11 - j2.79$	$8.24 + j5.33$
765	$40.86 - j1.37$	$8.31 + j5.56$
780	$40.09 + j0.06$	$8.39 + j5.82$
795	$39.77 + j1.52$	$8.50 + j5.95$
810	$39.89 + j3.01$	$8.62 + j6.02$
825	$40.49 + j4.39$	$8.82 + j6.12$
840	$41.48 + j5.70$	$8.94 + j6.19$
855	$42.89 + j6.73$	$9.12 + j6.17$
870	$43.51 + j7.03$	$9.16 + j6.12$
885	$46.81 + j7.87$	$9.33 + j6.09$
900	$49.21 + j7.74$	$9.38 + j5.95$
915	$51.79 + j7.02$	$9.50 + j5.85$
930	$54.48 + j5.65$	$9.47 + j5.73$
945	$57.05 + j3.61$	$9.54 + j5.63$
960	$59.16 + j0.75$	$9.42 + j5.45$

Z_{in} = Device input impedance as measured from RF input to ground.

Z_{load} = Test circuit impedance as measured from drain to ground.

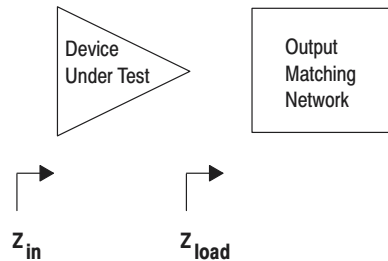

Figure 15. Series Equivalent Input and Output Impedance

NOTES

NOTES

NOTES

Freescale Semiconductor, Inc.

PACKAGE DIMENSIONS

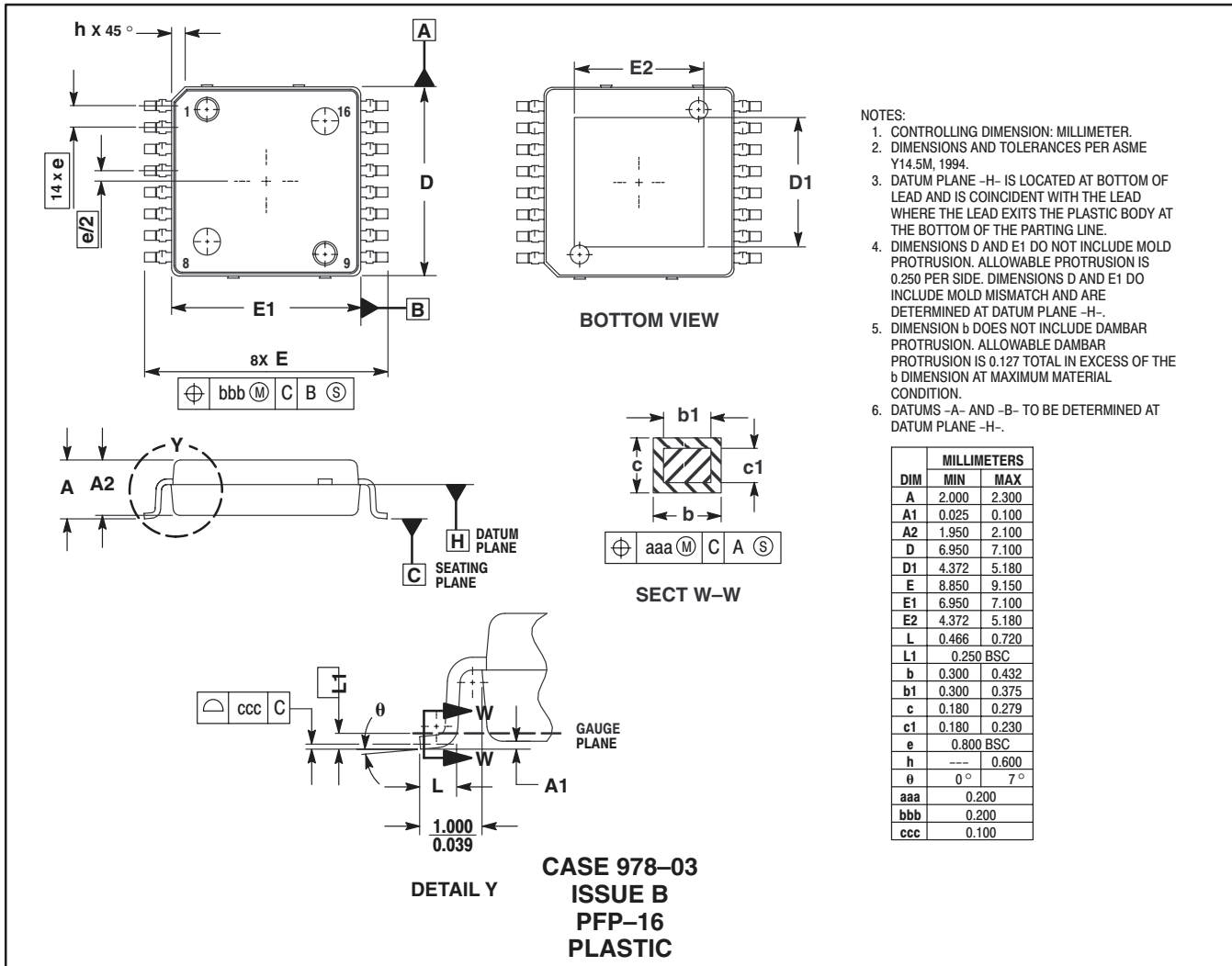

Information in this document is provided solely to enable system and software implementers to use Motorola products. There are no express or implied copyright licenses granted hereunder to design or fabricate any integrated circuits or integrated circuits based on the information in this document.

Motorola reserves the right to make changes without further notice to any products herein. Motorola makes no warranty, representation or guarantee regarding the suitability of its products for any particular purpose, nor does Motorola assume any liability arising out of the application or use of any product or circuit, and specifically disclaims any and all liability, including without limitation consequential or incidental damages. "Typical" parameters that may be provided in Motorola data sheets and/or specifications can and do vary in different applications and actual performance may vary over time. All operating parameters, including "Typicals," must be validated for each customer application by customer's technical experts. Motorola does not convey any license under its patent rights nor the rights of others. Motorola products are not designed, intended, or authorized for use as components in systems intended for surgical implant into the body, or other applications intended to support or sustain life, or for any other application in which the failure of the Motorola product could create a situation where personal injury or death may occur. Should Buyer purchase or use Motorola products for any such unintended or unauthorized application, Buyer shall indemnify and hold Motorola and its officers, employees, subsidiaries, affiliates, and distributors harmless against all claims, costs, damages, and expenses, and reasonable attorney fees arising out of, directly or indirectly, any claim of personal injury or death associated with such unintended or unauthorized use, even if such claim alleges that Motorola was negligent regarding the design or manufacture of the part.

MOTOROLA and the Stylized M Logo are registered in the US Patent and Trademark Office. All other product or service names are the property of their respective owners. Motorola, Inc. is an Equal Opportunity/Affirmative Action Employer.

© Motorola Inc. 2003

HOW TO REACH US:

USA/EUROPE/LOCATIONS NOT LISTED:
Motorola Literature Distribution
P.O. Box 5405, Denver, Colorado 80217
1-800-521-6274 or 480-768-2130

JAPAN: Motorola Japan Ltd.; SPS, Technical Information Center,
3-20-1, Minami-Azabu, Minato-ku, Tokyo 106-8573, Japan
81-3-3440-3569

ASIA/PACIFIC: Motorola Semiconductors H.K. Ltd.; Silicon Harbour Centre,
2 Dai King Street, Tai Po Industrial Estate, Tai Po, N.T., Hong Kong
852-2668334

HOME PAGE: <http://motorola.com/semiconductors>



MOTOROLA

For More Information On This Product,
Go to: www.freescale.com

MHVIC915R2/D