

# Octal D-Type Flip-Flop with 3-State Output

The MC74VHCT574A is an advanced high speed CMOS octal flip-flop with 3-state output fabricated with silicon gate CMOS technology. It achieves high speed operation similar to equivalent Bipolar Schottky TTL while maintaining CMOS low power dissipation.

This 8-bit D-type flip-flop is controlled by a clock input and an output enable input. When the output enable input is high, the eight outputs are in a high impedance state.

The VHCT inputs are compatible with TTL levels. This device can be used as a level converter for interfacing 3.3V to 5.0V, because it has full 5V CMOS level output swings.

The VHCT574A input and output (when disabled) structures provide protection when voltages between 0V and 5.5V are applied, regardless of the supply voltage. These input and output structures help prevent device destruction caused by supply voltage – input/output voltage mismatch, battery backup, hot insertion, etc.

- High Speed:  $f_{max} = 140\text{MHz}$  (Typ) at  $V_{CC} = 5\text{V}$
- Low Power Dissipation:  $I_{CC} = 4\mu\text{A}$  (Max) at  $T_A = 25^\circ\text{C}$
- TTL-Compatible Inputs:  $V_{IL} = 0.8\text{V}$ ;  $V_{IH} = 2.0\text{V}$
- Power Down Protection Provided on Inputs and Outputs
- Balanced Propagation Delays
- Designed for 4.5V to 5.5V Operating Range
- Low Noise:  $V_{OLP} = 1.6\text{V}$  (Max)
- Pin and Function Compatible with Other Standard Logic Families
- Latchup Performance Exceeds 300mA
- ESD Performance: HBM > 2000V; Machine Model > 200V
- Chip Complexity: 286 FETs or 71.5 Equivalent Gates

### LOGIC DIAGRAM

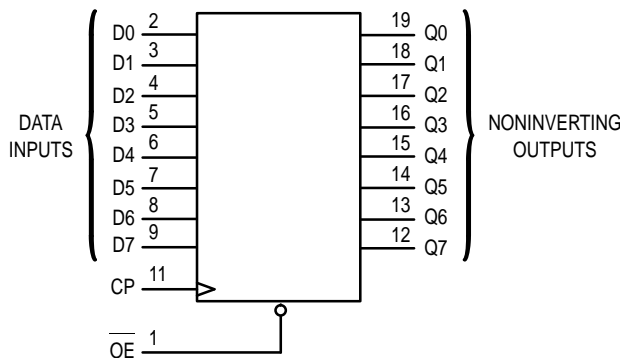

### FUNCTION TABLE

INPUTS			OUTPUT
OE	CP	D	Q
L		H	H
L		L	L
L	L, H,	X	No Change
H	X	X	Z

## MC74VHCT574A

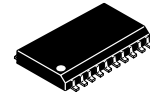

**DW SUFFIX**  
20-LEAD SOIC PACKAGE  
CASE 751D-04



**DT SUFFIX**  
20-LEAD TSSOP PACKAGE  
CASE 948E-02

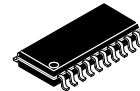

**M SUFFIX**  
20-LEAD SOIC EIAJ PACKAGE  
CASE 967-01

### ORDERING INFORMATION

MC74VHCTXXXADW	SOIC
MC74VHCTXXXADT	TSSOP
MC74VHCTXXXAM	SOIC EIAJ

### PIN ASSIGNMENT

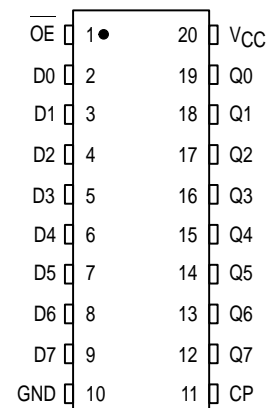

**MAXIMUM RATINGS\***

Symbol	Parameter	Value	Unit
V <sub>CC</sub>	DC Supply Voltage	- 0.5 to + 7.0	V
V <sub>in</sub>	DC Input Voltage	- 0.5 to + 7.0	V
V <sub>out</sub>	DC Output Voltage Outputs in 3-State High or Low State	- 0.5 to + 7.0 - 0.5 to V <sub>CC</sub> + 0.5	V
I <sub>IK</sub>	Input Diode Current	- 20	mA
I <sub>OK</sub>	Output Diode Current (V <sub>OUT</sub> < GND; V <sub>OUT</sub> > V <sub>CC</sub> )	± 20	mA
I <sub>out</sub>	DC Output Current, per Pin	± 25	mA
I <sub>CC</sub>	DC Supply Current, V <sub>CC</sub> and GND Pins	± 75	mA
P <sub>D</sub>	Power Dissipation in Still Air, SOIC Packages† TSSOP Package†	500 450	mW
T <sub>stg</sub>	Storage Temperature	- 65 to + 150	°C

This device contains protection circuitry to guard against damage due to high static voltages or electric fields. However, precautions must be taken to avoid applications of any voltage higher than maximum rated voltages to this high-impedance circuit. For proper operation, V<sub>in</sub> and V<sub>out</sub> should be constrained to the range GND ≤ (V<sub>in</sub> or V<sub>out</sub>) ≤ V<sub>CC</sub>. Unused inputs must always be tied to an appropriate logic voltage level (e.g., either GND or V<sub>CC</sub>). Unused outputs must be left open.

\* Absolute maximum continuous ratings are those values beyond which damage to the device may occur. Exposure to these conditions or conditions beyond those indicated may adversely affect device reliability. Functional operation under absolute-maximum-rated conditions is not implied.

†Derating — SOIC Packages: - 7 mW/°C from 65° to 125°C  
TSSOP Package: - 6.1 mW/°C from 65° to 125°C

**RECOMMENDED OPERATING CONDITIONS**

Symbol	Parameter	Min	Max	Unit
V <sub>CC</sub>	DC Supply Voltage	4.5	5.5	V
V <sub>in</sub>	DC Input Voltage	0	5.5	V
V <sub>out</sub>	DC Output Voltage Outputs in 3-State High or Low State	0 0	5.5 V <sub>CC</sub>	V
T <sub>A</sub>	Operating Temperature	- 40	+ 85	°C
t <sub>r</sub> , t <sub>f</sub>	Input Rise and Fall Time V <sub>CC</sub> = 5.0V ± 0.5V	0	20	ns/V

**DC ELECTRICAL CHARACTERISTICS**

Symbol	Parameter	Test Conditions	V <sub>CC</sub> V	T <sub>A</sub> = 25°C			T <sub>A</sub> = - 40 to 85°C		Unit
				Min	Typ	Max	Min	Max	
V <sub>IH</sub>	Minimum High-Level Input Voltage		4.5 to 5.5	2.0			2.0		V
V <sub>IL</sub>	Maximum Low-Level Input Voltage		4.5 to 5.5			0.8		0.8	V
V <sub>OH</sub>	Minimum High-Level Output Voltage V <sub>in</sub> = V <sub>IH</sub> or V <sub>IL</sub>	I <sub>OH</sub> = - 50µA	4.5	4.4	4.5		4.4		V
		I <sub>OH</sub> = - 8mA	4.5	3.94			3.80		
V <sub>OL</sub>	Maximum Low-Level Output Voltage V <sub>in</sub> = V <sub>IH</sub> or V <sub>IL</sub>	I <sub>OL</sub> = 50µA	4.5		0.0	0.1		0.1	V
		I <sub>OL</sub> = 8mA	4.5			0.36		0.44	
I <sub>in</sub>	Maximum Input Leakage Current	V <sub>in</sub> = 5.5 V or GND	0 to 5.5			± 0.1		± 1.0	µA
I <sub>OZ</sub>	Maximum 3-State Leakage Current	V <sub>in</sub> = V <sub>IL</sub> or V <sub>IH</sub> V <sub>out</sub> = V <sub>CC</sub> or GND	5.5			± 0.25		± 2.5	µA
I <sub>CC</sub>	Maximum Quiescent Supply Current	V <sub>in</sub> = V <sub>CC</sub> or GND	5.5			4.0		40.0	µA

## DC ELECTRICAL CHARACTERISTICS

Symbol	Parameter	Test Conditions	V <sub>CC</sub> V	T <sub>A</sub> = 25°C			T <sub>A</sub> = -40 to 85°C		Unit
				Min	Typ	Max	Min	Max	
I <sub>CC</sub> T	Quiescent Supply Current	Per Input: V <sub>IN</sub> = 3.4V Other Input: V <sub>CC</sub> or GND	5.5			1.35		1.50	mA
I <sub>OP</sub> D	Output Leakage Current	V <sub>OUT</sub> = 5.5V	0			0.5		5.0	μA

AC ELECTRICAL CHARACTERISTICS (Input t<sub>r</sub> = t<sub>f</sub> = 3.0ns)

Symbol	Parameter	Test Conditions	T <sub>A</sub> = 25°C			T <sub>A</sub> = -40 to 85°C		Unit
			Min	Typ	Max	Min	Max	
f <sub>max</sub>	Maximum Clock Frequency (50% Duty Cycle)	V <sub>CC</sub> = 5.0 ± 0.5V C <sub>L</sub> = 15pF C <sub>L</sub> = 50pF	90 85	140 130		80 95		MHz
t <sub>PL</sub> H, t <sub>PH</sub> L	Maximum Propagation Delay, CP to Q	V <sub>CC</sub> = 5.0 ± 0.5V C <sub>L</sub> = 15pF C <sub>L</sub> = 50pF		4.1 5.6	9.4 10.4	1.0 1.0	10.5 11.5	ns
t <sub>PZ</sub> L, t <sub>PZ</sub> H	Output Enable Time, OE to Q	V <sub>CC</sub> = 5.0 ± 0.5V R <sub>L</sub> = 1kΩ C <sub>L</sub> = 50pF		6.5 7.3	10.2 11.2	1.0 1.0	11.5 12.5	ns
t <sub>PL</sub> Z, t <sub>PH</sub> Z	Output Disable Time, OE to Q	V <sub>CC</sub> = 5.0 ± 0.5V R <sub>L</sub> = 1kΩ C <sub>L</sub> = 50pF		7.0	11.2	1.0	12.0	ns
t <sub>OS</sub> LH, t <sub>OS</sub> HL	Output to Output Skew	V <sub>CC</sub> = 5.0 ± 0.5V C <sub>L</sub> = 50pF (Note NO TAG)			1.0		1.0	ns
C <sub>in</sub>	Maximum Input Capacitance			4	10		10	pF
C <sub>out</sub>	Maximum Three-State Output Capacitance, Output in High-Impedance State			9				pF

C <sub>PD</sub>	Power Dissipation Capacitance (Note NO TAG)	Typical @ 25°C, V <sub>CC</sub> = 5.0V		pF
		25		

- Parameter guaranteed by design. t<sub>OS</sub>LH = |t<sub>PL</sub>H<sub>m</sub> - t<sub>PL</sub>H<sub>n</sub>|, t<sub>OS</sub>HL = |t<sub>PH</sub>L<sub>m</sub> - t<sub>PH</sub>L<sub>n</sub>|.
- C<sub>PD</sub> is defined as the value of the internal equivalent capacitance which is calculated from the operating current consumption without load. Average operating current can be obtained by the equation: I<sub>CC</sub>(OPR) = C<sub>PD</sub> • V<sub>CC</sub> • f<sub>in</sub> + I<sub>CC</sub>/8 (per flip-flop). C<sub>PD</sub> is used to determine the no-load dynamic power consumption; P<sub>D</sub> = C<sub>PD</sub> • V<sub>CC</sub><sup>2</sup> • f<sub>in</sub> + I<sub>CC</sub> • V<sub>CC</sub>.

NOISE CHARACTERISTICS (Input t<sub>r</sub> = t<sub>f</sub> = 3.0ns, C<sub>L</sub> = 50pF, V<sub>CC</sub> = 5.0V)

Symbol	Parameter	T <sub>A</sub> = 25°C		Unit
		Typ	Max	
V <sub>OL</sub> P	Quiet Output Maximum Dynamic V <sub>OL</sub>	1.2	1.6	V
V <sub>OL</sub> V	Quiet Output Minimum Dynamic V <sub>OL</sub>	-1.2	-1.6	V
V <sub>I</sub> H <sub>D</sub>	Minimum High Level Dynamic Input Voltage		2.0	V
V <sub>I</sub> L <sub>D</sub>	Maximum Low Level Dynamic Input Voltage		0.8	V

TIMING REQUIREMENTS (Input t<sub>r</sub> = t<sub>f</sub> = 3.0ns)

Symbol	Parameter	Test Conditions	T <sub>A</sub> = 25°C		T <sub>A</sub> = -40 to 85°C	Unit
			Typ	Limit	Limit	
t <sub>su</sub>	Minimum Setup Time, D to CP	V <sub>CC</sub> = 5.0 ± 0.5 V		6.5	8.5	ns
t <sub>h</sub>	Minimum Hold Time, CP to D	V <sub>CC</sub> = 5.0 ± 0.5 V		2.5	2.5	ns
t <sub>w</sub>	Minimum Pulse Width, CP	V <sub>CC</sub> = 5.0 ± 0.5 V		2.5	2.5	ns

SWITCHING WAVEFORMS

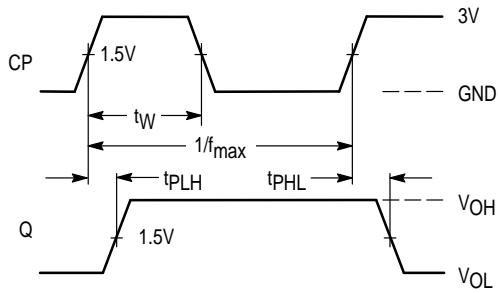

Figure 1.

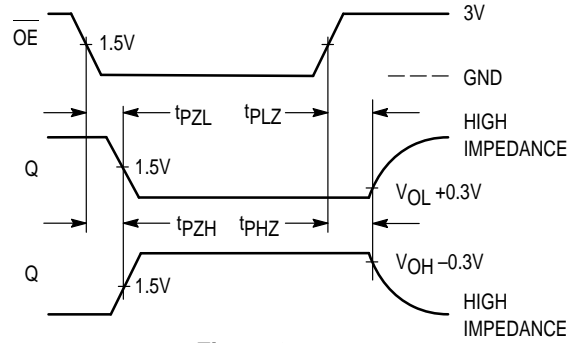

Figure 2.

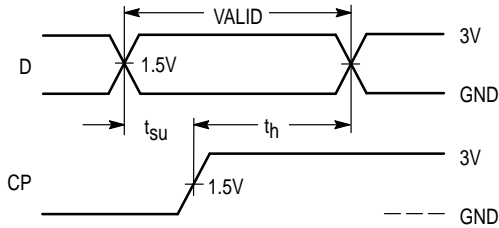
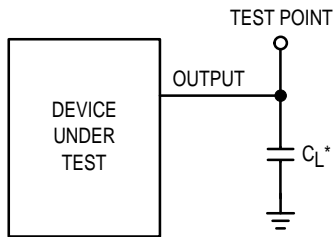
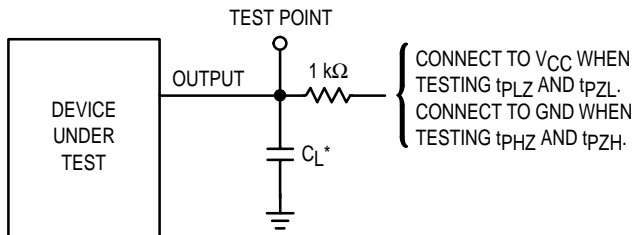

Figure 3.



\* Includes all probe and jig capacitance

Figure 4.



\* Includes all probe and jig capacitance

Figure 5. Test Circuit

EXPANDED LOGIC DIAGRAM

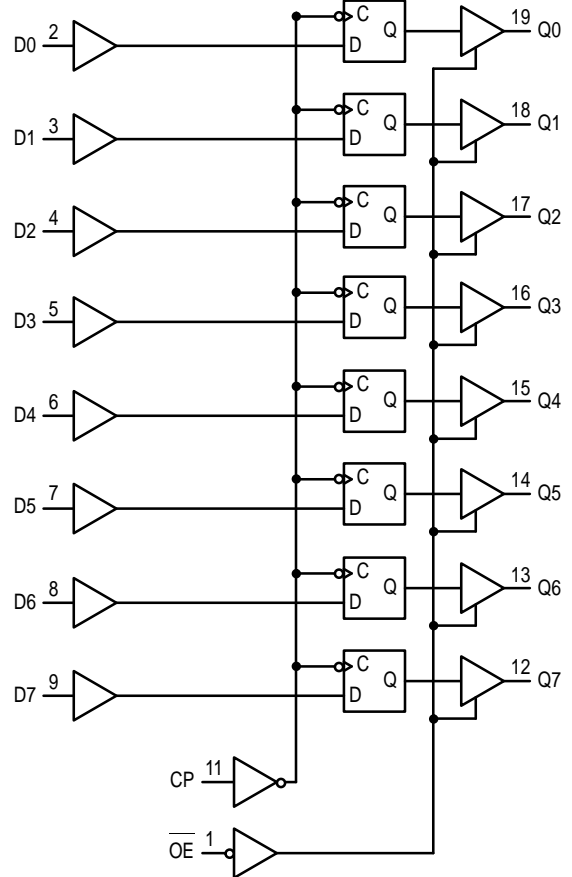

OUTLINE DIMENSIONS

DW SUFFIX  
PLASTIC SOIC PACKAGE  
CASE 751D-04  
ISSUE E

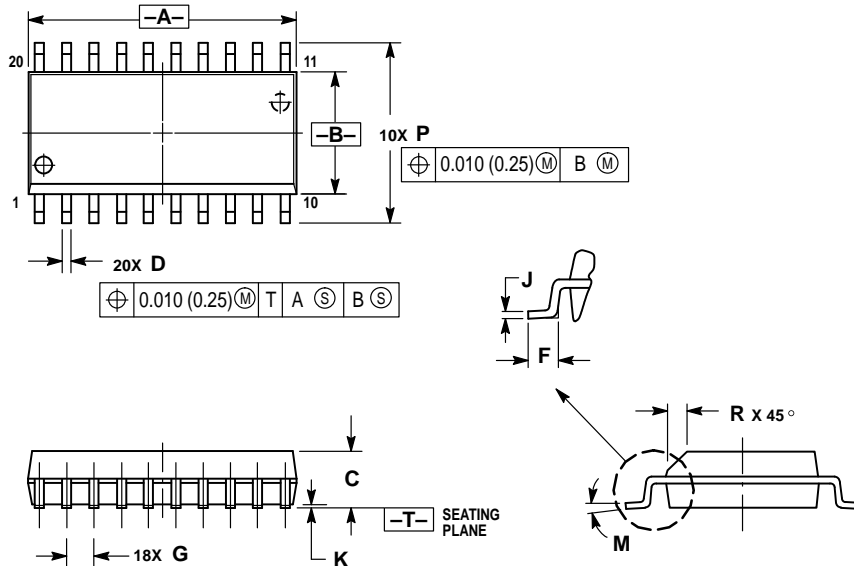

- NOTES:
1. DIMENSIONING AND TOLERANCING PER ANSI Y14.5M, 1982.
  2. CONTROLLING DIMENSION: MILLIMETER.
  3. DIMENSIONS A AND B DO NOT INCLUDE MOLD PROTRUSION.
  4. MAXIMUM MOLD PROTRUSION 0.150 (0.006) PER SIDE.
  5. DIMENSION D DOES NOT INCLUDE DAMBAR PROTRUSION. ALLOWABLE DAMBAR PROTRUSION SHALL BE 0.13 (0.005) TOTAL IN EXCESS OF D DIMENSION AT MAXIMUM MATERIAL CONDITION.

DIM	MILLIMETERS		INCHES	
	MIN	MAX	MIN	MAX
A	12.65	12.95	0.499	0.510
B	7.40	7.60	0.292	0.299
C	2.35	2.65	0.093	0.104
D	0.35	0.49	0.014	0.019
F	0.50	0.90	0.020	0.035
G	1.27 BSC		0.050 BSC	
J	0.25	0.32	0.010	0.012
K	0.10	0.25	0.004	0.009
M	0°	7°	0°	7°
P	10.05	10.55	0.395	0.415
R	0.25	0.75	0.010	0.029

DT SUFFIX  
PLASTIC TSSOP PACKAGE  
CASE 948E-02  
ISSUE A

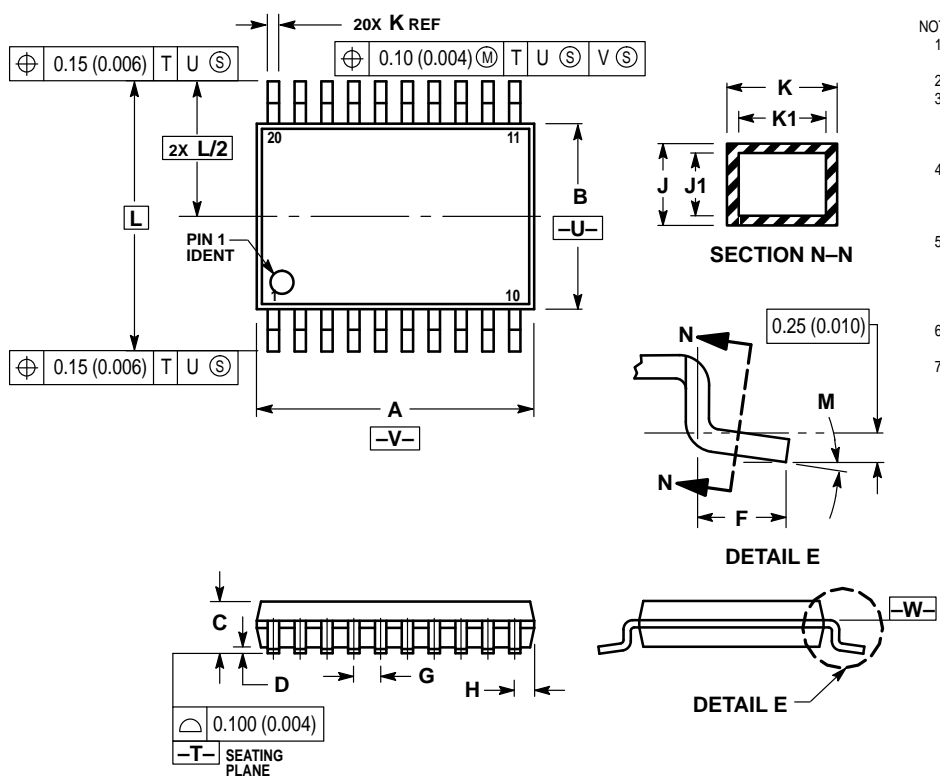

- NOTES:
1. DIMENSIONING AND TOLERANCING PER ANSI Y14.5M, 1982.
  2. CONTROLLING DIMENSION: MILLIMETER.
  3. DIMENSION A DOES NOT INCLUDE MOLD FLASH, PROTRUSIONS OR GATE BURRS. MOLD FLASH OR GATE BURRS SHALL NOT EXCEED 0.15 (0.006) PER SIDE.
  4. DIMENSION B DOES NOT INCLUDE INTERLEAD FLASH OR PROTRUSION. INTERLEAD FLASH OR PROTRUSION SHALL NOT EXCEED 0.25 (0.010) PER SIDE.
  5. DIMENSION K DOES NOT INCLUDE DAMBAR PROTRUSION. ALLOWABLE DAMBAR PROTRUSION SHALL BE 0.08 (0.003) TOTAL IN EXCESS OF THE K DIMENSION AT MAXIMUM MATERIAL CONDITION.
  6. TERMINAL NUMBERS ARE SHOWN FOR REFERENCE ONLY.
  7. DIMENSION A AND B ARE TO BE DETERMINED AT DATUM PLANE -W-.

DIM	MILLIMETERS		INCHES	
	MIN	MAX	MIN	MAX
A	6.40	6.60	0.252	0.260
B	4.30	4.50	0.169	0.177
C	—	1.20	—	0.047
D	0.05	0.15	0.002	0.006
F	0.50	0.75	0.020	0.030
G	0.65 BSC		0.026 BSC	
H	0.27	0.37	0.011	0.015
J	0.09	0.20	0.004	0.008
J1	0.09	0.16	0.004	0.006
K	0.19	0.30	0.007	0.012
K1	0.19	0.25	0.007	0.010
L	6.40 BSC		0.252 BSC	
M	0°	8°	0°	8°

OUTLINE DIMENSIONS

M SUFFIX  
PLASTIC SOIC EIAJ PACKAGE  
CASE 967-01  
ISSUE O

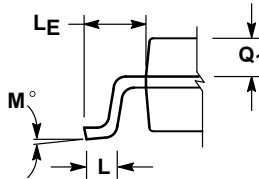
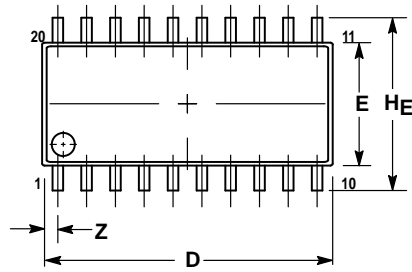

DETAIL P

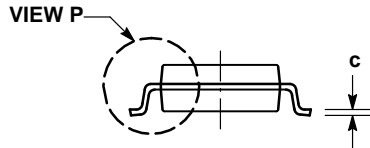
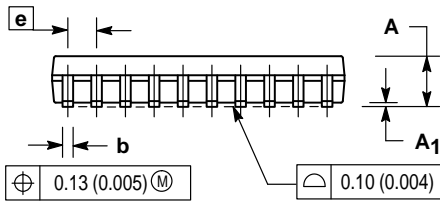

NOTES:

1. DIMENSIONING AND TOLERANCING PER ANSI Y14.5M, 1982.
2. CONTROLLING DIMENSION: MILLIMETER.
3. DIMENSIONS D AND E DO NOT INCLUDE MOLD FLASH OR PROTRUSIONS AND ARE MEASURED AT THE PARTING LINE. MOLD FLASH OR PROTRUSIONS SHALL NOT EXCEED 0.15 (0.006) PER SIDE.
4. TERMINAL NUMBERS ARE SHOWN FOR REFERENCE ONLY.
5. THE LEAD WIDTH DIMENSION (b) DOES NOT INCLUDE DAMBAR PROTRUSION. ALLOWABLE DAMBAR PROTRUSION SHALL BE 0.08 (0.003) TOTAL IN EXCESS OF THE LEAD WIDTH DIMENSION AT MAXIMUM MATERIAL CONDITION. DAMBAR CANNOT BE LOCATED ON THE LOWER RADIUS OR THE FOOT. MINIMUM SPACE BETWEEN PROTRUSIONS AND ADJACENT LEAD TO BE 0.46 (0.018).

DIM	MILLIMETERS		INCHES	
	MIN	MAX	MIN	MAX
A	—	2.05	—	0.081
A <sub>1</sub>	0.05	0.20	0.002	0.008
b	0.35	0.50	0.014	0.020
c	0.18	0.27	0.007	0.011
D	12.35	12.80	0.486	0.504
E	5.10	5.45	0.201	0.215
e	1.27	BSC	0.050	BSC
H <sub>E</sub>	7.40	8.20	0.291	0.323
L	0.50	0.85	0.020	0.033
L <sub>E</sub>	1.10	1.50	0.043	0.059
M	0°	10°	0°	10°
Q <sub>1</sub>	0.70	0.90	0.028	0.035
Z	—	0.81	—	0.032

Motorola reserves the right to make changes without further notice to any products herein. Motorola makes no warranty, representation or guarantee regarding the suitability of its products for any particular purpose, nor does Motorola assume any liability arising out of the application or use of any product or circuit, and specifically disclaims any and all liability, including without limitation consequential or incidental damages. "Typical" parameters which may be provided in Motorola data sheets and/or specifications can and do vary in different applications and actual performance may vary over time. All operating parameters, including "Typicals" must be validated for each customer application by customer's technical experts. Motorola does not convey any license under its patent rights nor the rights of others. Motorola products are not designed, intended, or authorized for use as components in systems intended for surgical implant into the body, or other applications intended to support or sustain life, or for any other application in which the failure of the Motorola product could create a situation where personal injury or death may occur. Should Buyer purchase or use Motorola products for any such unintended or unauthorized application, Buyer shall indemnify and hold Motorola and its officers, employees, subsidiaries, affiliates, and distributors harmless against all claims, costs, damages, and expenses, and reasonable attorney fees arising out of, directly or indirectly, any claim of personal injury or death associated with such unintended or unauthorized use, even if such claim alleges that Motorola was negligent regarding the design or manufacture of the part. Motorola and are registered trademarks of Motorola, Inc. Motorola, Inc. is an Equal Opportunity/Affirmative Action Employer.

Mfax is a trademark of Motorola, Inc.

How to reach us:

USA/EUROPE/Locations Not Listed: Motorola Literature Distribution; P.O. Box 5405, Denver, Colorado 80217. 303-675-2140 or 1-800-441-2447

JAPAN: Nippon Motorola Ltd.: SPD, Strategic Planning Office, 4-32-1, Nishi-Gotanda, Shinagawa-ku, Tokyo 141, Japan. 81-3-5487-8488

Mfax™: RMFAX0@email.sps.mot.com – TOUCHTONE 602-244-6609  
– US & Canada ONLY 1-800-774-1848

ASIA/PACIFIC: Motorola Semiconductors H.K. Ltd.; 8B Tai Ping Industrial Park, 51 Ting Kok Road, Tai Po, N.T., Hong Kong. 852-26629298

INTERNET: <http://motorola.com/sps>