

MITSUBISHI RF POWER MODULE  
**M67766C**

806-825MHz, 12.5V, 16W, DIGITAL MOBILE RADIO

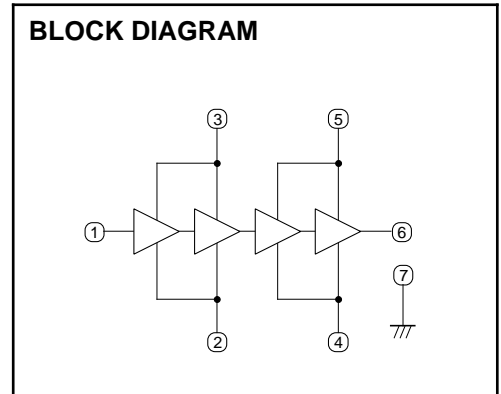
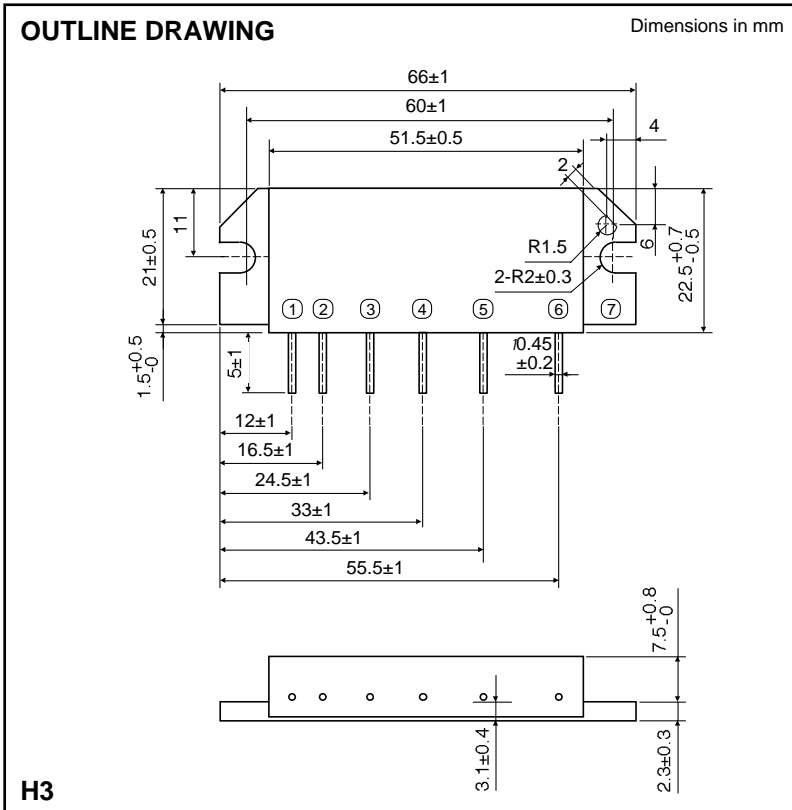

- PIN:
- ① Pin : RF INPUT
  - ② VBB1 : 1st. BASE BIAS SUPPLY
  - ③ VCC1: 1st. COLLECTOR BIAS SUPPLY
  - ④ VBB2: 2nd. BASE BIAS SUPPLY
  - ⑤ VCC2: 2nd. COLLECTOR BIAS SUPPLY
  - ⑥ Po : RF OUTPUT
  - ⑦ GND: FIN

**ABSOLUTE MAXIMUM RATINGS** (Tc=25°C unless otherwise noted)

Symbol	Parameter	Conditions	Ratings	Unit
VCC1	Supply voltage	ZG=ZL=50 , VBB1=8V	9	V
VCC2	Supply voltage	ZG=ZL=50 , VBB2=8V	17	V
VBB1	Supply voltage	ZG=ZL=50 , VCC1=8V	9	V
VBB2	Supply voltage	ZG=ZL=50 , VCC2=12.5V	9	V
ICC	Total current	ZG=ZL=50	3	A
P <sub>in</sub> (max)	Input power	ZG=ZL=50 , VCC2=12.5V	10	mW
P <sub>O</sub> (max)	Output power	ZG=ZL=50 , VCC2=12.5V	20	W
T <sub>C</sub> (OP)	Operation case temperature	ZG=ZL=50	-30 to +110	°C
T <sub>stg</sub>	Storage temperature		-40 to +110	°C

Note. Above parameters are guaranteed independently.

**ELECTRICAL CHARACTERISTICS** (Tc=25°C unless otherwise noted)

Symbol	Parameter	Test conditions	Limits		Unit
			Min	Max	
f	Frequency range		806	825	MHz
P <sub>O</sub>	Output power	VCC1=VBB=8V, VCC2=12.5V, P <sub>in</sub> =10dBm, ZG=ZL=50	16		W
η	Total efficiency	VCC1=VBB=8V, VCC2=12.5V, ZG=ZL=50	20		%
2f <sub>o</sub>	2nd. harmonic			-30	dBc
in	Input VSWR	PO=6W (P <sub>in</sub> :controlled)		2.5	-
IMD3	3rd. internal modulation	VCC1=VBB=8V, VCC2=12.5V, ZG=ZL=50 , PO(AVE)=6W(P <sub>in</sub> :controlled), 2tone, f=10kHz		-24	dBc
IMD5	5th. internal modulation			-28	dBc
-	Load VSWR tolerance	VCC1=8.5V, VBB=8V, VCC2=17V, PO=20W (P <sub>in</sub> :controlled), ZG=50 , Load VSWR < 2:1	No degradation or destroy		-

Note. Above parameters, ratings, limits and test conditions are subject to change.

**TYPICAL PERFORMANCE DATA**

**OUTPUT POWER, EACH CURRENT VS. FREQUENCY**

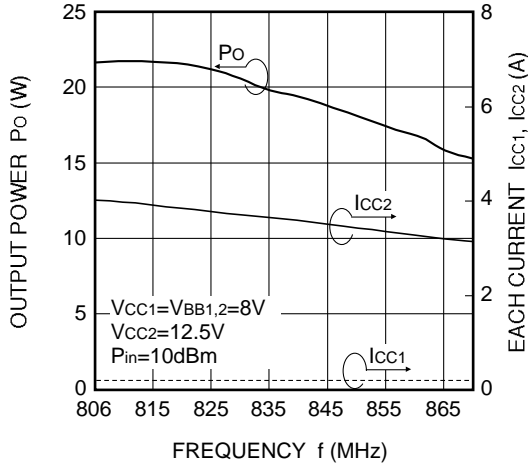

**SUPRIUS, IMD VS. FREQUENCY**

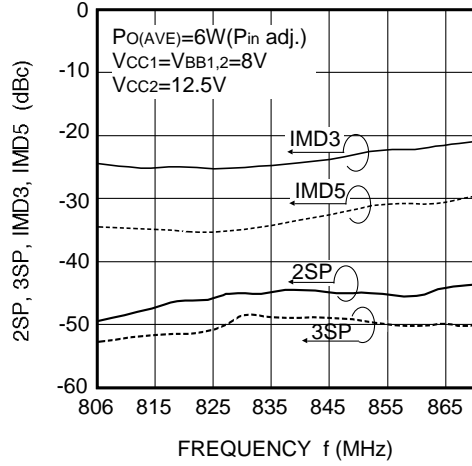

**INPUT POWER, INPUT VSWR, TOTAL EFFICIENCY VS. FREQUENCY**

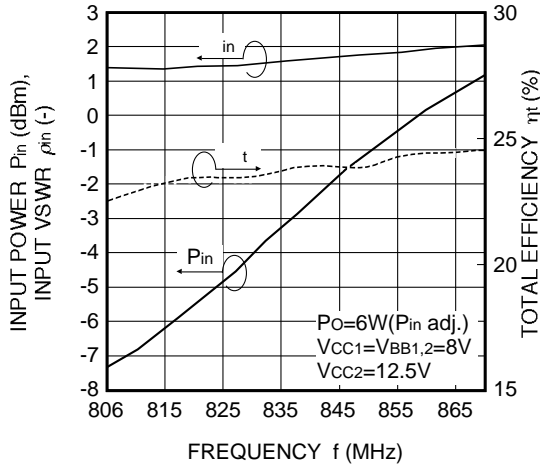

**OUTPUT POWER, EACH CURRENT VS. INPUT POWER**

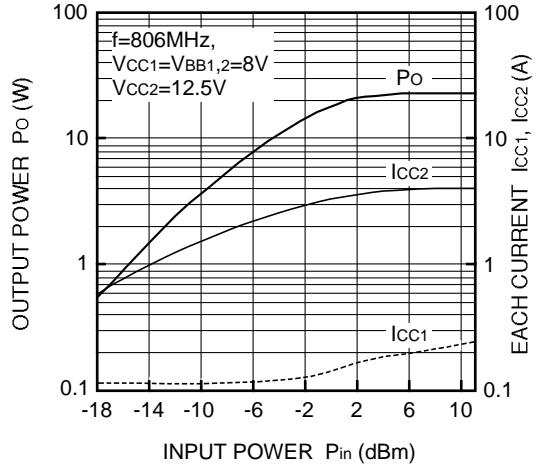

**OUTPUT POWER, EACH CURRENT VS. INPUT POWER**

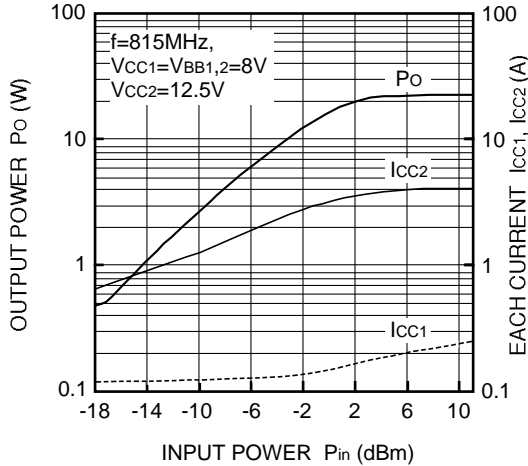

**OUTPUT POWER, EACH CURRENT VS. INPUT POWER**

