

M57716

430-450MHz, 12.5V, 17W, SSB MOBILE RADIO

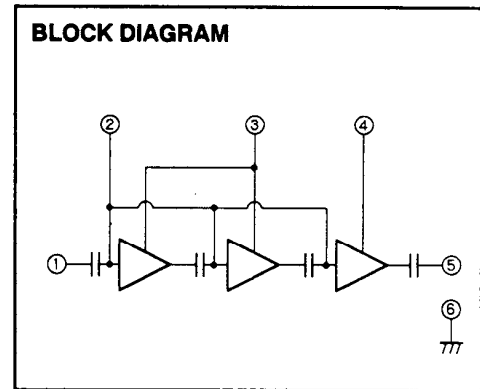
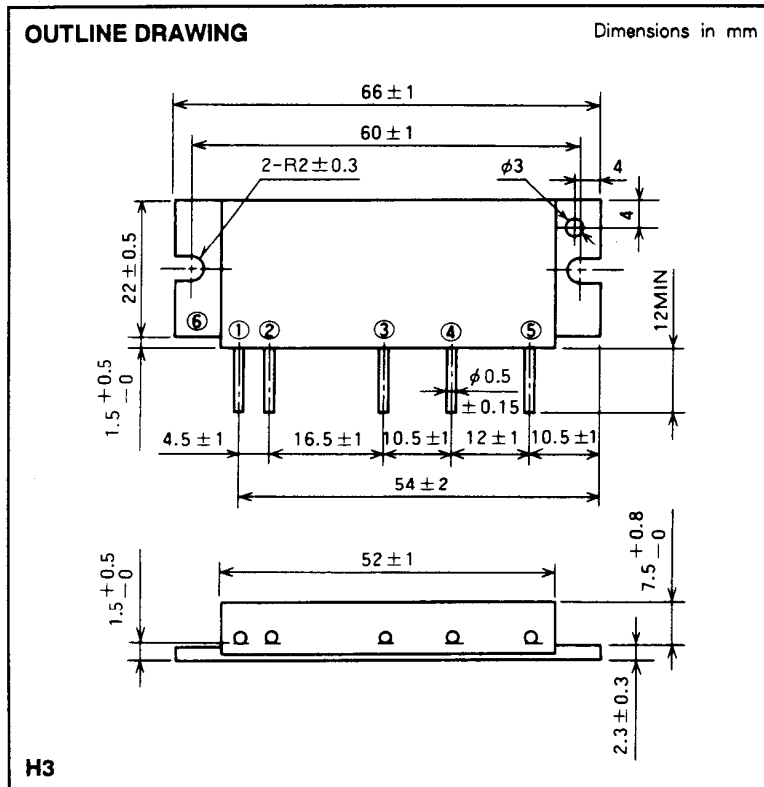

- PIN :
- ① Pin : RF INPUT
 - ② V_{BB} : BASE BIAS SUPPLY
 - ③ V_{CC1} : 1st. DC SUPPLY
 - ④ V_{CC2} : 2nd. DC SUPPLY
 - ⑤ P_o : RF OUTPUT
 - ⑥ GND : FIN

ABSOLUTE MAXIMUM RATINGS (T_c = 25 °C unless otherwise noted)

Symbol	Parameter	Conditions	Ratings	Unit
V _{cc}	Supply voltage		17	V
V _{BB}	Base bias		10	V
I _{cc}	Total current		6	A
P _{in(max)}	Input power	Z _G = Z _L = 50 Ω	0.3	W
P _{o(max)}	Output power	Z _G = Z _L = 50 Ω	28	W
T _{c(OP)}	Operation case temperature		- 30 to 110	°C
T _{stg}	Storage temperature		- 40 to 110	°C

Note. Above parameters are guaranteed independently.

ELECTRICAL CHARACTERISTICS (T_c = 25 °C unless otherwise noted)

Symbol	Parameter	Test conditions	Limits		Unit
			Min	Max	
f	Frequency range	P _{in} = 0.2W V _{cc} = 12.5V V _{BB} = 9V Z _G = Z _L = 50 Ω	430	450	MHz
P _o	Output power		17		W
η _T	Total efficiency		35		%
2f _o	2nd. harmonic			- 30	
ρ _{in}	Input VSWR			2.5	-
-	Load VSWR tolerance	V _{cc} = 15.2V, V _{BB} = 9V P _o = 14W (P _{in} : controlled) Load VSWR=20:1 (All phase), 2sec. Z _G = 50 Ω	No degradation or destroy		-

Note. Above parameters, ratings, limits and conditions are subject to change.

TYPICAL PERFORMANCE DATA

OUTPUT POWER, POWER GAIN, TOTAL EFFICIENCY, INPUT VSWR VS. FREQUENCY CHARACTERISTICS (M57716)

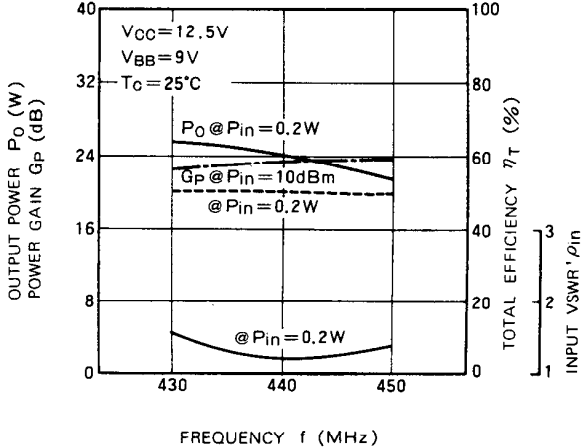

OUTPUT POWER, TOTAL COLLECTOR CURRENT VS. INPUT POWER

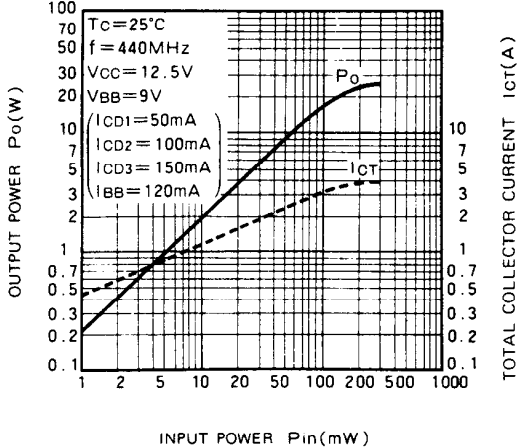

INTERMODULATION DISTORTION VS. OUTPUT POWER

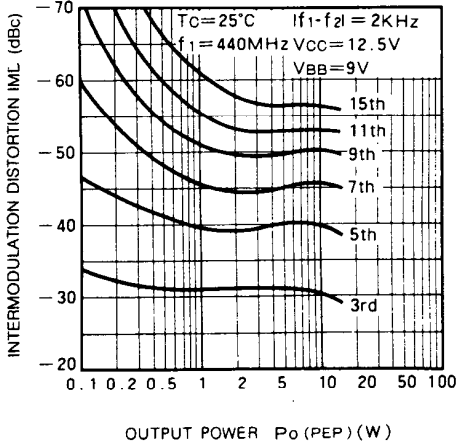

OUTPUT POWER VS. DC SUPPLY VOLTAGE

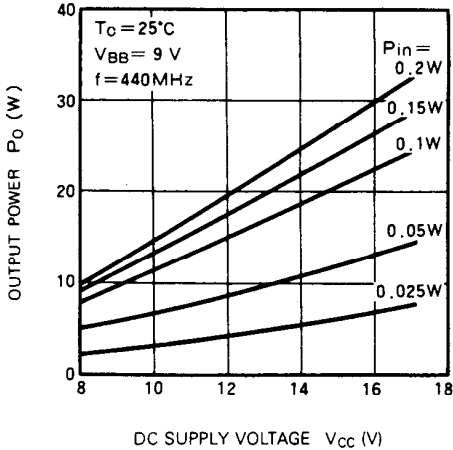

INPUT IMPEDANCE, OUTPUT IMPEDANCE VS. FREQUENCY

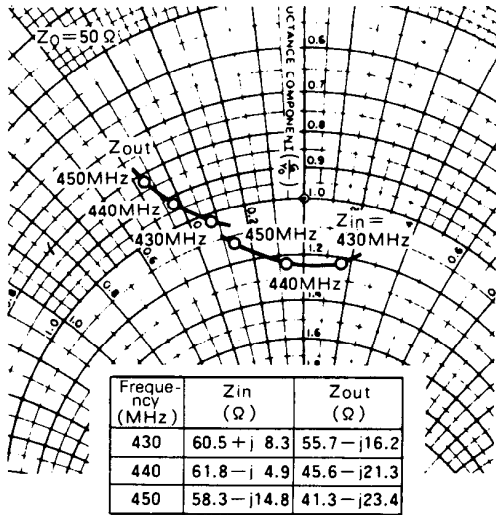

Test condition : V_{CC} = 12.5V, V_{BB} = 9V
P_{in} = 0.2W

DESIGN CONSIDERATION OF HEAT RADIATION.

Please refer to following consideration when designing heat sink.

1. Junction temperature of incorporated transistors at standard operation.

(1) Thermal resistance between junction and package of incorporated transistors.

- a) First stage transistor
R_{th(j-c)1} = 15°C/W (Typ.)
- b) Second stage transistor
R_{th(j-c)2} = 6°C/W (Typ.)
- c) Final stage transistor
R_{th(j-c)3} = 2°C/W (Typ.)

(2) Junction temperature of incorporated transistors at standard operation.

- Conditions for standard operation.
P_O = 14W, V_{CC} = 12.5V, P_{in} = 80mW, η_T = 35% (minimum rating), P_{O1} (Note 1) = 1W, P_{O2} (2) = 4.5W, I_T = 3.2A (I_{T1} (3) = 0.15A, I_{T2} (4) = 0.55A, I_{T3} (5) = 2.5A)
Note 1: Output power of the first stage transistor
Note 2: Output power of the second stage transistor
Note 3: Circuit current of the first stage transistor
Note 4: Circuit current of the second stage transistor
Note 5: Circuit current of the final stage transistor
- Junction temperature of the first stage transistor
T_{j1} = (V_{CC} × I_{T1} - P_{O1} + P_{in}) × R_{th(j-c)1} + T_c (6)
= (12.5 × 0.15 - 1 + 0.08) × 15 + T_c
= 14.4 + T_c (°C)
Note 6: Package temperature of device

- Junction temperature of the second stage transistor
T_{j2} = (V_{CC} × I_{T2} - P_{O2} + P_{O1}) × R_{th(j-c)2} + T_c
= (12.5 × 0.55 - 4.5 + 1) × 6 + T_c
= 20.3 + T_c (°C)
- Junction temperature of the final stage transistor
T_{j3} = (V_{CC} × I_{T3} - P_O + P_{O2}) × R_{th(j-c)3} + T_c
= (12.5 × 2.5 - 14 + 4.5) × 2 + T_c
= 43.5 + T_c (°C)

2. Heat sink design

In thermal design of heat sink, try to keep the package temperature at the upper limit of the operating ambient temperature (normally T_a = 60°C) and at the output power of 14W below 90°C.

The thermal resistance R_{th(c-a)} (7) of the heat sink to realize this:

$$\text{Note 7: } R_{th(c-a)} = \frac{T_c - T_a}{(P_O/\eta_T) - P_O + P_{in}} = \frac{90 - 60}{(14/0.35) - 14 + 0.08} = 1.15 \text{ (°C/W)}$$

Note 7: Inclusive of the contact thermal resistance between device and heat sink.

Mounting the heat sink of the above thermal resistance on the device,

$$T_{j1} = 104.4^\circ\text{C}, T_{j2} = 110.3^\circ\text{C}, T_{j3} = 133.5^\circ\text{C at } T_a = 60^\circ\text{C}, T_c = 90^\circ\text{C.}$$

In the annual average of ambient temperature is 30°C,
T_{j1} = 74.4°C, T_{j2} = 80.3°C, T_{j3} = 103.5°C.
As the maximum junction temperature of these incorporated transistors T_{jmax} are 175°C, application under fully derated condition is ensured.