

CR3AMZ

LOW POWER, STROBE USE
NON-INSULATED TYPE, GLASS PASSIVATION TYPE

CR3AMZ



- $I_T (AV)$ **0.4A**
- V_{DRM} **400V**
- I_{GT} **30mA**

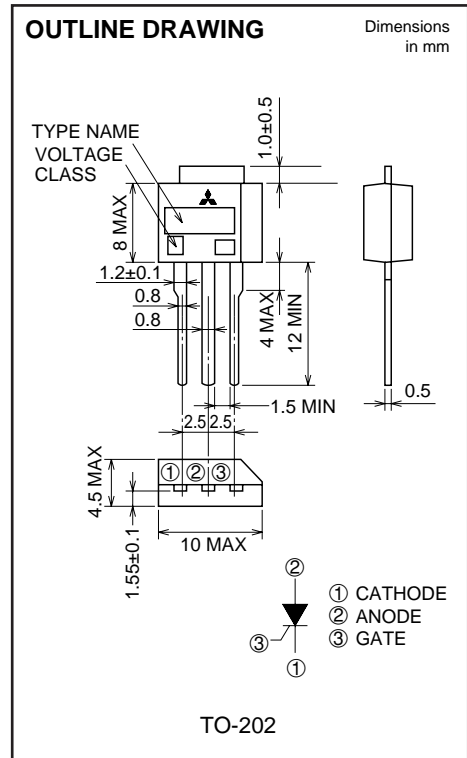

APPLICATION

Automatic strobe flasher

MAXIMUM RATINGS

Symbol	Parameter	Voltage class		Unit
		8		
VRRM	Repetitive peak reverse voltage	400		V
VRSM	Non-repetitive peak reverse voltage	480		V
VDRM	Repetitive peak off-state voltage	400		V
VDSM	Non-repetitive peak off-state voltage	480		V

Symbol	Parameter	Conditions	Ratings	Unit
$I_T (AV)$	Average on-state current	Commercial frequency, sine half wave, 180° conduction,	0.4	A
I_{TRM}	Repetitive peak on-state current *1	$C_M=700\mu F$ with discharge current	200	A
PGM	Peak gate power dissipation		0.5	W
PG (AV)	Average gate power dissipation		0.1	W
VFGM	Peak gate forward voltage		6	V
IFGM	Peak gate forward current		0.5	A
T_j	Junction temperature		-40 ~ +125	°C
T_{stg}	Storage temperature		-40 ~ +125	°C
—	Weight	Typical value	1.1	g

*1. Refer to sections 1, 2 on STROBE FLASHER APPLICATION shown in the last sheet for CR3JM.

CR3AMZ

LOW POWER, STROBE USE
NON-INSULATED TYPE, GLASS PASSIVATION TYPE

ELECTRICAL CHARACTERISTICS

Symbol	Parameter	Test conditions	Limits			Unit
			Min.	Typ.	Max.	
IRRM	Repetitive peak reverse current	$T_j=25^\circ\text{C}$, V_{RRM} applied	—	—	0.1	mA
IDRM	Repetitive peak off-state current	$T_j=25^\circ\text{C}$, V_{DRM} applied	—	—	0.1	mA
V _{TM}	On-state voltage	$T_a=25^\circ\text{C}$, $I_{TM}=3\text{A}$, Instantaneous value	—	—	2.0	V
V _{GT}	Gate trigger voltage	$T_j=25^\circ\text{C}$, $V_D=6\text{V}$, $R_L=6\Omega$	—	—	1.5	V
V _{GD}	Gate non-trigger voltage	$T_j=125^\circ\text{C}$, $V_D=1/2V_{DRM}$	0.1	—	—	V
I _{GT}	Gate trigger current	$T_j=25^\circ\text{C}$, $V_D=6\text{V}$, $R_L=6\Omega$	—	—	30	mA
C _c	Commutating capacitor *2	$C_M=700\mu\text{F}$, $V_{CM}=350\text{V}$, $I_{TM}=200\text{A}$, $L=25\mu\text{H}$, $T_a=25^\circ\text{C}$	—	—	2.2	μF

*2. Refer to section 3 on STROBE FLASHER APPLICATION shown in the last sheet for CR3JM.

Fig 1. TEST CIRCUIT FOR COMMUTATING CAPACITOR

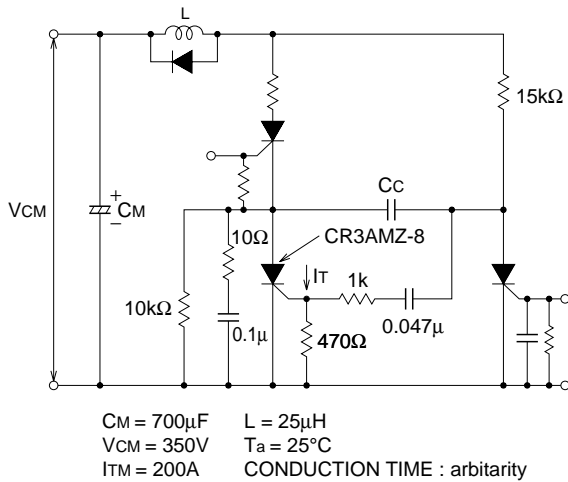

PERFORMANCE CURVES

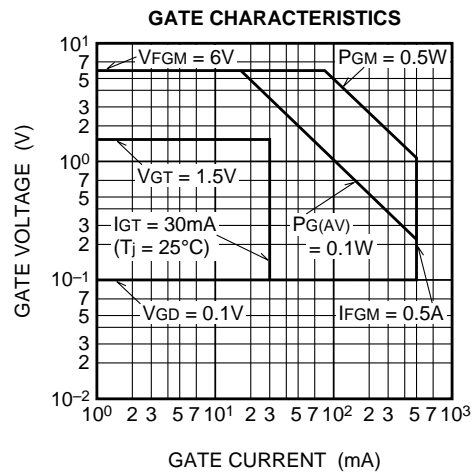
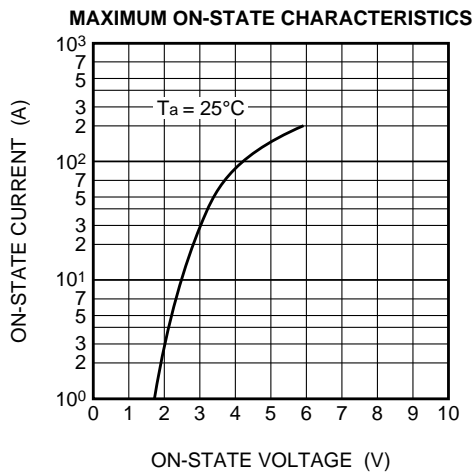

CR3AMZ

LOW POWER, STROBE USE
NON-INSULATED TYPE, GLASS PASSIVATION TYPE

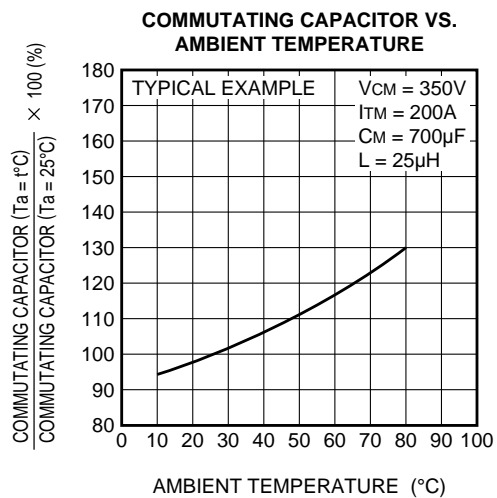
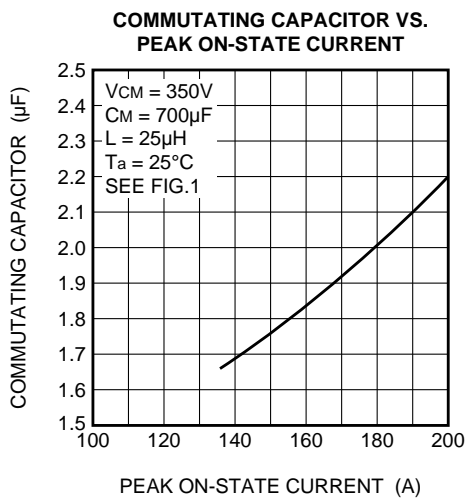
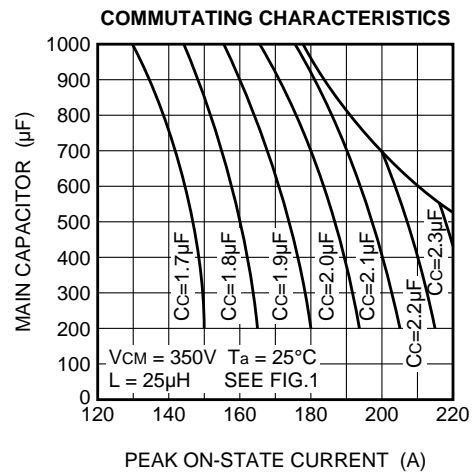
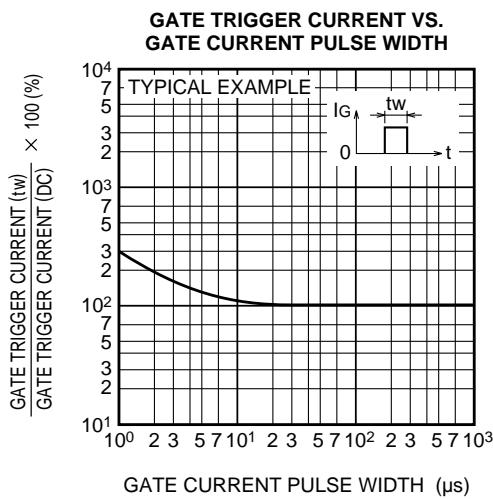
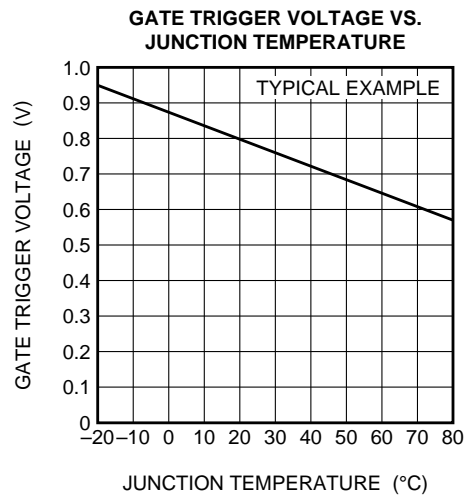
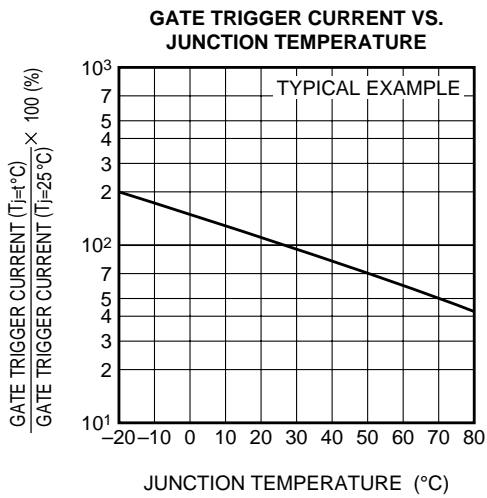

CR3AMZ

LOW POWER, STROBE USE
NON-INSULATED TYPE, GLASS PASSIVATION TYPE

HOLDING CURRENT VS. JUNCTION TEMPERATURE

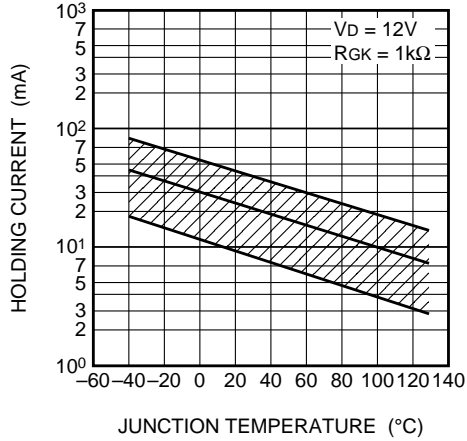

BREAKOVER VOLTAGE VS. JUNCTION TEMPERATURE

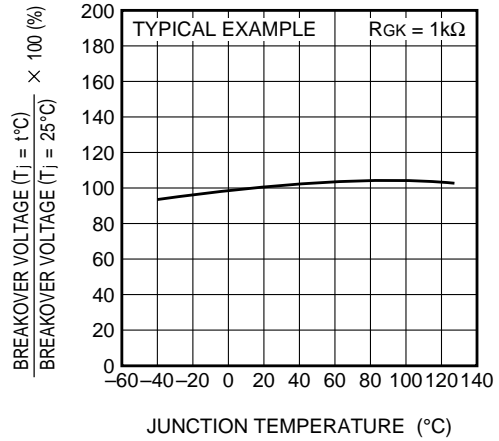

PEAK OFF-STATE CURRENT VS. JUNCTION TEMPERATURE

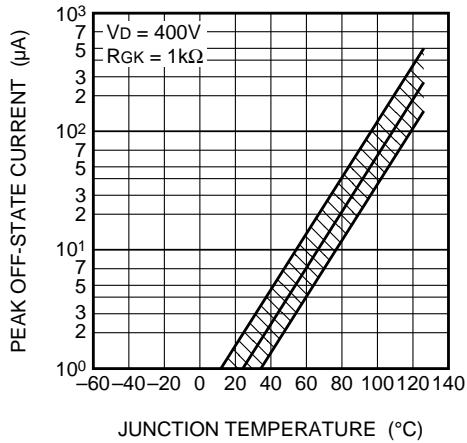

PEAK REVERSE CURRENT VS. JUNCTION TEMPERATURE

