



Micro Commercial Components  
 21201 Itasca Street Chatsworth  
 CA 91311  
 Phone: (818) 701-4933  
 Fax: (818) 701-4939

# UPS5817 THRU UPS5819

## Features

- High Power Surface Mount Package
- Guard Ring Protection
- Low Forward Voltage
- Integral Heat Sink/Locking Tabs
- Compatible with Automatic Insertion Equipment

## Maximum Ratings

- Operating Temperature: -55°C to +150°C
- Storage Temperature: -55°C to +150°C
- Maximum Thermal Resistance; 30°C/W Junction To Tab
- Maximum Thermal Resistance; 10°C/W Junction To Bottom

MCC Catalog Number	Device Marking	Maximum Recurrent Peak Reverse Voltage	Maximum RMS Voltage	Maximum DC Blocking Voltage
UPS5817	UPS5817	20V	14V	20V
UPS5818	UPS5818	30V	21V	30V
UPS5819	UPS5819	40V	28V	40V

## 1 Amp Schottky Rectifier 20 to 40 Volts

### DO-216AA (POWERMITE™)

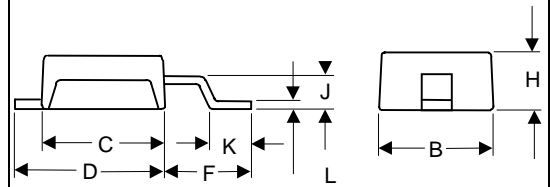
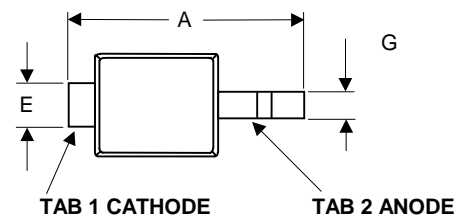

### Electrical Characteristics @ 25°C Unless Otherwise Specified

Average Forward Current	$I_{F(AV)}$	1.0A	$T_J = 100^\circ\text{C}$
Peak Forward Surge Current	$I_{FSM}$	50A	8.3ms, half sine
Maximum Instantaneous Forward Voltage UPS5817 UPS5818-5819	$V_F$	.45 V .55 V	$I_{FM} = 1.0\text{A};$ $T_J = 25^\circ\text{C}^*$
Maximum DC Reverse Current At Rated DC Blocking Voltage	$I_R$	1.0mA 5 mA	$T_J = 25^\circ\text{C}$ $T_J = 125^\circ\text{C}$
Typical Junction Capacitance	$C_J$	150pF	Measured at 1.0MHz, $V_R=4.0\text{V}$

\*Pulse test: Pulse width 200  $\mu\text{sec}$ , Duty cycle 2%

DIM	DIMENSIONS				NOTE
	INCHES		MM		
A	.143	.153	3.63	3.89	
B	.070	.080	1.78	2.03	
C	.070	.080	1.78	2.03	
D	.087	.097	2.21	2.46	
E	.029	.039	0.74	0.99	
F	.051	.061	1.30	1.55	
G	----	.026	----	0.66	
H	.035	.045	0.89	1.14	
J	.021	.031	0.53	0.79	
K	----	.025	----	0.64	
L	----	.006	----	0.15	

NOTE: POWERMITE™ package is patental by microsemi corp.

Figure 1  
Typical Forward Characteristics

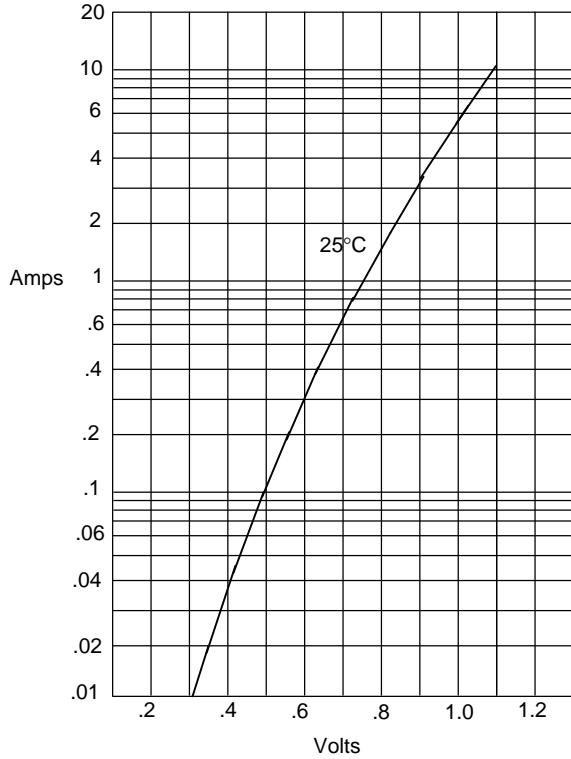

Instantaneous Forward Current - Amperes versus Instantaneous Forward Voltage - Volts

Figure 2  
Forward Derating Curve

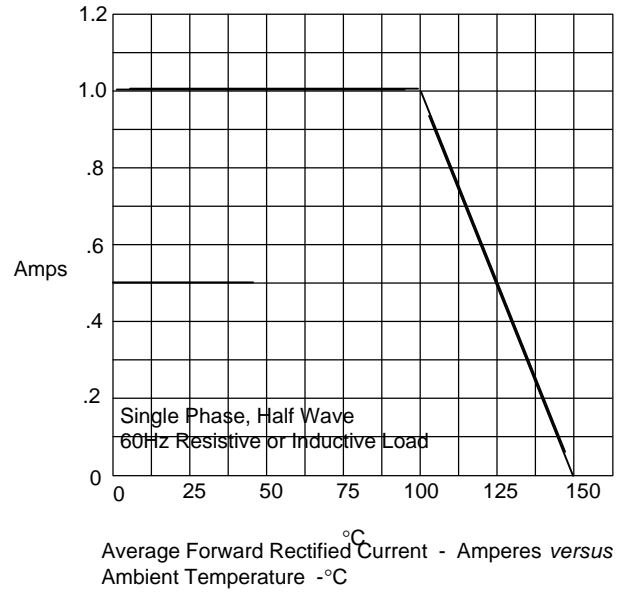

Average Forward Rectified Current - Amperes versus Ambient Temperature - °C

Figure 3  
Junction Capacitance

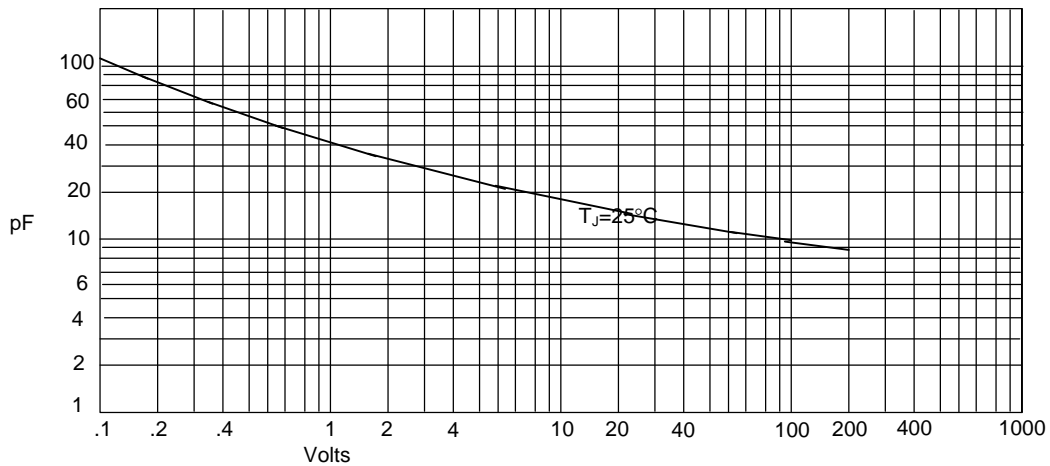

Junction Capacitance - pF versus Reverse Voltage - Volts

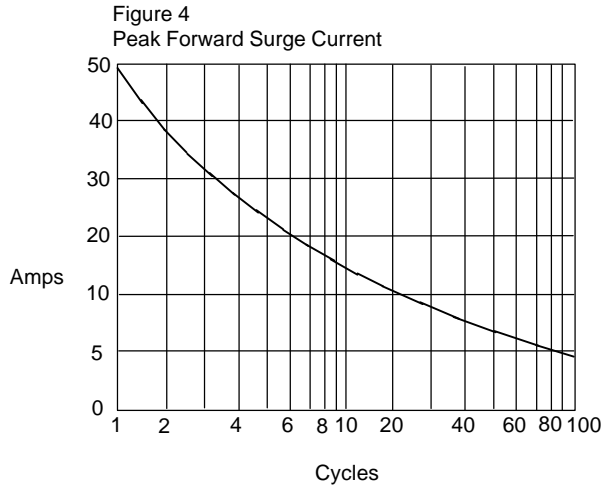

Peak Forward Surge Current - Amperes *versus* Number Of Cycles At 60Hz - Cycles

Figure 6  
Reverse Recovery Time Characteristic And Test Circuit Diagram

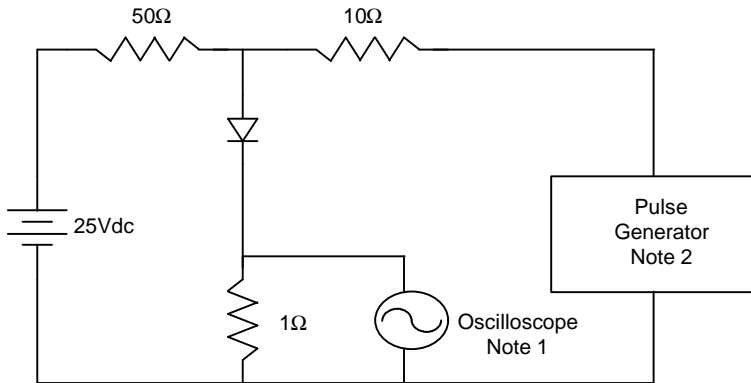

Notes:

1. Rise Time = 7ns max.  
Input impedance = 1 megohm, 22pF
2. Rise Time = 10ns max.  
Source impedance = 50 ohms
3. Resistors are non-inductive

