



Micro Commercial Components
 21201 Itasca Street Chatsworth
 CA 91311
 Phone: (818) 701-4933
 Fax: (818) 701-4939

MBR3020 THRU MBR30100

Features

- Metal of siliconrectifier, majonty carrier conducton
- Guard ring for transient protection
- Low power loss high efficiency
- High surge capacity, High current capability

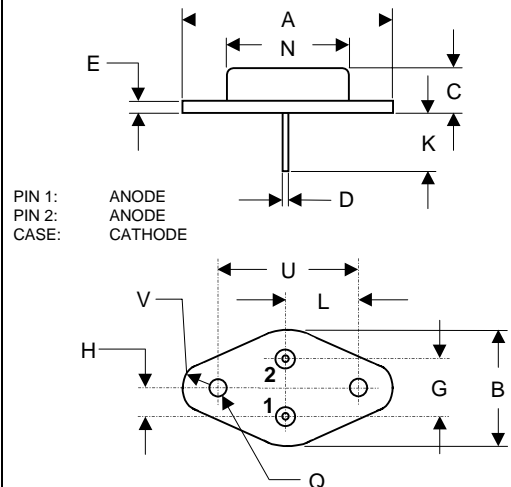
30 Amp Schottky Barrier Rectifier 20 to 100 Volts

Maximum Ratings

- Operating Temperature: -55°C to +150°C
- Storage Temperature: -55°C to +150°C

MCC Part Number	Maximum Recurrent Peak Reverse Voltage	Maximum RMS Voltage	Maximum DC Blocking Voltage
MBR3020	20V	14V	20V
MBR3030	30V	21V	30V
MBR3035	35V	24.5V	35V
MBR3040	40V	28V	40V
MBR3045	45V	31.5V	45V
MBR3060	60V	42V	60V
MBR3080	80V	56V	80V
MBR30100	100V	70V	100V

TO-3



Electrical Characteristics @ 25°C Unless Otherwise Specified

Average Forward Current	$I_{F(AV)}$	30 A	$T_L = 105^\circ\text{C}$
Peak Forward Surge Current	I_{FSM}	400A	8.3ms, half sine
Maximum Instantaneous Forward Voltage	V_F		$I_{FM} = 30.0\text{A};$ $T_A = 25^\circ\text{C}$
MBR3020-3045		.63 V	
MBR3060		.75 V	
MBR3080-30100		.84 V	
Maximum DC Reverse Current At Rated DC Blocking Voltage	I_R	1.0mA	$T_A = 25^\circ\text{C}$
Typical Junction Capacitance	C_J	200pF	Measured at 1.0MHz, $V_R=4.0\text{V}$

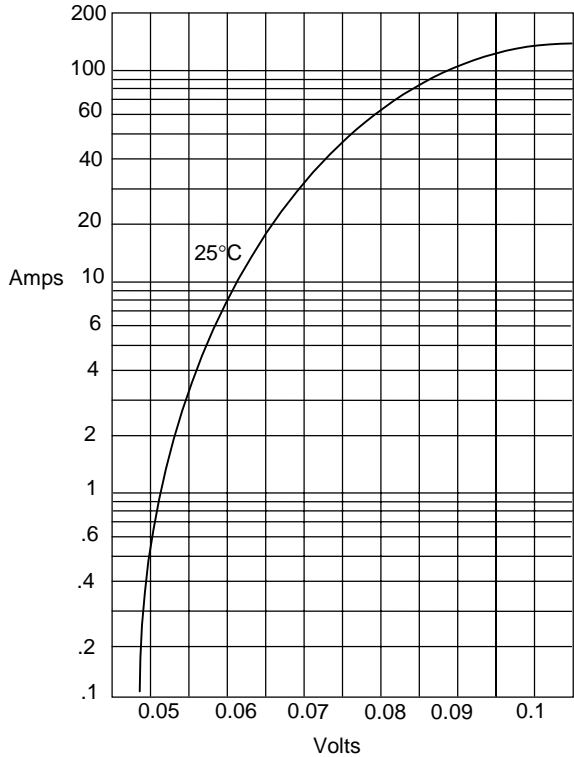
DIM	INCHES		MM	
	MIN	MAX	MIN	MAX
A	1.550	REF	39.37	REF
B	----	1.050	----	26.67
C	.250	.335	6.35	8.51
D	.038	.043	0.97	1.09
E	.055	.070	1.40	1.77
G	.430	BSC	10.92	BSC
H	.215	BSC	5.46	BSC
K	.440	.480	11.18	12.19
L	.665	BSC	16.89	BSC
N	----	.830	----	21.08
Q	.151	.165	3.84	4.19
U	1.187	BSC	30.15	BSC
V	.131	1.88	3.33	4.77

*Pulse Test: Pulse Width 300µsec, Duty Cycle 1%

MBR3020 thru MBR30100

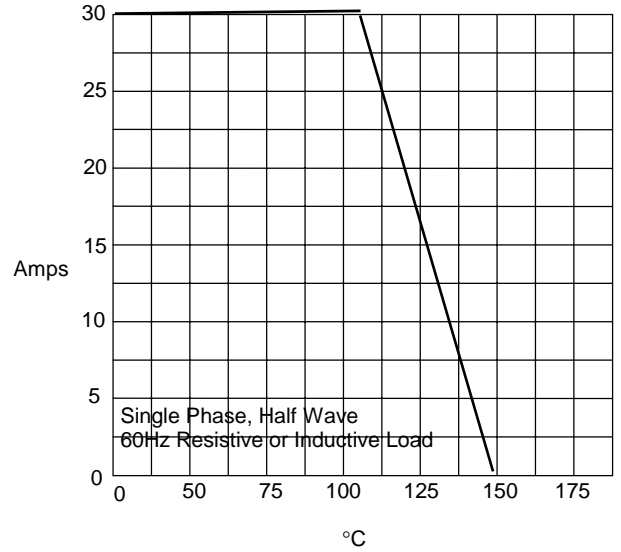


Figure 1
Typical Forward Characteristics



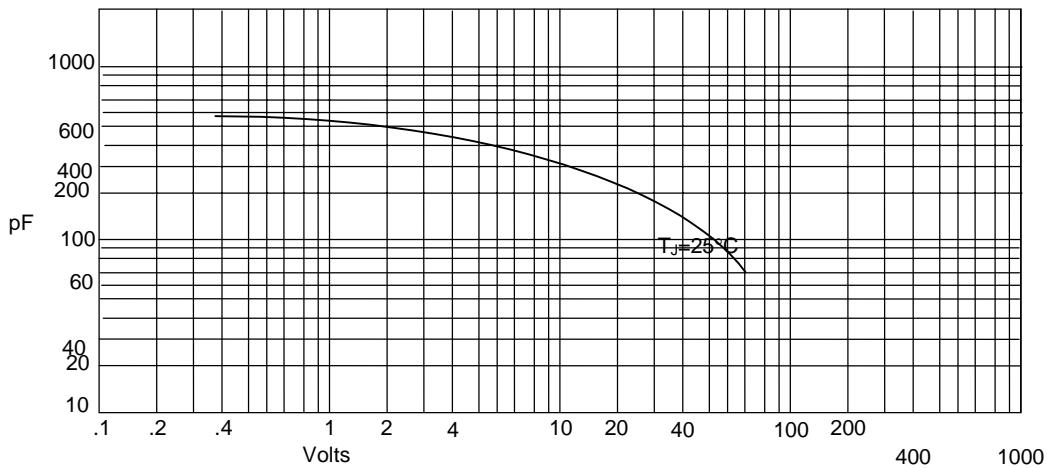
Instantaneous Forward Current - Amperes versus
Instantaneous Forward Voltage - Volts

Figure 2
Forward Derating Curve



Average Forward Rectified Current - Amperes versus
Ambient Temperature - °C

Figure 3
Junction Capacitance



Junction Capacitance - pF versus
Reverse Voltage - Volts

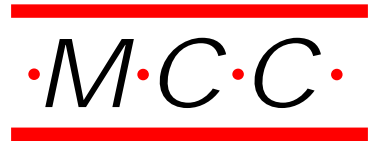
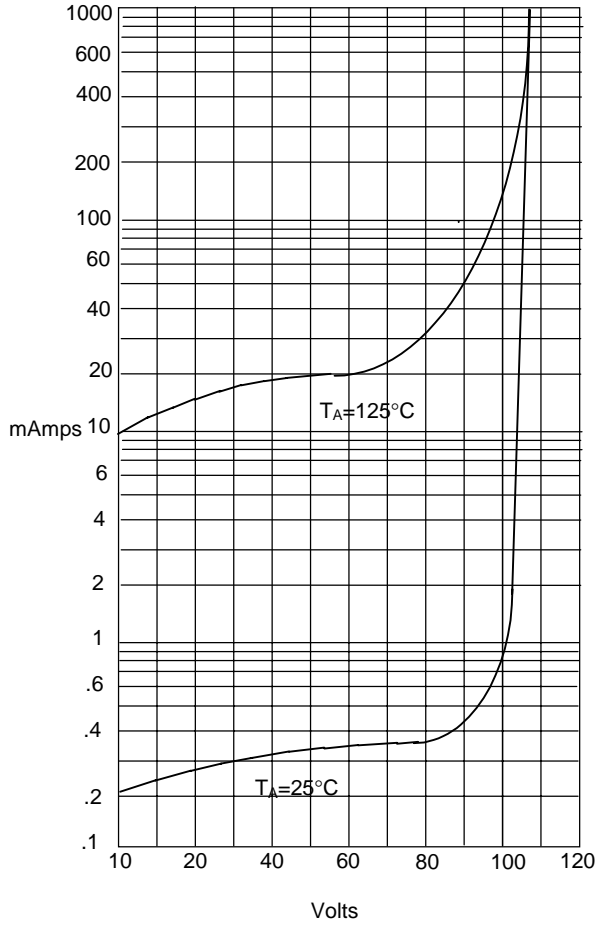
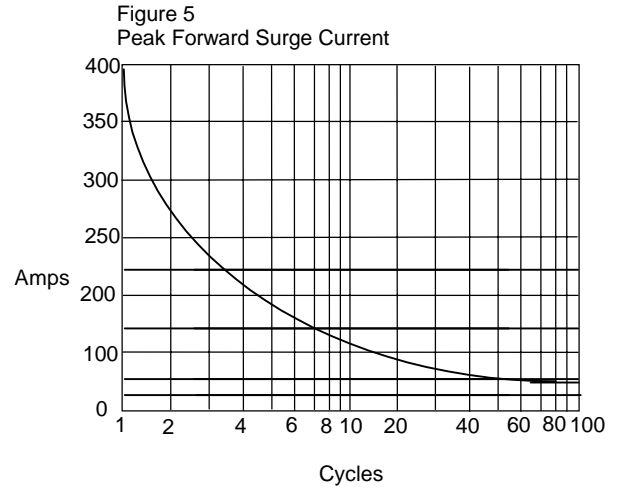


Figure 4
Typical Reverse Characteristics



Instantaneous Reverse Leakage Current - MicroAmperes *versus*
Percent Of Rated Peak Reverse Voltage - Volts



Peak Forward Surge Current - Amperes *versus*
Number Of Cycles At 60Hz - Cycles