



Low Cost Six-Way SMT Power Divider 824 - 960 MHz

Features

- Small Size, Low Profile
- Superior Repeatability (Lot-to-lot Variation)
- Industry Standard SOIC-16 SMT Plastic Package
- Typical Isolation 25dB
- Typical Insertion Loss 0.8dB
- Low Cost

Description

M/A-COM's DS56-0005 is an IC-based monolithic power divider in a low cost SOIC-16 plastic package. This 6-way power divider is ideally suited for applications where PCB real estate is at a premium and part count reduction and cost are critical. Typical applications include base station switching networks and other cellular equipment, including subscriber units. Available in Tape and Reel.

The DS56-0005 is fabricated using a passive-integrated circuit process. The process features full-chip passivation for increased performance and reliability.

SOIC-16

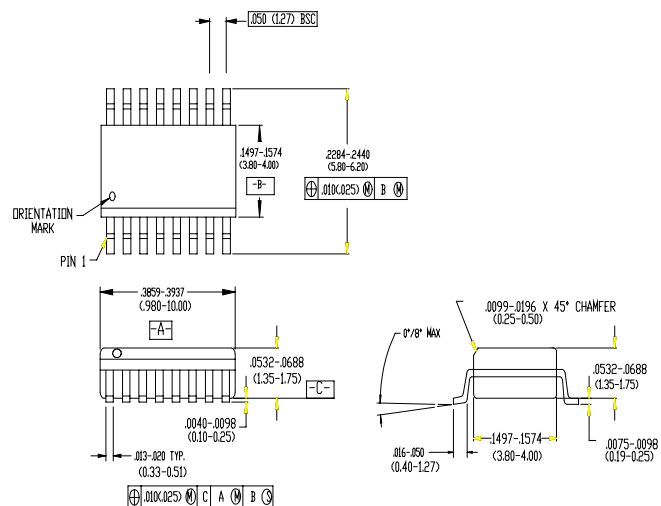

Ordering Information

Part Number	Package
DS56-0005	SOIC-16 Lead Plastic Package
DS56-0005-TR	Forward Tape and Reel ¹
DS56-0005-RTR	Reverse Tape and Reel ¹

1. If specific reel size is required, consult factory for part number assignment.

Typical Electrical Specifications¹, T_A = +25°C

Parameter	Units	Min	Typ	Max
Insertion Loss above 7.8dB	dB	—	0.8	1.2
Isolation	dB	20	25	—
VSWR Input	—	—	1.4 : 1	1.8 : 1
Output	—	—	1.3 : 1	1.5 : 1
Amplitude Balance	dB	—	0.5	0.9
Phase Balance	°	—	4	8

1. All specifications apply with a 50-Ohm source and load impedance.

Specifications subject to change without notice.

- North America: Tel. (800) 366-2266, Fax (800) 618-8883
- Asia/Pacific: Tel.+81-44-844-8296, Fax +81-44-844-8298
- Europe: Tel. +44 (1344) 869 595, Fax+44 (1344) 300 020

Visit www.macom.com for additional data sheets and product information.

tyco / Electronics



Absolute Maximum Ratings¹

Parameter	Absolute Maximum
Input Power ²	1 W CW
Operating Temperature	-40°C to +85°C
Storage Temperature	-65°C to +150°C

1. Exceeding these limits may cause permanent damage.
2. With internal load dissipation of 0.125 W Maximum.

Functional Diagram

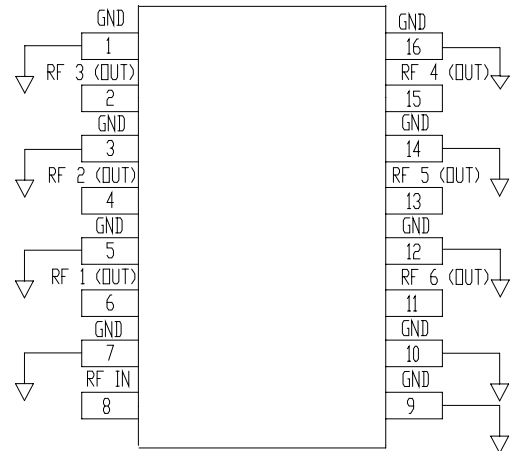

Typical Performance @ +25°C

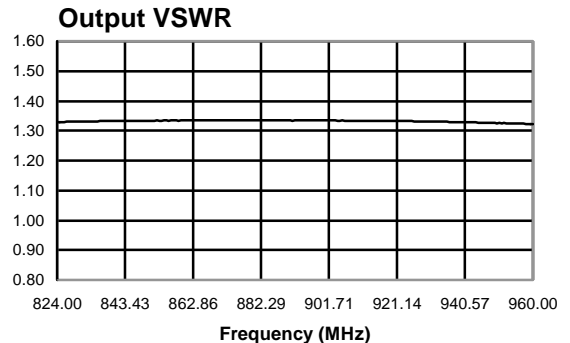
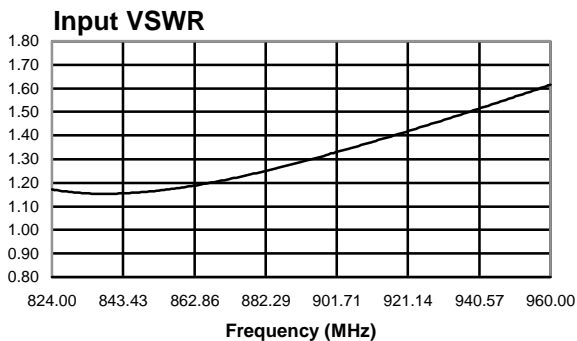
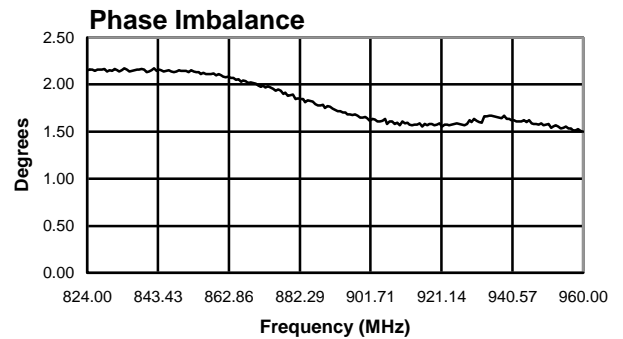
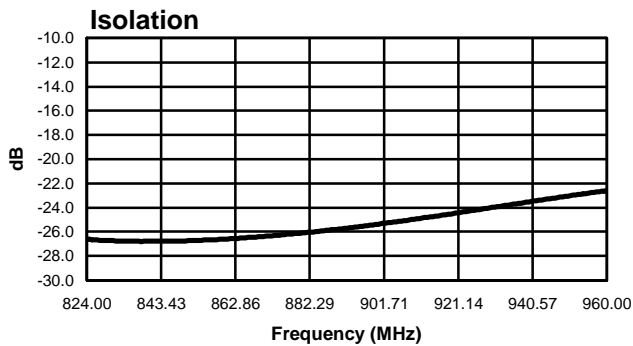
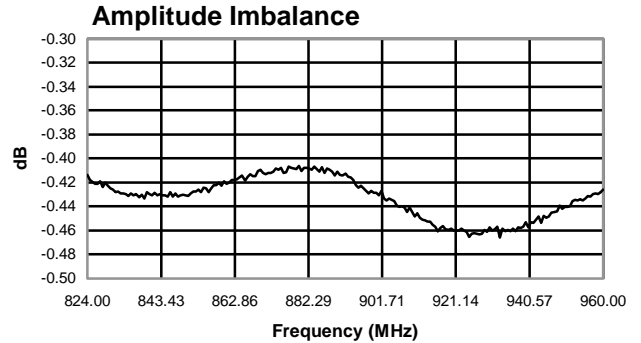
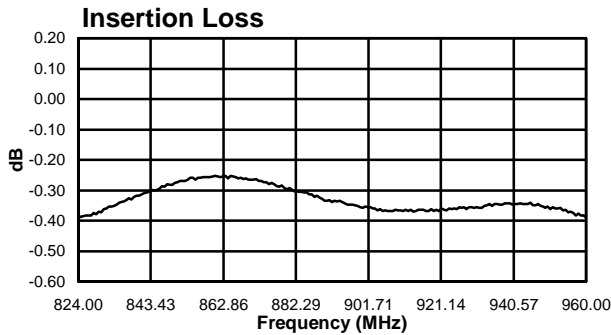

Specifications subject to change without notice.

- North America: Tel. (800) 366-2266, Fax (800) 618-8883
- Asia/Pacific: Tel.+81-44-844-8296, Fax +81-44-844-8298
- Europe: Tel. +44 (1344) 869 595, Fax+44 (1344) 300 020

Visit www.macom.com for additional data sheets and product information.