

Bias Resistor Transistor

NPN Silicon Surface Mount Transistor with Monolithic Bias Resistor Network

This new series of digital transistors is designed to replace a single device and its external resistor bias network. The BRT (Bias Resistor Transistor) contains a single transistor with a monolithic bias network consisting of two resistors; a series base resistor and a base-emitter resistor. The BRT eliminates these individual components by integrating them into a single device. The use of a BRT can reduce both system cost and board space. The device is housed in the SC-70/SOT-323 package which is designed for low power surface mount applications.

- Simplifies Circuit Design
- Reduces Board Space
- Reduces Component Count
- The SC-70/SOT-323 package can be soldered using wave or reflow. The modified gull-winged leads absorb thermal stress during soldering eliminating the possibility of damage to the die.
- Available in 8 mm embossed tape and reel
Use the Device Number to order the 7 inch/3000 unit reel.
- Pb-Free package is available

DEVICE MARKING INFORMATION

See specific marking information in the device marking table on page 2 of this data sheet.

MAXIMUM RATINGS ($T_A = 25^\circ\text{C}$ unless otherwise noted)

Rating	Symbol	Value	Unit
Collector-Base Voltage	V_{CBO}	50	Vdc
Collector-Emitter Voltage	V_{CEO}	50	Vdc
Collector Current	I_C	100	mAdc

THERMAL CHARACTERISTICS

Characteristic	Symbol	Max	Unit
Total Device Dissipation $T_A = 25^\circ\text{C}$ Derate above 25°C	P_D	202 (Note 1.) 310 (Note 2.) 1.6 (Note 1.) 2.5 (Note 2.)	mW mW/ $^\circ\text{C}$
Thermal Resistance – Junction-to-Ambient	$R_{\theta JA}$	618 (Note 1.) 403 (Note 2.)	$^\circ\text{C}/\text{W}$
Thermal Resistance – Junction-to-Lead	$R_{\theta JL}$	280 (Note 1.) 332 (Note 2.)	$^\circ\text{C}/\text{W}$
Junction and Storage Temperature Range	T_J, T_{stg}	-55 to +150	$^\circ\text{C}$

1. FR-4 @ Minimum Pad
2. FR-4 @ 1.0 x 1.0 inch Pad

LMUN5211T1 SERIES



SC-70 / SOT-323

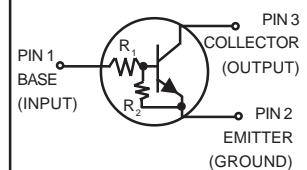

MARKING DIAGRAM

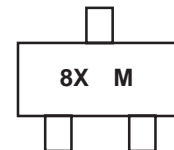

8x = Specific Device Code
x = (See Marking Table)
M = Date Code

LMUN5211T1 Series

DEVICE MARKING RESISTOR VALUES AND ORDERING INFORMATION

Device	Package	Marking	R1(K)	R2(K)	Shipping
LMUN5211T1	SC-70/SOT-323	8A	10	10	3000/Tape&Reel
LMUN5211T1G	SC-70/SOT-323	8A(Pb-Free)	10	10	3000/Tape&Reel
LMUN5212T1	SC-70/SOT-323	8B	22	22	3000/Tape&Reel
LMUN5212T1G	SC-70/SOT-323	8B(Pb-Free)	22	22	3000/Tape&Reel
LMUN5213T1	SC-70/SOT-323	8C	47	47	3000/Tape&Reel
LMUN5213T1G	SC-70/SOT-323	8C(Pb-Free)	47	47	3000/Tape&Reel
LMUN5214T1	SC-70/SOT-323	8D	10	47	3000/Tape&Reel
LMUN5214T1G	SC-70/SOT-323	8D(Pb-Free)	10	47	3000/Tape&Reel
LMUN5215T1(Note 3)	SC-70/SOT-323	8E	10	∞	3000/Tape&Reel
LMUN5215T1G	SC-70/SOT-323	8E(Pb-Free)	10	∞	3000/Tape&Reel
LMUN5216T1(Note 3)	SC-70/SOT-323	8F	4.7	∞	3000/Tape&Reel
LMUN5216T1G	SC-70/SOT-323	8F(Pb-Free)	4.7	∞	3000/Tape&Reel
LMUN5230T1(Note 3)	SC-70/SOT-323	8G	1	1	3000/Tape&Reel
LMUN5230T1G	SC-70/SOT-323	8G(Pb-Free)	1	1	3000/Tape&Reel
LMUN5231T1(Note 3)	SC-70/SOT-323	8H	2.2	2.2	3000/Tape&Reel
LMUN5231T1G	SC-70/SOT-323	8H(Pb-Free)	2.2	2.2	3000/Tape&Reel
LMUN5232T1(Note 3)	SC-70/SOT-323	8J	4.7	4.7	3000/Tape&Reel
LMUN5232T1G	SC-70/SOT-323	8J(Pb-Free)	4.7	4.7	3000/Tape&Reel
LMUN5233T1(Note 3)	SC-70/SOT-323	8K	4.7	47	3000/Tape&Reel
LMUN5233T1G	SC-70/SOT-323	8K(Pb-Free)	4.7	47	3000/Tape&Reel
LMUN5234T1(Note 3)	SC-70/SOT-323	8L	22	47	3000/Tape&Reel
LMUN5234T1G	SC-70/SOT-323	8L(Pb-Free)	22	47	3000/Tape&Reel
LMUN5235T1(Note 3)	SC-70/SOT-323	8M	2.2	47	3000/Tape&Reel
LMUN5235T1G	SC-70/SOT-323	8M(Pb-Free)	2.2	47	3000/Tape&Reel
LMUN5236T1(Note 3)	SC-70/SOT-323	8N	100	100	3000/Tape&Reel
LMUN5236T1G	SC-70/SOT-323	8N(Pb-Free)	100	100	3000/Tape&Reel
LMUN5237T1(Note 3)	SC-70/SOT-323	8P	47	22	3000/Tape&Reel
LMUN5237T1G	SC-70/SOT-323	8P(Pb-Free)	47	22	3000/Tape&Reel

3. New devices. Updated curves to follow in subsequent data sheets.

LMUN5211T1 Series

ELECTRICAL CHARACTERISTICS ($T_A = 25^\circ\text{C}$ unless otherwise noted) (Continued)

Characteristic	Symbol	Min	Typ	Max	Unit
ON CHARACTERISTICS (Note 5.) (Continued)					
Output Voltage (off) ($V_{CC} = 5.0\text{ V}$, $V_B = 0.5\text{ V}$, $R_L = 1.0\text{ k}\Omega$) ($V_{CC} = 5.0\text{ V}$, $V_B = 0.050\text{ V}$, $R_L = 1.0\text{ k}\Omega$) ($V_{CC} = 5.0\text{ V}$, $V_B = 0.25\text{ V}$, $R_L = 1.0\text{ k}\Omega$) LMUN5230T1 LMUN5215T1 LMUN5216T1 LMUN5233T1	V_{OH}	4.9	–	–	Vdc
Input Resistor LMUN5211T1 LMUN5212T1 LMUN5213T1 LMUN5214T1 LMUN5215T1 LMUN5216T1 LMUN5230T1 LMUN5231T1 LMUN5232T1 LMUN5233T1 LMUN5234T1 LMUN5235T1 LMUN5236T1 LMUN5237T1	R_1	7.0 15.4 32.9 7.0 7.0 3.3 0.7 1.5 3.3 3.3 15.4 1.54 70 32.9	10 22 47 10 10 4.7 1.0 2.2 4.7 4.7 22 2.2 100 47	13 28.6 61.1 13 13 6.1 1.3 2.9 6.1 6.1 28.6 2.86 130 61.1	$\text{k}\Omega$
Resistor Rati LMUN5211T1/LMUN5212T1/LMUN5213T1/ LMUN5236T1 LMUN5214T1 LMUN5215T1/LMUN5216T1 LMUN5230T1/LMUN5231T1/LMUN5232T1 LMUN5233T1 LMUN5234T1 LMUN5235T1 LMUN5237T1	R_1/R_2	0.8 0.17 – 0.8 0.055 0.38 0.038 1.7	1.0 0.21 – 1.0 0.1 0.47 0.047 2.1	1.2 0.25 – 1.2 0.185 0.56 0.056 2.6	

5. Pulse Test: Pulse Width < 300 μs , Duty Cycle < 2.0%

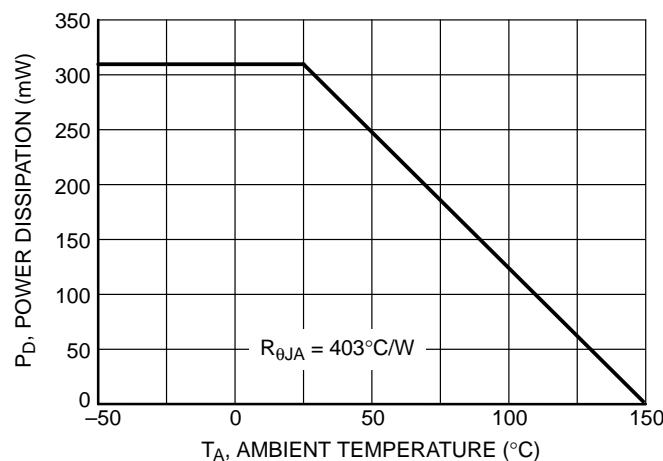

Figure 1. Derating Curve

LMUN5211T1 Series

TYPICAL ELECTRICAL CHARACTERISTICS – LMUN5211T1

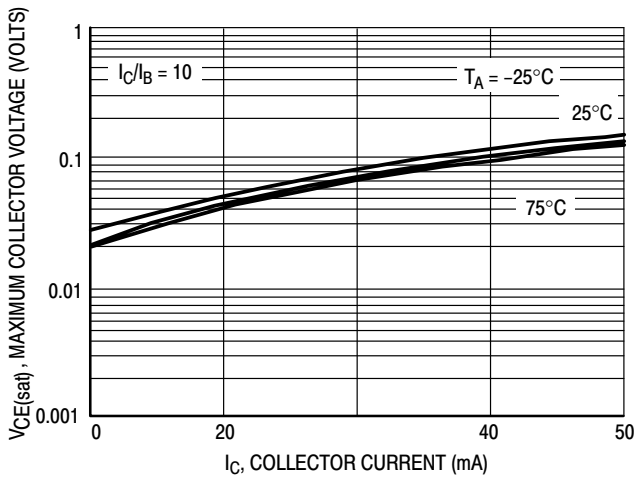

Figure 2. $V_{CE(sat)}$ versus I_C

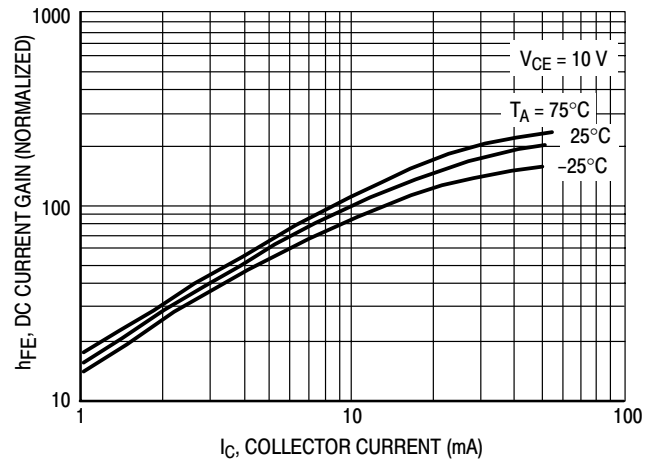

Figure 3. DC Current Gain

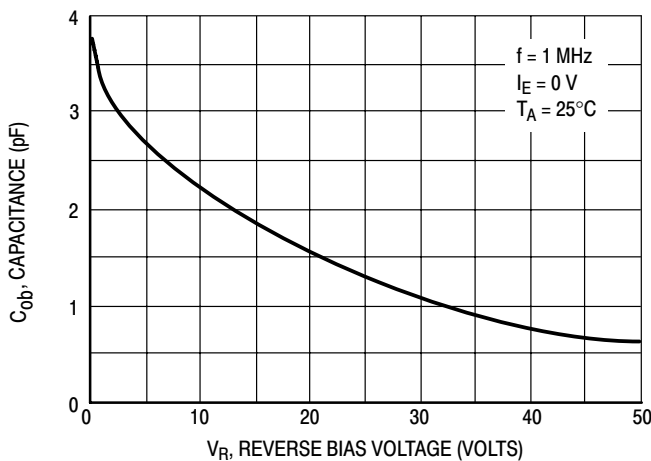

Figure 4. Output Capacitance

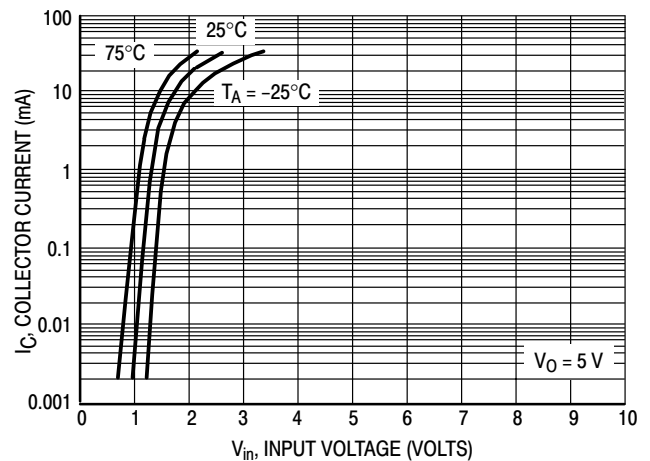

Figure 5. Output Current versus Input Voltage

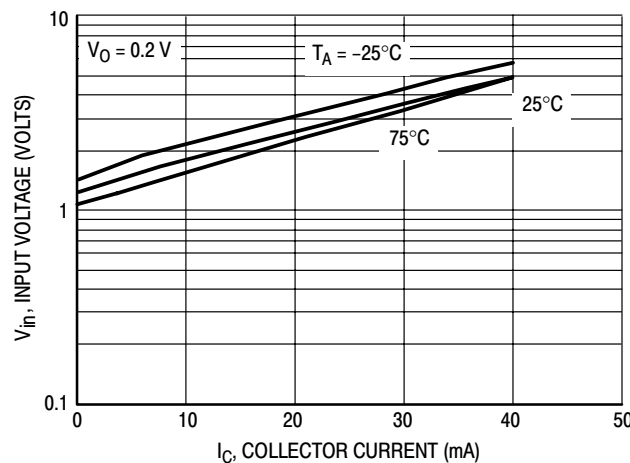

Figure 6. Input Voltage versus Output Current

LMUN5211T1 Series

TYPICAL ELECTRICAL CHARACTERISTICS – LMUN5212T1

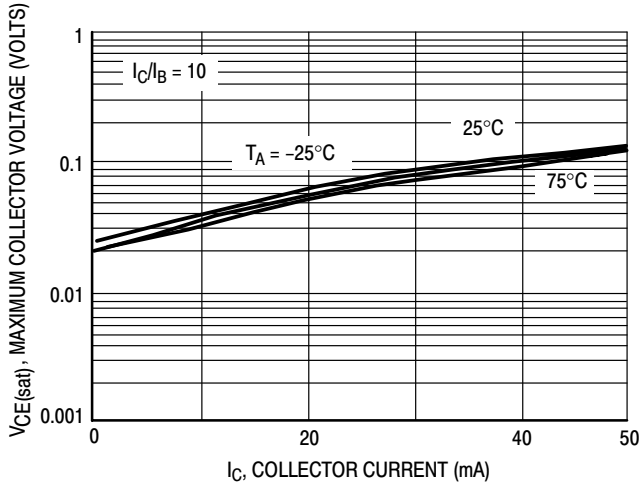

Figure 7. $V_{CE(sat)}$ versus I_C

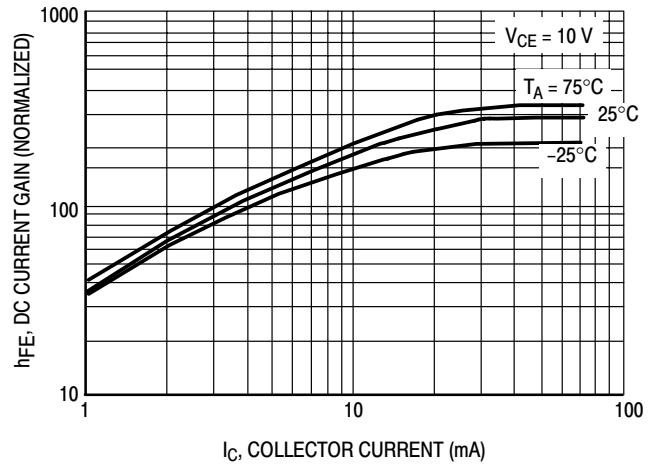

Figure 8. DC Current Gain

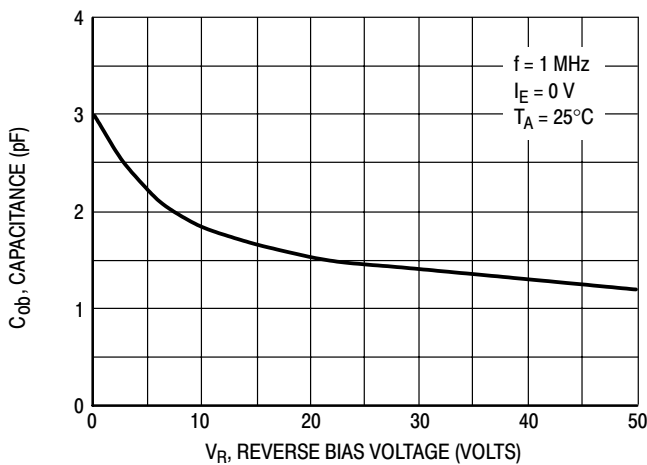

Figure 9. Output Capacitance

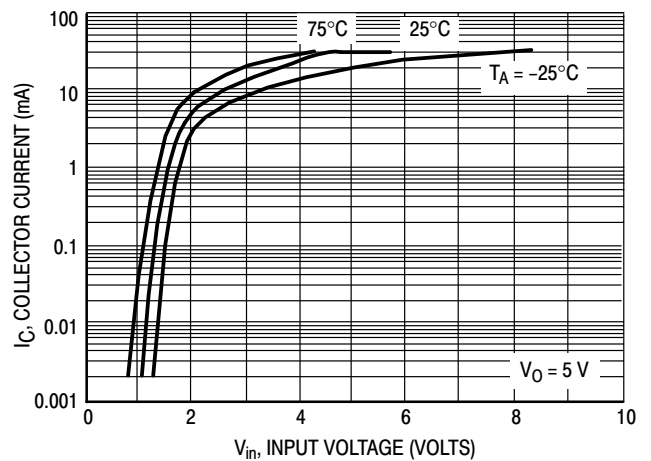

Figure 10. Output Current versus Input Voltage

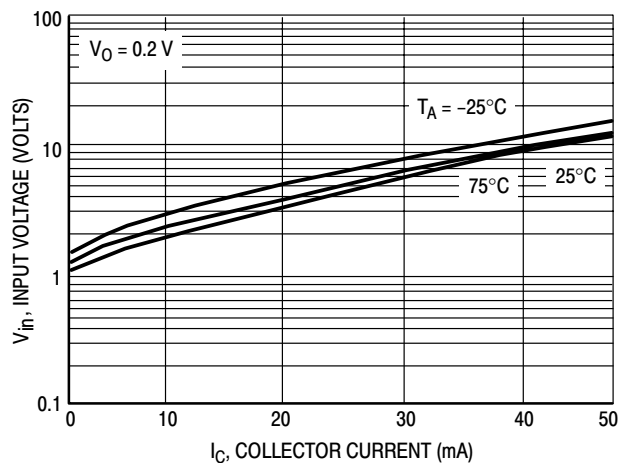

Figure 11. Input Voltage versus Output Current

LMUN5211T1 Series

TYPICAL ELECTRICAL CHARACTERISTICS – LMUN5213T1

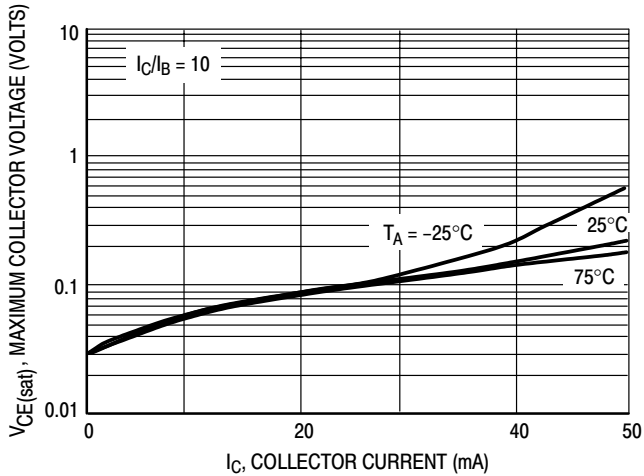

Figure 12. $V_{CE(sat)}$ versus I_C

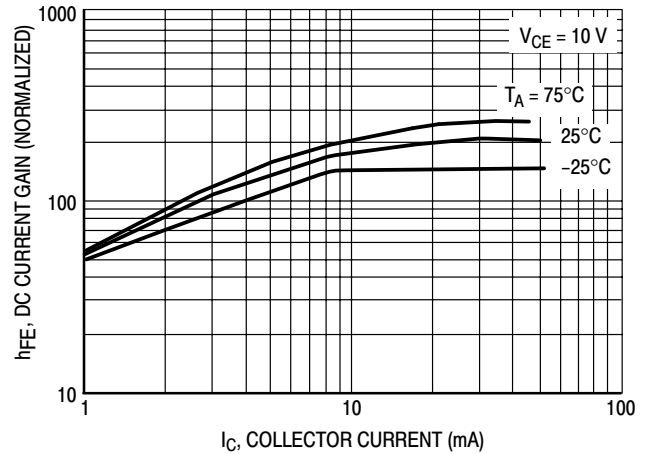

Figure 13. DC Current Gain

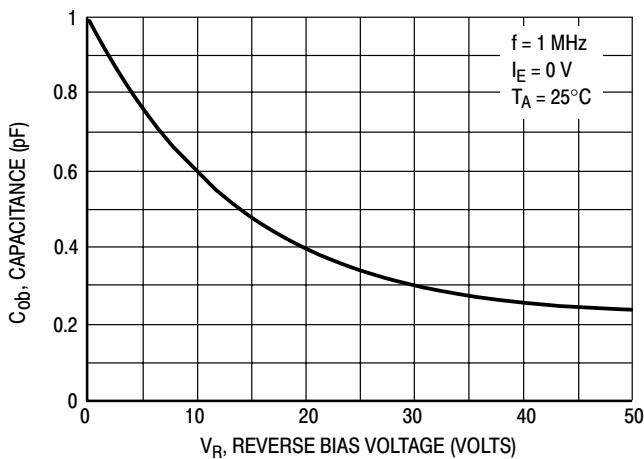

Figure 14. Output Capacitance

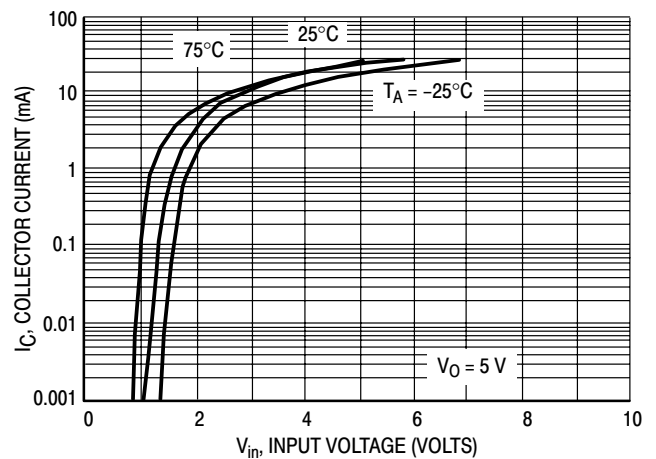

Figure 15. Output Current versus Input Voltage

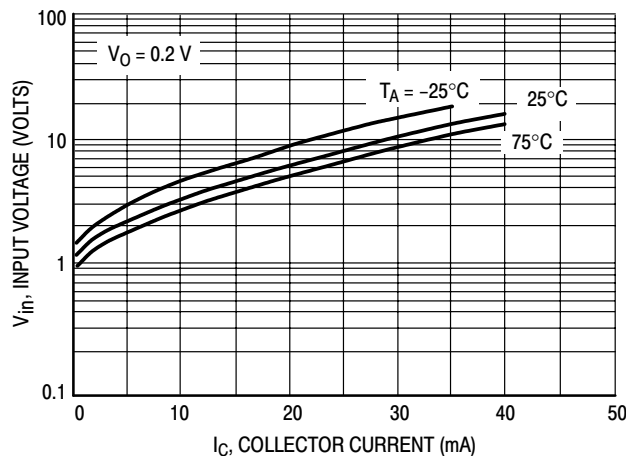

Figure 16. Input Voltage versus Output Current

LMUN5211T1 Series

TYPICAL ELECTRICAL CHARACTERISTICS – LMUN5214T1

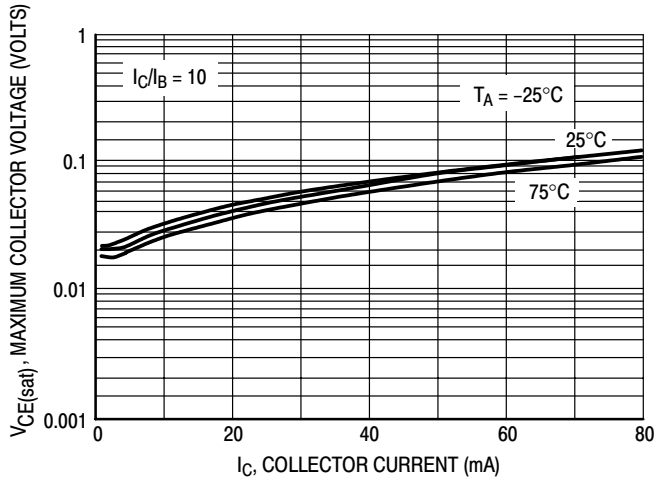

Figure 17. $V_{CE(sat)}$ versus I_C

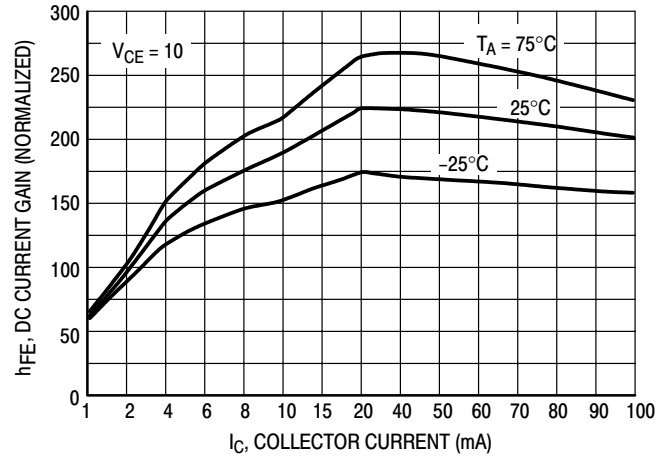

Figure 18. DC Current Gain

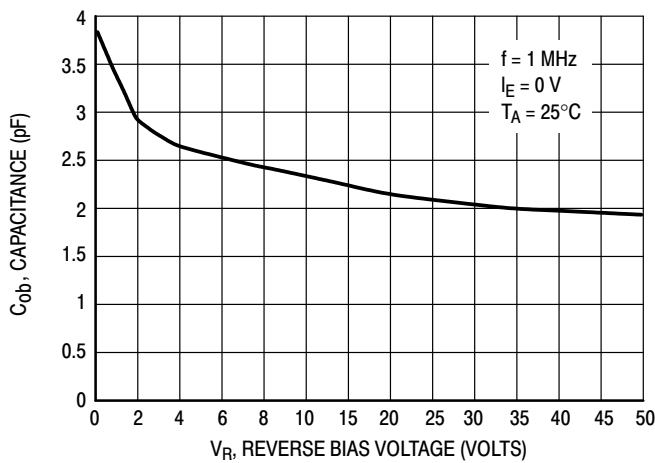

Figure 19. Output Capacitance

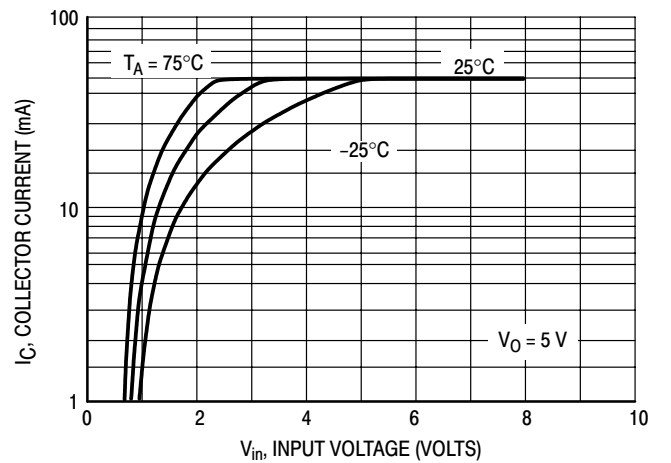

Figure 20. Output Current versus Input Voltage

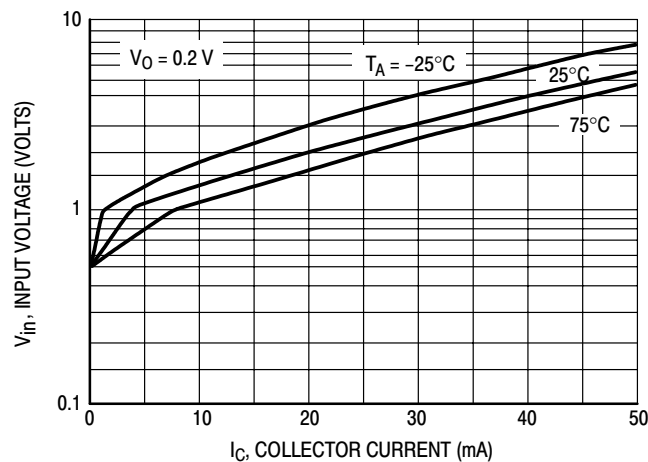

Figure 21. Input Voltage versus Output Current

LMUN5211T1 Series

TYPICAL APPLICATIONS FOR NPN BRTs

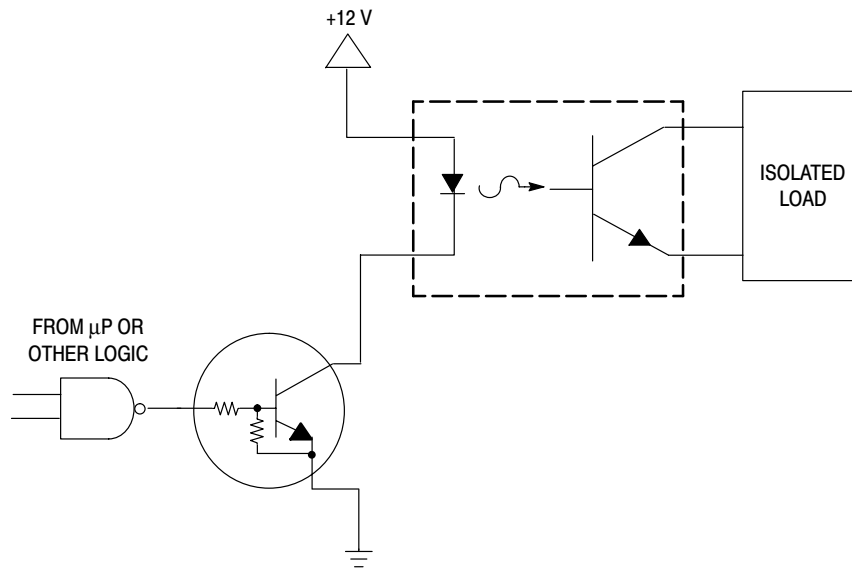

Figure 22. Level Shifter: Connects 12 or 24 Volt Circuits to Logic

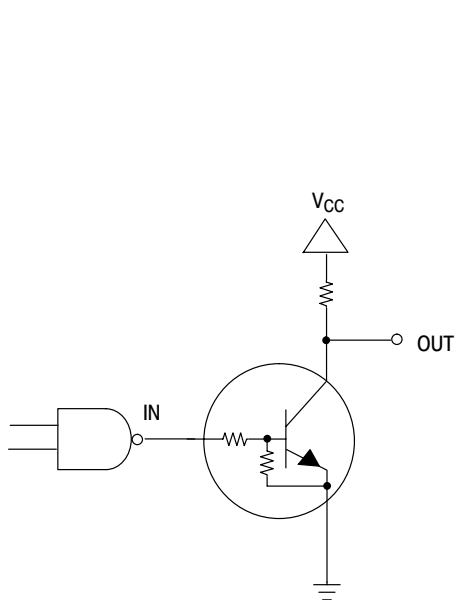

Figure 23. Open Collector Inverter: Inverts the Input Signal

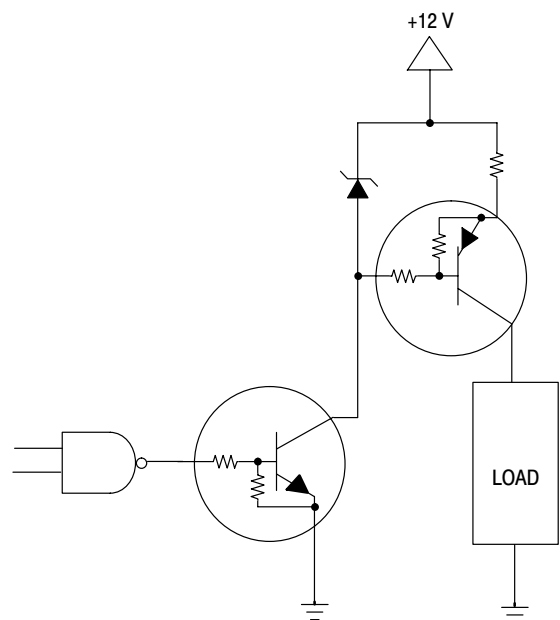

Figure 24. Inexpensive, Unregulated Current Source

LMUN5211T1 Series

SC-70 / SOT-323

NOTES:

1. DIMENSIONING AND TOLERANCING PER ANSI Y14.5M, 1982.
2. CONTROLLING DIMENSION: INCH.

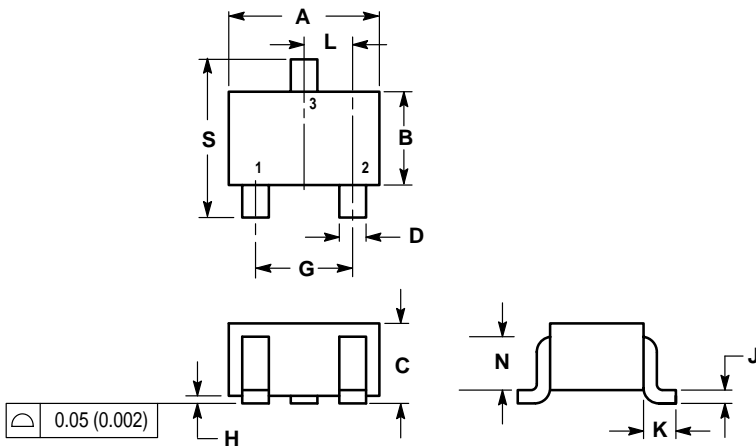

DIM	INCHES		MILLIMETERS	
	MIN	MAX	MIN	MAX
A	0.071	0.087	1.80	2.20
B	0.045	0.053	1.15	1.35
C	0.032	0.040	0.80	1.00
D	0.012	0.016	0.30	0.40
G	0.047	0.055	1.20	1.40
H	0.000	0.004	0.00	0.10
J	0.004	0.010	0.10	0.25
K	0.017 REF		0.425 REF	
L	0.026 BSC		0.650 BSC	
N	0.028 REF		0.700 REF	
S	0.079	0.095	2.00	2.40

- PIN 1. BASE
 2. EMITTER
 3. COLLECTOR

