

JWS-SERIES

Single output 50W ~ 600W

LAMBDA
DENSEI-LAMBDA

Unit Type Power Supply

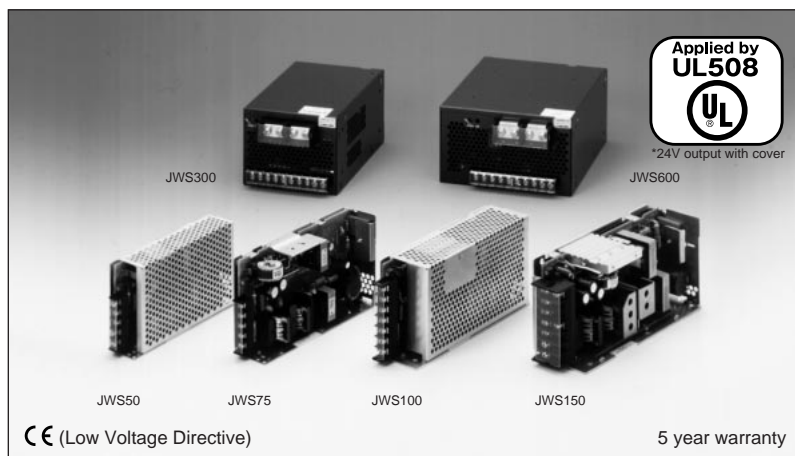

Model name

JWS 50-5/

Name of series

Nominal output voltage

Output power type

Blank: Open frame, Barrier Strip (JWS300, JWS600 with cover & Barrier Strip)

A: With cover, Barrier Strip (JWS50, JWS75, JWS100 & JWS150 only)

B: Open frame, Connector terminal (JWS50 & JWS75 only)

C: With cover, Connector terminal (JWS50 & JWS75 only)

R: With remote on/off control (JWS50 ~ JWS150: Optional) (JWS300, JWS600: Equipped as standard)

Features

- CE marking (Low Voltage Directive)
- Wide input voltage range: Universal input 85 ~ 265VAC
- PFHC (EN61000-3-2)
- EMI (EN55011-B, EN55022-B, VCCI-B, FCC-B)
- EMC (EN61000-4-2, -3, -4, -5, -6)
- 5 year warranty

Specifications

1. Input voltage range	85 ~ 265VAC (47 ~ 63Hz), DC120 ~ 330V universal input
2. Power factor	0.99 (typ) 100VAC at full load, 0.95 (typ) 200VAC at full load
3. Cooling	JWS50 ~ JWS150: Convection cooling / JWS300 & JWS600: Forced air cooling by internal fan
4. Operating ambient temperature	JWS50 ~ JWS150: -10 ~ +60°C (Standard mounting) Output derating: 100% at -10 ~ +50°C, 60% at +60°C JWS300 ~ JWS600: 100% at -10 ~ +50°C, 60% : +60°C, 55% at +65°C
5. Withstand voltage	Input-output: 3kVAC, Input-chassis : 2kVAC, Output-chassis: 500VAC for 1 min.
6. EMI	Conforms to EN55011-B, EN55022-B, VCCI-class 2 and FCC-B
7. EMS	Conforms to EN55011-B, EN55022-B, VCCI-class 2 and FCC-B
8. PFHC	Conforms to EN61000-3-2 class D
9. Safety standard	Approved by UL1950 , CSA950 , EN60950 , VDE0160 and UL508 (optional, Note)
10. Functions	Over voltage protection, Over current protection, Remote sensing (JWS100 ~ JWS600), Remote on/off control (JWS300 ~ 600)
11. Option	Remote on/off control, Input/output connector (JWS50, 75), Cover, Mounting sheet metal

Note: Approved by UL508 for 24V output type only.

Product lineup

Model name		Nominal output voltage	Max. output current	Max. output power	UL	CSA	EN
JWS50	JWS50-3	3.3V	10A	33W	○	○	○
	JWS50-5	5V	10A	50W	○	○	○
	JWS50-12	12V	4.3A	51.6W	○	○	○
	JWS50-15	15V	3.5A	52.5W	○	○	○
	JWS50-24	24V	2.2A	52.8W	○	○	○
JWS75	JWS75-3	3.3V	15A	49.5W	○	○	○
	JWS75-5	5V	15A	75W	○	○	○
	JWS75-12	12V	6.3A	75.6W	○	○	○
	JWS75-15	15V	5.0A	75W	○	○	○
	JWS75-24	24V	3.2A	76.8W	○	○	○
JWS100	JWS100-3	3.3V	20A	66W	○	○	○
	JWS100-5	5V	20A	100W	○	○	○
	JWS100-12	12V	8.5A	102W	○	○	○
	JWS100-15	15V	7.0A	105W	○	○	○
	JWS100-24	24V	4.5A	108W	○	○	○
JWS150	JWS150-3	3.3V	30A	99W	○	○	○
	JWS150-5	5V	30A	150W	○	○	○
	JWS150-12	12V	13A	156W	○	○	○
	JWS150-15	15V	10A	150W	○	○	○
	JWS150-24	24V	6.5A	156W	○	○	○
JWS300	JWS300-2	2V	60A	120W	○	○	○
	JWS300-3	3.3V	60A	198W	○	○	○
	JWS300-5	5V	60A	300W	○	○	○
	JWS300-12	12V	27A	324W	○	○	○
	JWS300-15	15V	22A	330W	○	○	○
JWS600	JWS600-2	2V	120A	240W	○	○	○
	JWS600-3	3.3V	120A	396W	○	○	○
	JWS600-5	5V	120A	600W	○	○	○
	JWS600-12	12V	53A	636W	○	○	○
	JWS600-15	15V	43A	645W	○	○	○
JWS600	JWS600-24	24V	27A	648W	○	○	○
	JWS600-48	48V	13A	624W	○	○	○

- Request customer specification for further details of specification, outline, characteristics, etc. Read the instruction manual before usage.
- Contact us about delivery before ordering.

○ : Safety standard approved

■ JWS50 (50W type)

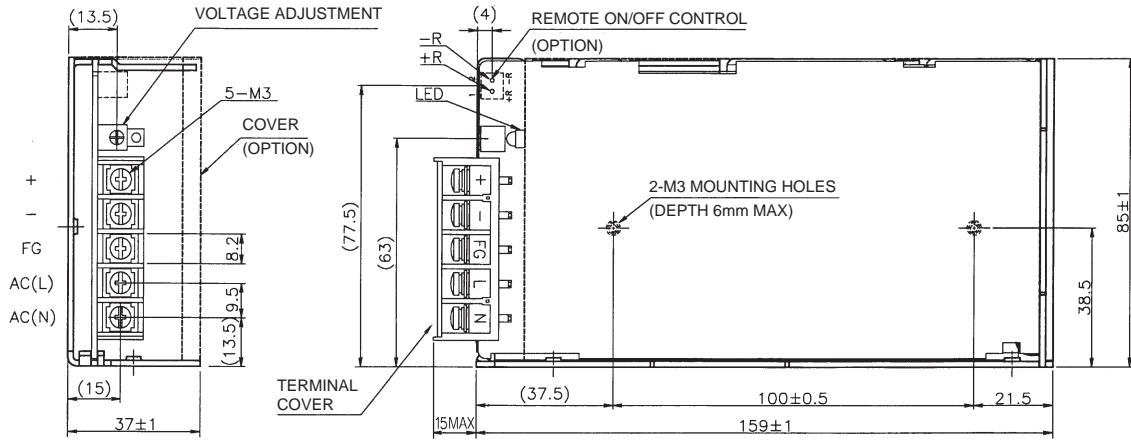

● Recommended Noise Filter



● Recommended Power Supply Fixture P198

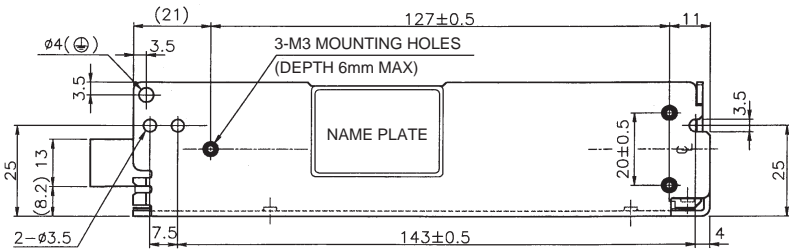

(Unit: mm)

■ JWS50 (50W connector type)

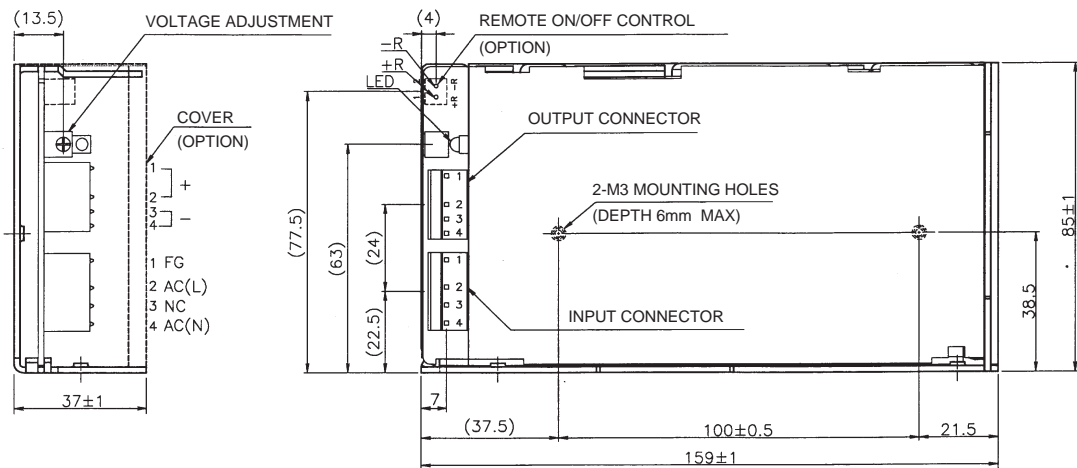

● Recommended Noise Filter



● Recommended Power Supply Fixture P198

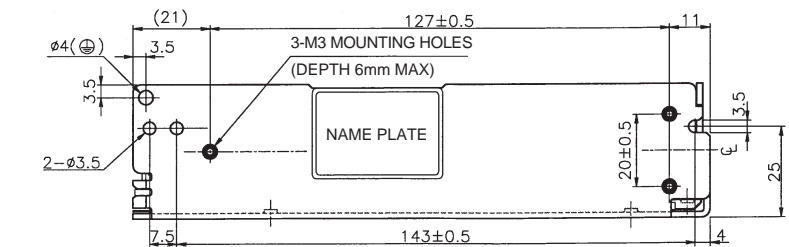

(Unit: mm)

■ JWS75 (75W type)

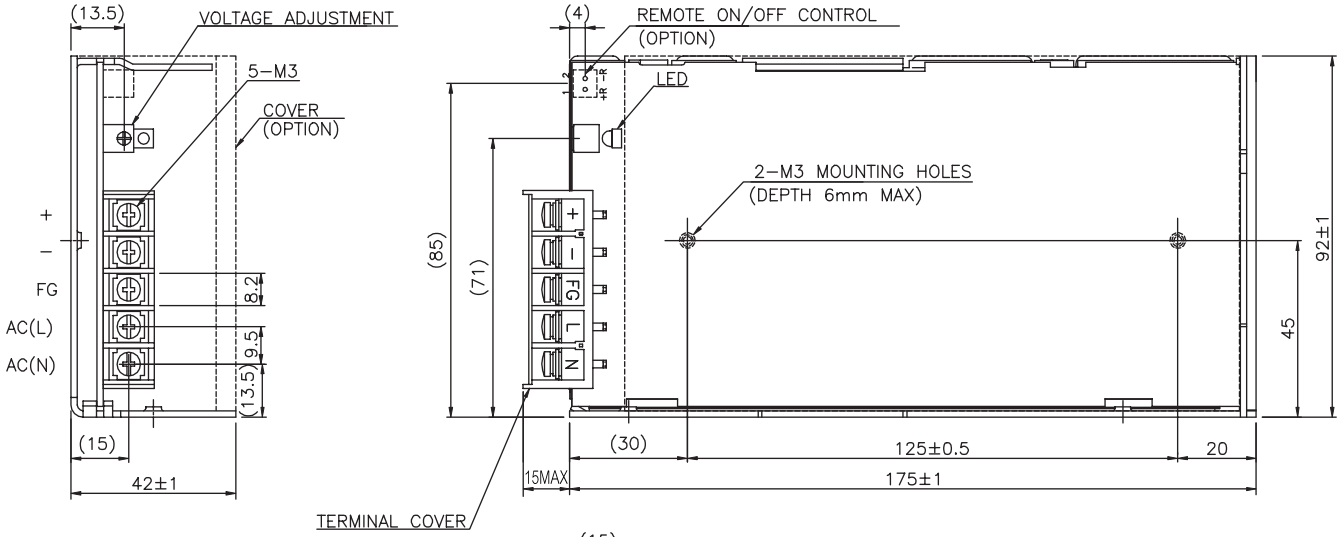

● Recommended Noise Filter

MAW-1202-22



P134

● Recommended Power Supply Fixture



P198

(Unit: mm)

■ JWS75 (75W connector type)

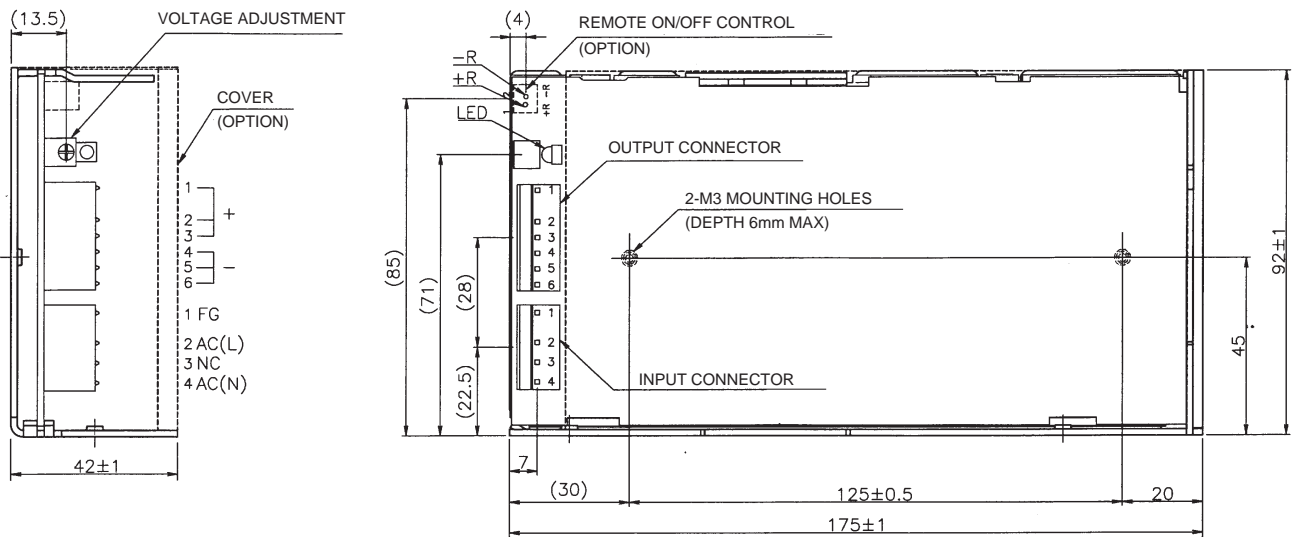

● Recommended Noise Filter

MAW-1202-22



P134

● Recommended Power Supply Fixture



P198

(Unit: mm)

JWS-SERIES

■ JWS100 (100W type)

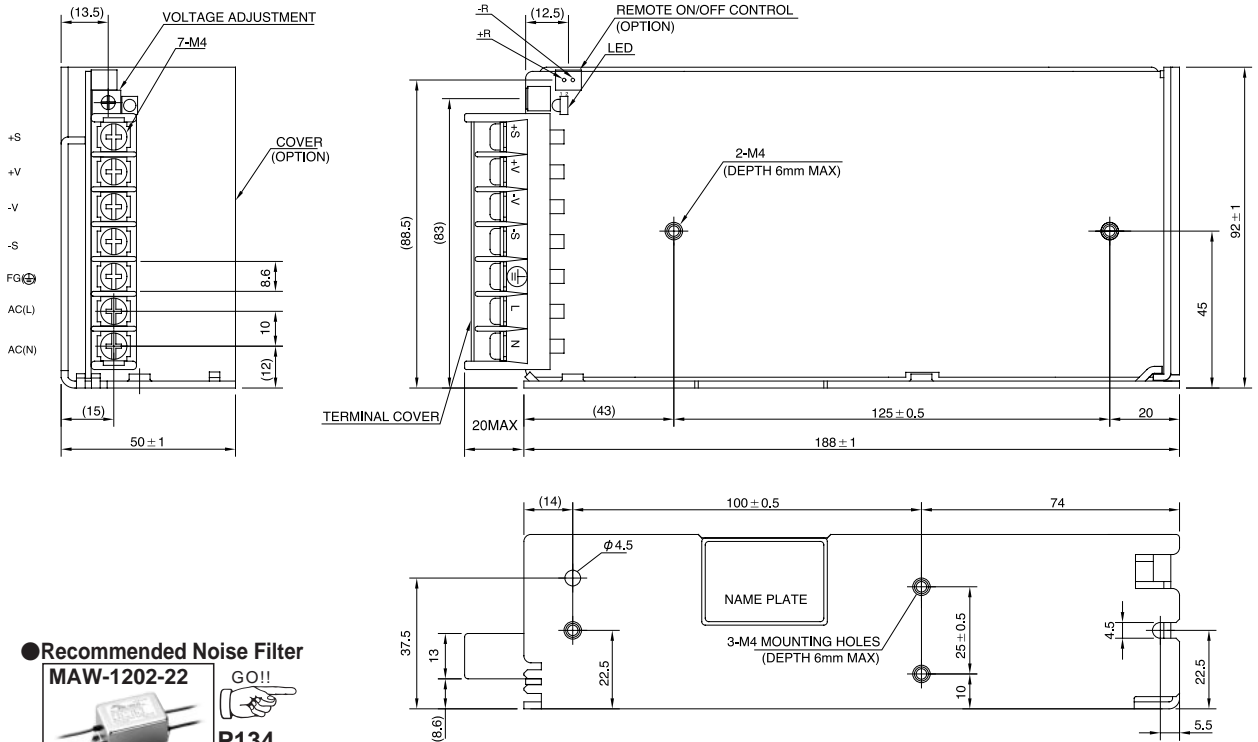

● Recommended Noise Filter
MAW-1202-22
GO!!
P134

● Recommended Power Supply Fixture P198

(Unit: mm)

■ JWS150 (150W)

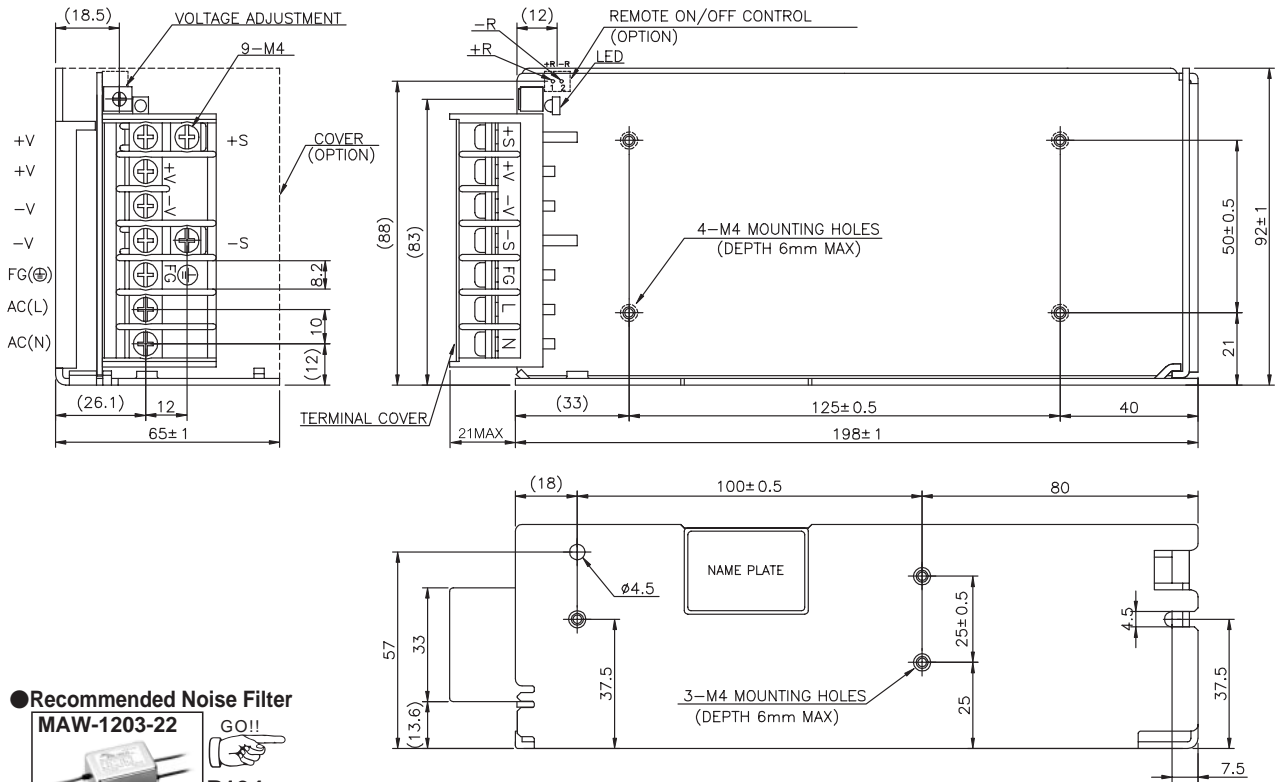

● Recommended Noise Filter
MAW-1203-22
GO!!
P134

● Recommended Power Supply Fixture P198

(Unit: mm)

JWS-SERIES

Unit Type Power Supply

■ JWS300 (300W type)

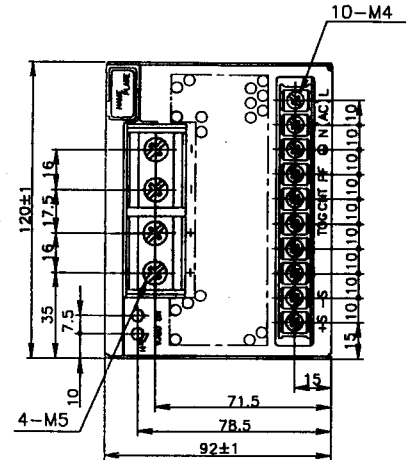
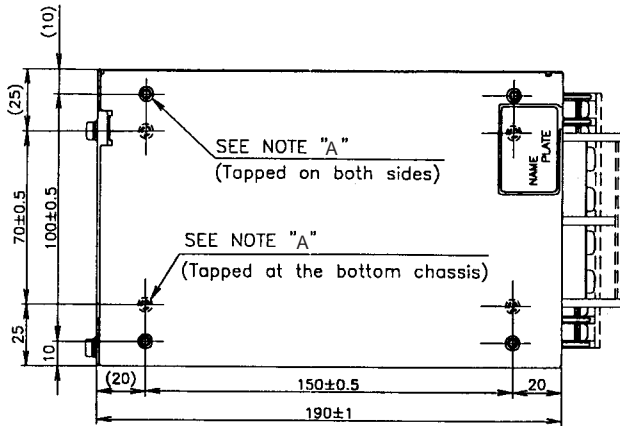

NOTE A: M4 tapped holes (20) for customer chassis mounting.
[Screws must not protrude into power supply by more than 6m/m.]

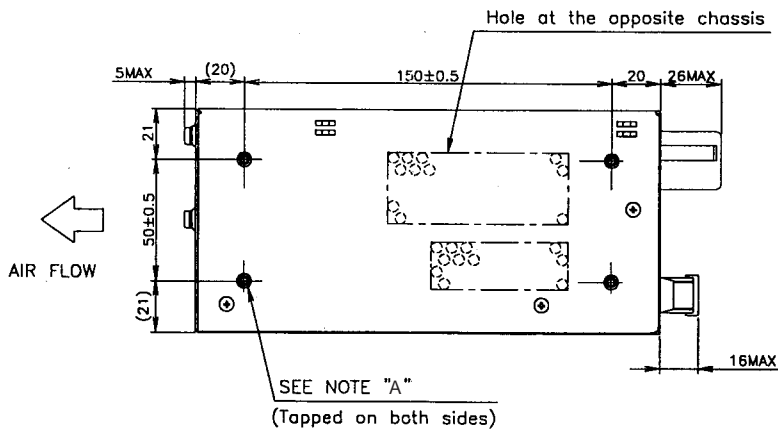

● Recommended Noise Filter



(Unit: mm)

■ JWS600 (600W)

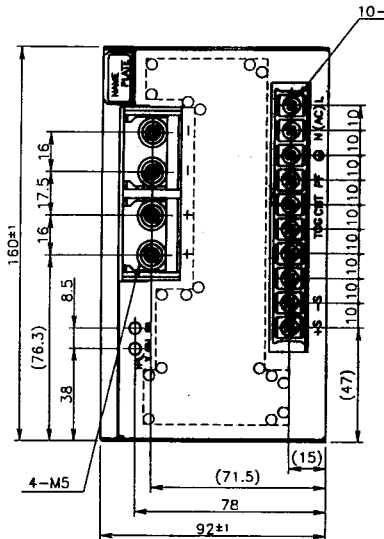
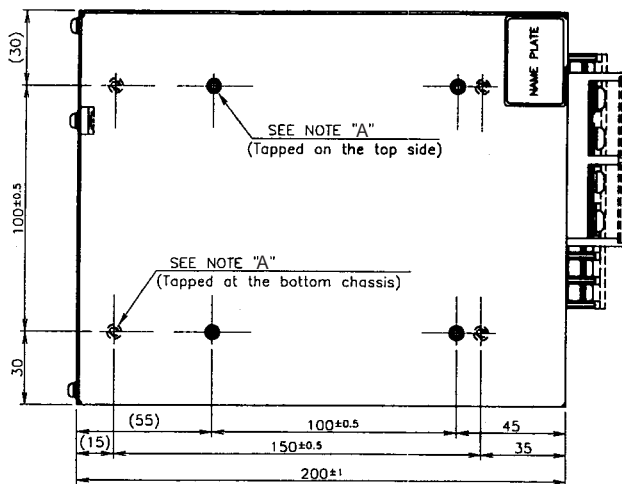

NOTE A: M4 tapped holes (16) for customer chassis mounting.
[Screws must not protrude into power supply by more than 6m/m.]

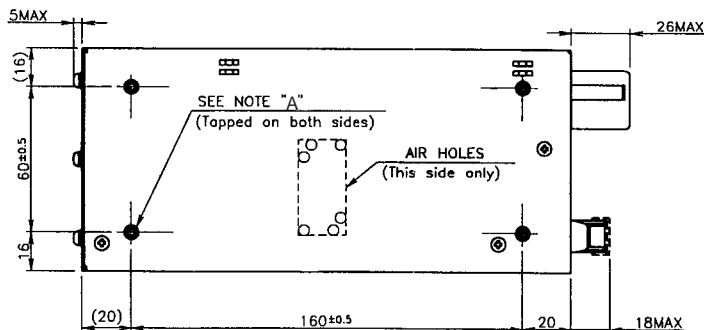

● Recommended Noise Filter



(Unit: mm)