

TA40-11EWA/GWA/YWA/SRWA  
 TC40-11EWA/GWA/YWA/SRWA  
 TBA40-11EGWA  
 TBC40-11EGWA  
 TBA40-12EGWA  
 TBC40-12EGWA

### Features

- 4.0 INCH MATRIX HEIGHT.
- DOT SIZE 10mm.
- LOW CURRENT OPERATION.
- HIGH CONTRAST AND LIGHT OUTPUT.
- COMPATIBLE WITH ASCII AND EBCDIC CODES.
- STACKABLE HORIZONTALLY.
- COLUMN CATHODE AND COLUMN ANODE AVAILABLE.
- EASY MOUNTING ON P.C. BOARDS OR SOCKETS.
- MULTICOLOR AVAILABLE.
- CATEGORIZED FOR LUMINOUS INTENSITY, YELLOW AND GREEN CATEGORIZED FOR COLOR.
- MECHANICALLY RUGGED.
- STANDARD : GRAY FACE, WHITE DOT.

### Description

The High Efficiency Red source color devices are made with Gallium Arsenide Phosphide on Gallium Phosphide Orange Light Emitting Diode.

The Green source color devices are made with Gallium Phosphide Green Light Emitting Diode.

The Yellow source color devices are made with Gallium Arsenide Phosphide on Gallium Phosphide Yellow Light Emitting Diode.

The Super Bright Red source color devices are made with Gallium Aluminum Arsenide Red Light Emitting Diode.

### Package Dimensions & Internal Circuit Diagram

TA/TC40-11

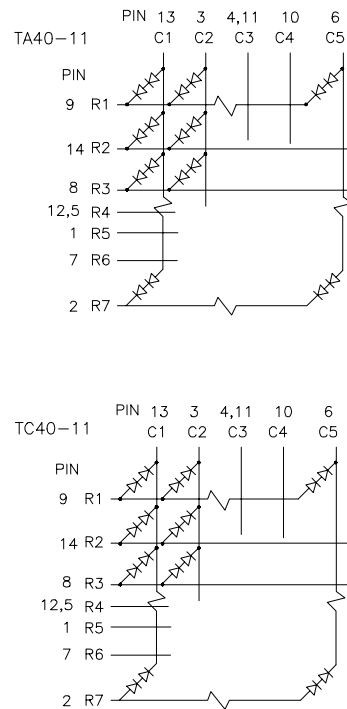
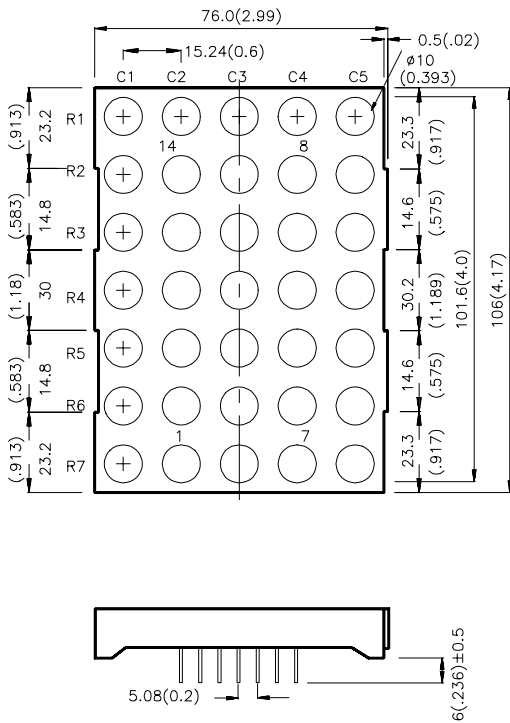

#### Notes:

1. All dimensions are in millimeters (inches), Tolerance is  $\pm 0.25(0.01)$  unless otherwise noted.
2. Specifications are subject to change without notice.

## Package Dimensions & Internal Circuit Diagram

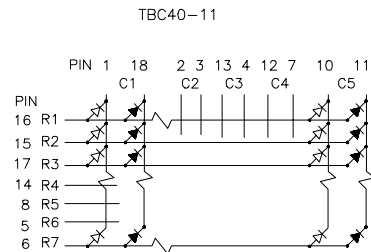
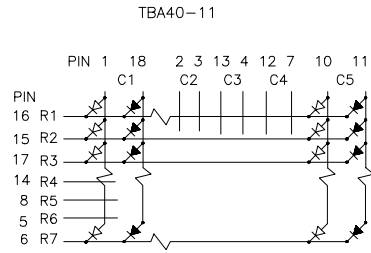
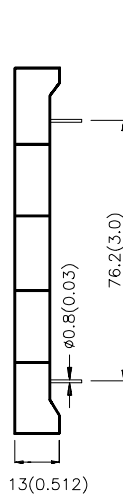
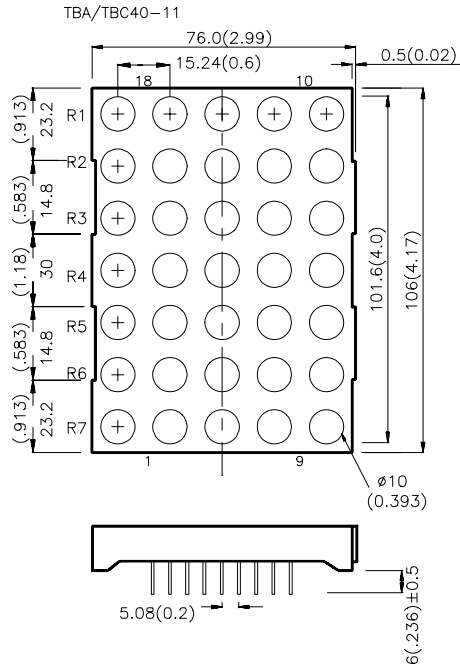

✕ FOR 2 RED CHIPS  
✕ FOR 2 GREEN CHIPS

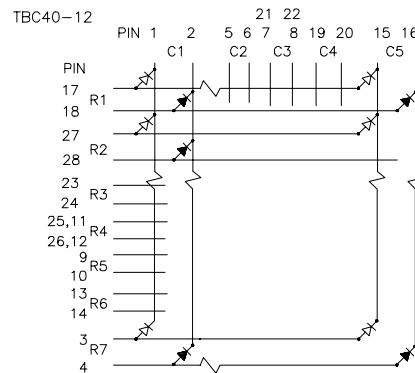
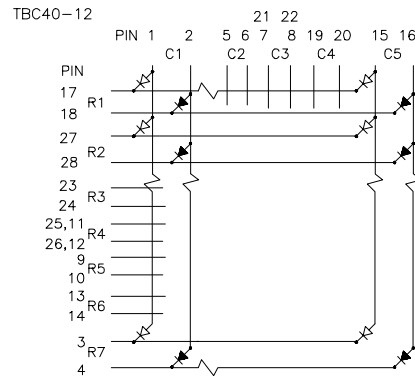
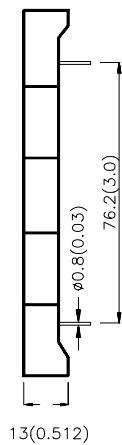
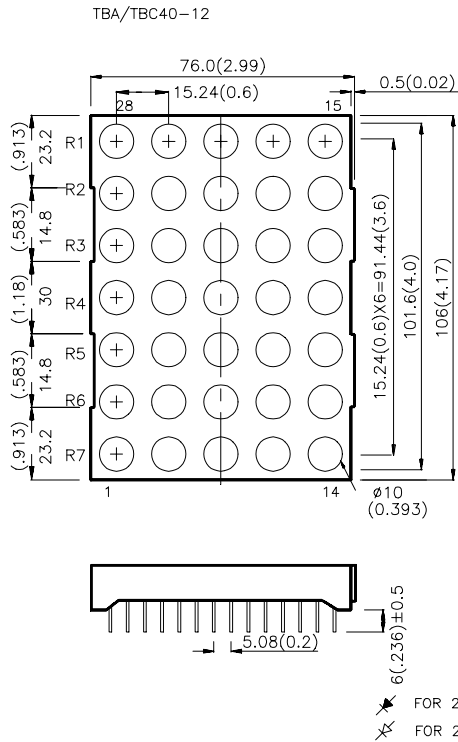

✕ FOR 2 RED CHIPS  
✕ FOR 2 GREEN CHIPS

Notes:

1. All dimensions are in millimeters (inches), Tolerance is  $\pm 0.25$ (0.01") unless otherwise noted.
2. Specifications are subject to change without notice.

## Selection Guide

Part No.	Dice	Iv (ucd) @ 10 mA		Description
		Min.	Typ.	
TA40-11EWA	HIGH EFFICIENCY RED (GaAsP/GaP)	4700	16000	Column Anode
TC40-11EWA				Column Cathode
TA40-11GWA	GREEN (GaP)	8000	24000	Column Anode
TC40-11GWA				Column Cathode
TA40-11YWA	YELLOW (GaAsP/GaP)	3000	8000	Column Anode
TC40-11YWA				Column Cathode
TA40-11SRWA	SUPER BRIGHT RED (GaAlAs)	18000	44000	Column Anode
TC40-11SRWA				Column Cathode
TBA40-11EGWA	HIGH EFFICIENCY RED (GaAsP/GaP) GREEN (GaP)	4700	16000	Column Anode
TBC40-11EGWA		8000	24000	Column Cathode
TBA40-12EGWA	HIGH EFFICIENCY RED (GaAsP/GaP) GREEN (GaP)	4700	16000	Column Anode
TBC40-12EGWA		8000	24000	Column Cathode

## Electrical / Optical Characteristics at T<sub>A</sub>=25°C

Symbol	Parameter	Device	Typ.	Max.	Units	Test Conditions
$\lambda_{peak}$	Peak Wavelength	High Efficiency Red Green Yellow Super Bright Red	627 565 590 660		nm	IF=20mA
$\lambda_D$	Dominate Wavelength	High Efficiency Red Green Yellow Super Bright Red	625 568 588 640		nm	IF=20mA
$\Delta\lambda_{1/2}$	Spectral Line Halfwidth	High Efficiency Red Green Yellow Super Bright Red	45 30 35 20		nm	IF=20mA
C	Capacitance	High Efficiency Red Green Yellow Super Bright Red	15 15 20 45		pF	VF=0V;f=1MHz
V <sub>F</sub>	Forward Voltage	High Efficiency Red Green Yellow Super Bright Red	2.0 2.2 2.1 1.85	2.5 2.5 2.5 2.5	V	IF=20mA
I <sub>R</sub>	Reverse Current	All		10	uA	VR = 5V

## Absolute Maximum Ratings at $T_A=25^\circ\text{C}$

Parameter	High Efficiency Red	Green	Yellow	Super Bright Red	Units
Power dissipation	105	105	105	100	mW
DC Forward Current	30	25	30	30	mA
Peak Forward Current [1]	160	140	140	155	mA
Reverse Voltage	5	5	5	5	V
Operating/Storage Temperature	-40°C To +85°C				
Lead Solder Temperature [2]	260°C For 5 Seconds				

### Notes:

- 1/10 Duty Cycle, 0.1ms Pulse Width.
- 4mm below package base.

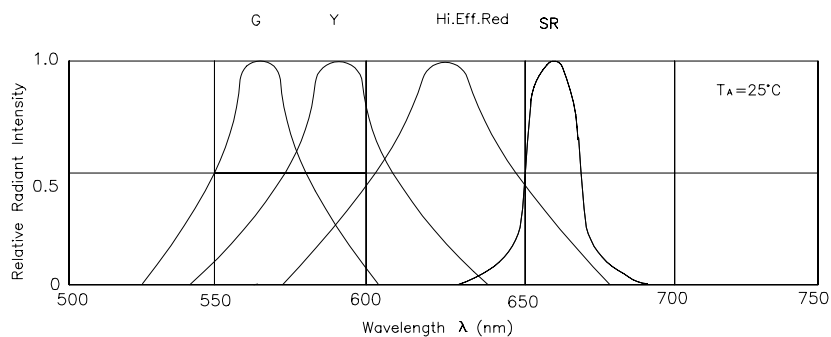

RELATIVE INTENSITY Vs. WAVELENGTH

## High Efficiency Red

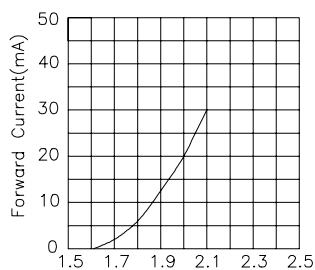

FORWARD CURRENT Vs. FORWARD VOLTAGE

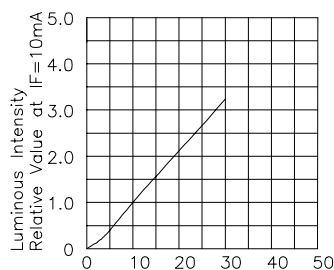

$I_F$ —Forward Current (mA)  
LUMINOUS INTENSITY Vs. FORWARD CURRENT

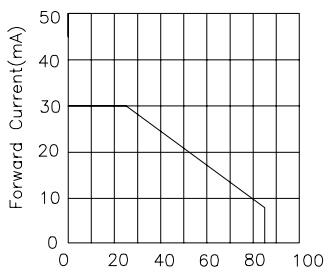

FORWARD CURRENT DERATING CURVE

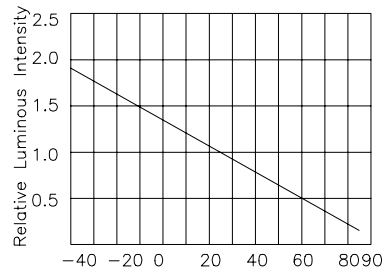

LUMINOUS INTENSITY Vs. AMBIENT TEMPERATURE

## Green

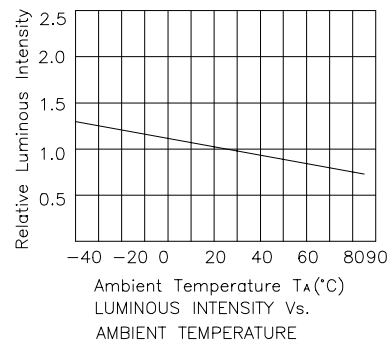
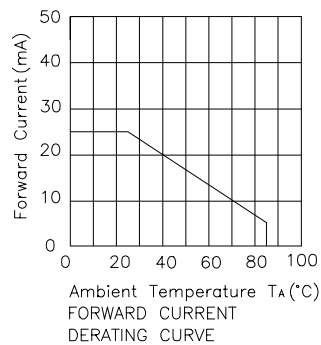
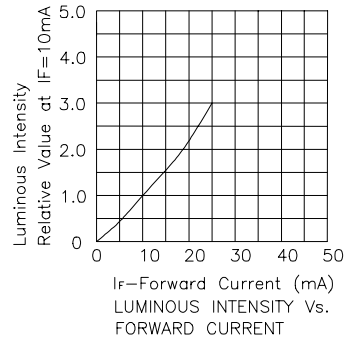
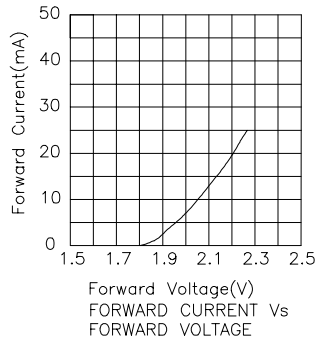

## Yellow

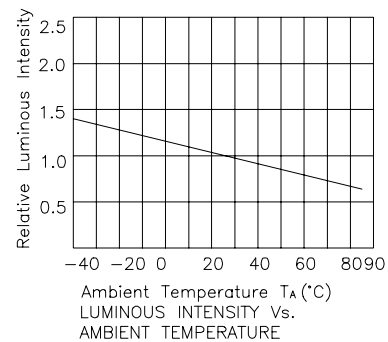
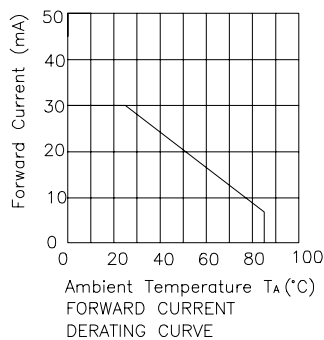
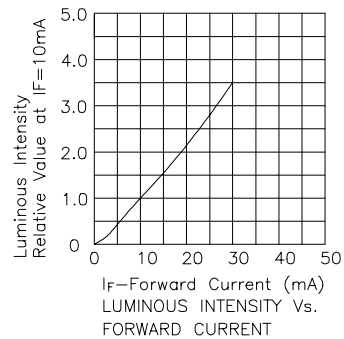
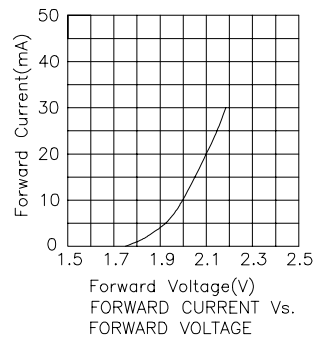

## Super Bright Red

