



WBFBP-06C Plastic-Encapsulate Diodes

FBAT54TW

SURFACE MOUNT SCHOTTKY BARRIER DIODE ARRAYS

DESCRIPTION

Silicon epitaxial planar
PN Junction Guard Ring for Schottky Diode

FEATURES

- Low Forward Voltage Drop
- Fast Switching

APPLICATION

Ultra high speed switching, rectifiers
For portable equipment:(i.e. Mobile phone,MP3, MD,CD-ROM,
DVD-ROM, Note book PC, etc.)

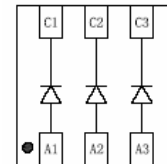
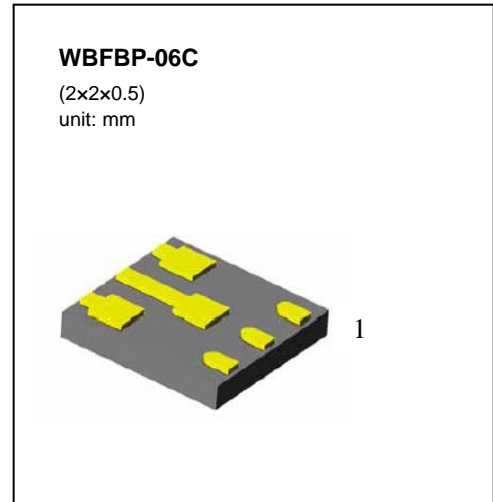

F BAT54TW
Marking:KLA

Maximum Ratings @T_A=25°C

Parameter	Symbol	Limits	Unit
Peak Repetitive reverse voltage DC Blocking Voltage	V _{RM} V _R	30	V
Average Rectified Output Current	I _O	100	mA
Power Dissipation	P _D	150	mW
Junction temperature	T _J	125	°C
Storage temperature range	T _{STG}	-65-125	°C

ELECTRICAL CHARACTERISTICS (T_{amb}=25°C unless otherwise specified)

Parameter	Symbol	Test conditions	MIN	MAX	UNIT
Reverse breakdown voltage	V _(BR)	I _R = 100 μ A	30		V
Reverse voltage leakage current	I _R	V _R =25V		2	uA
Forward voltage	V _F	I _F =0.1mA I _F =1mA I _F =10mA I _F =30mA I _F =100mA		240 320 400 500 1000	mV
Total capacitance	C _T	V _R =1V,f=1MHz		10	pF
Reverse recovery time	t _{rr}	I _F =10mA, I _R =10mA~1mA R _L =100 Ω		5	nS

Typical Characteristics

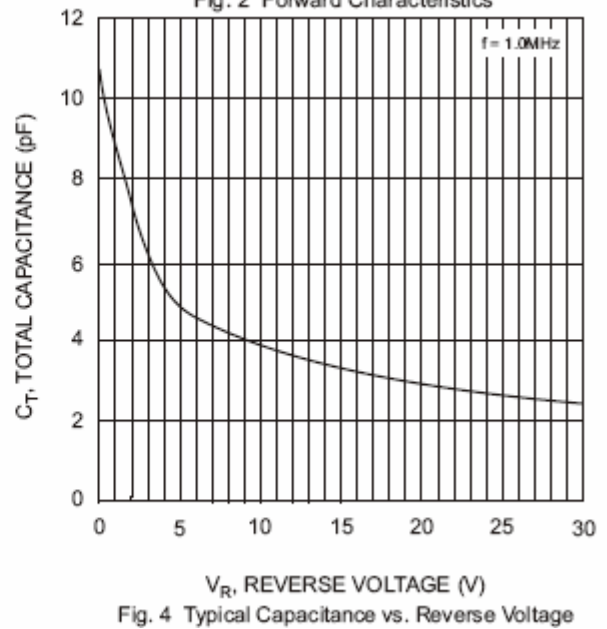
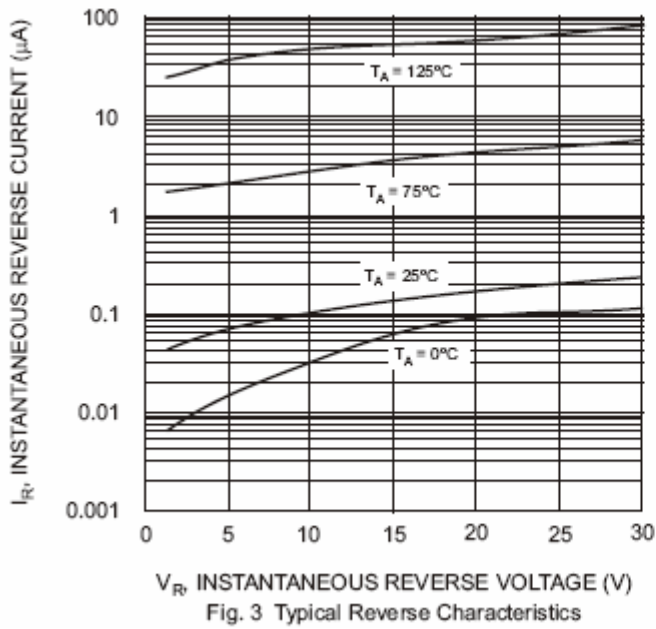
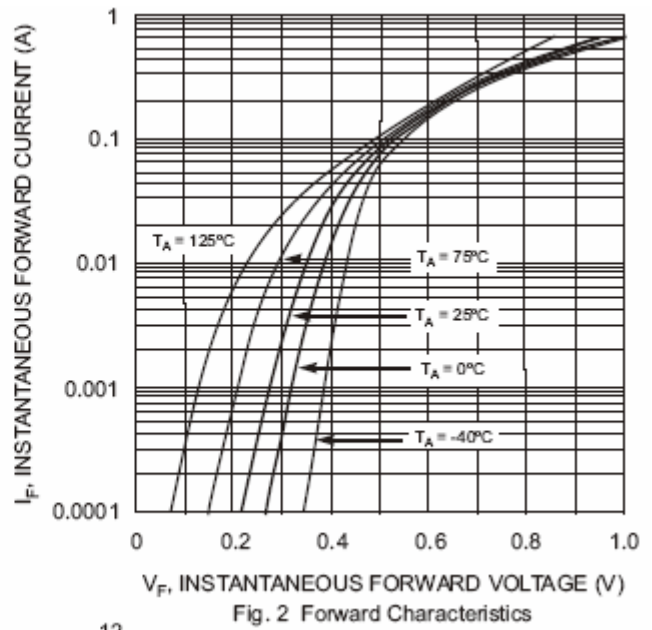
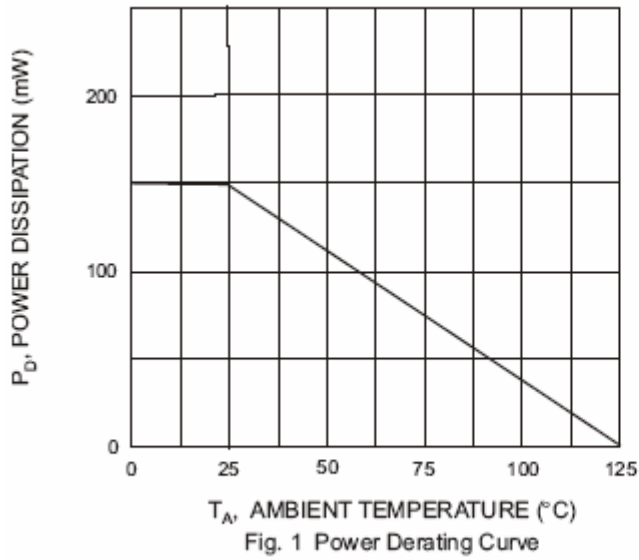



WBFBP-06C(2×2×0.5) PACKAGE OUTLINE DIMENSIONS

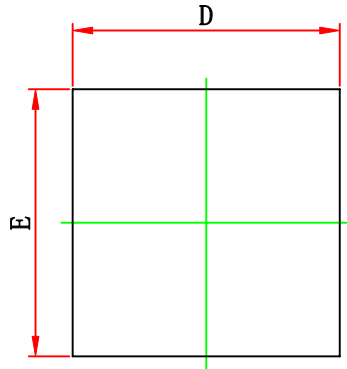

TOP VIEW

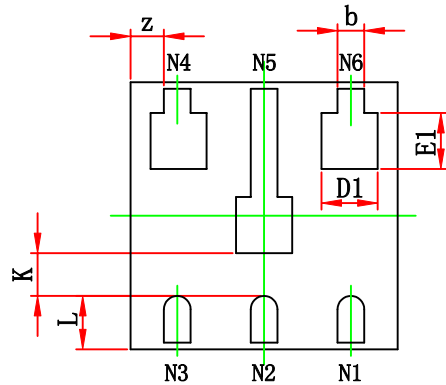

BOTTOM VIEW

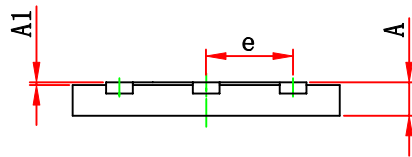

SIDE VIEW

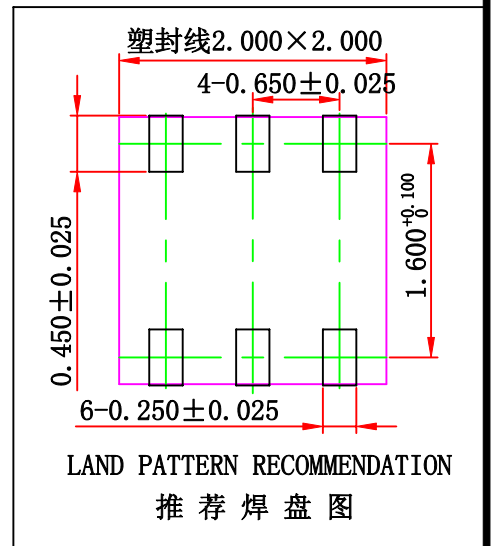

Symbol	Dimensions In Millimeters		Dimensions In Inches	
	Min.	Max.	Min.	Max.
A	0.450	0.550	0.018	0.022
A1	0.000	0.100	0.000	0.004
b	0.150	0.250	0.006	0.010
D	1.900	2.100	0.075	0.083
E	1.900	2.100	0.075	0.083
D1	0.420 REF.		0.017 REF.	
E1	0.420 REF.		0.017 REF.	
e	0.650 TYP.		0.026 TYP.	
L	0.400 REF.		0.016 REF.	
k	0.300 REF.		0.012 REF.	
z	0.500 REF.		0.020 REF.	

APPLICATION CIRCUITS

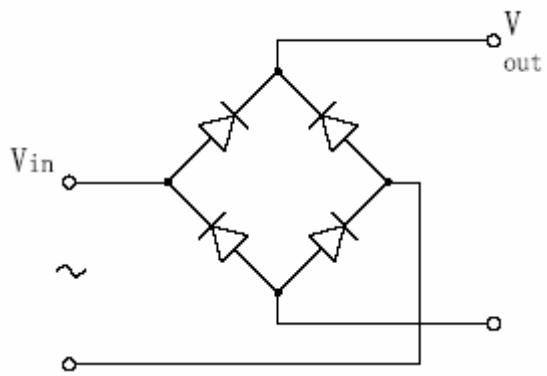

Bridge rectifiers