



IT8208M

Extended PCI Arbiter

Preliminary Specification V0.3



Copyright © 2002 ITE, Inc.

This is Preliminary document release. All specifications are subject to change without notice. The material contained in this document supersedes all previous documentation issued for the related products included herein. Please contact ITE, Inc. for the latest document(s). All sales are subject to ITE's Standard Terms and Conditions, a copy of which is included in the back of this document.

ITE, IT8208M is a trademark of ITE, Inc.
All other trademarks are claimed by their respective owners.
All specifications are subject to change without notice.

Additional copies of this manual or other ITE literature may be obtained from:

ITE, Inc. Marketing Department 8F, No. 233-1, Bao Chiao Rd., Hsin Tien, Taipei County 231, Taiwan, R.O.C.	Phone: (02) 2912-6889 Fax: (02) 2910-2551, 2910-2552
--	---

ITE (USA) Inc. Marketing Department 1235 Midas Way Sunnyvale, CA 94086 U.S.A.	Phone: (408) 530-8860 Fax: (408) 530-8861
---	--

ITE (USA) Inc. Eastern U.S.A. Sales Office 896 Summit St., #105 Round Rock, TX 78664 U.S.A.	Phone: (512) 388-7880 Fax: (512) 388-3108
---	--

If you have any marketing or sales questions, please contact:

Lawrence Liu, at ITE Taiwan: E-mail: lawrence.liu@ite.com.tw, Tel: 886-2-2912-6889 X6071,
Fax: 886-2-26578561

David Lin, at ITE U.S.A: E-mail: david.lin@iteusa.com, Tel: (408) 530-8860 X238,
Fax: (408) 530-8861

Don Gardenhire, at ITE Eastern USA Office: E-mail: don.gardenhire@iteusa.com
Tel: (512) 388-7880, Fax: (512) 388-3108

To find out more about ITE, visit our World Wide Web at:

<http://www.ite.com.tw>
<http://www.iteusa.com>

Or e-mail itesupport@ite.com.tw for more product information/services.



Revision History

Section	Revision	Page No.
6	<ul style="list-style-type: none">• The MAX. value of V_{IL} in section 6 DC Characteristics was revised to "VCC x 0.3".• The MAX. value of V_{IH} has been removed.	11

Contents

1. Features.....	1
2. General Description	3
3. Block Diagram	5
4. Pin Configuration.....	7
5. IT8208M Pin Descriptions	9
6. DC Characteristics (VCC = 3.3V±0.3V. Ta=0°C to 70°C).....	11
7. AC Characteristics	13
8. Package Information.....	15
9. Ordering Information.....	17

Figures

Figure 2-1. Arbitration Scheme of IT8208M.....	3
Figure 3-1. Extended PCI Arbiter Scheme.....	5
Figure 7-1. PCI Request Delay Timing	13
Figure 7-2. PCI Grant Delay Timing	13
Figure 7-3. PCI Grant Separation Timing	13

Tables

Table 4-1. Pins Listed in Numeric Order.....	7
Table 5-1. Pin Descriptions of Extended PCI Arbiter	9
Table 5-2. Pin Descriptions of PCI Bus Clock	9
Table 5-3. Pin Descriptions of Power/Ground Signals.....	9
Table 7-1. PCI Request Delay Timing Table	13
Table 7-2. PCI Grant Delay Timing Table.....	13
Table 7-3. PCI Grant Separation Timing Table	13



1. Features

- **Extended PCI Arbiter**
 - Supports 1 PCI arbiter to extend 1 set of SYSGNT# and SYSREQ#, which can be utilized to support 3 PCI Masters
- **Input PCI Clock**
 - Supports input clock frequency from 25MHz to 66MHz
- **16-pin SOP**

2. General Description

The IT8208M incorporates an extended PCI arbiter to support more PCI master bus request.

The extended PCI arbiter utilizes one set of SYSGNT# and SYSREQ# to support 3 PCI Masters, so that two more PCI Masters can be supported for the system. PCISTOP# input signal is useful to facilitate the fairness arbitration. The algorithm of this arbiter uses a rotation arbitration priority that is illustrated in Figure 2-1.

The PCI bus clock can support frequency from 25 MHz to 66 MHz. The IT8208M is available in 16 SOP package.

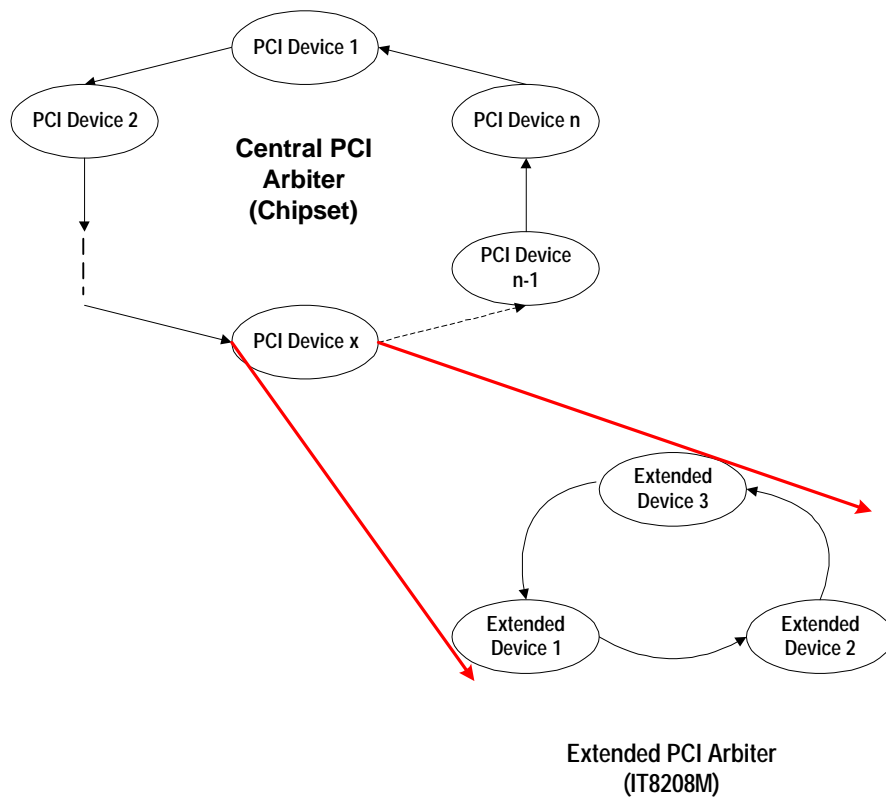

Figure 2-1. Arbitration Scheme of IT8208M

3. Block Diagram

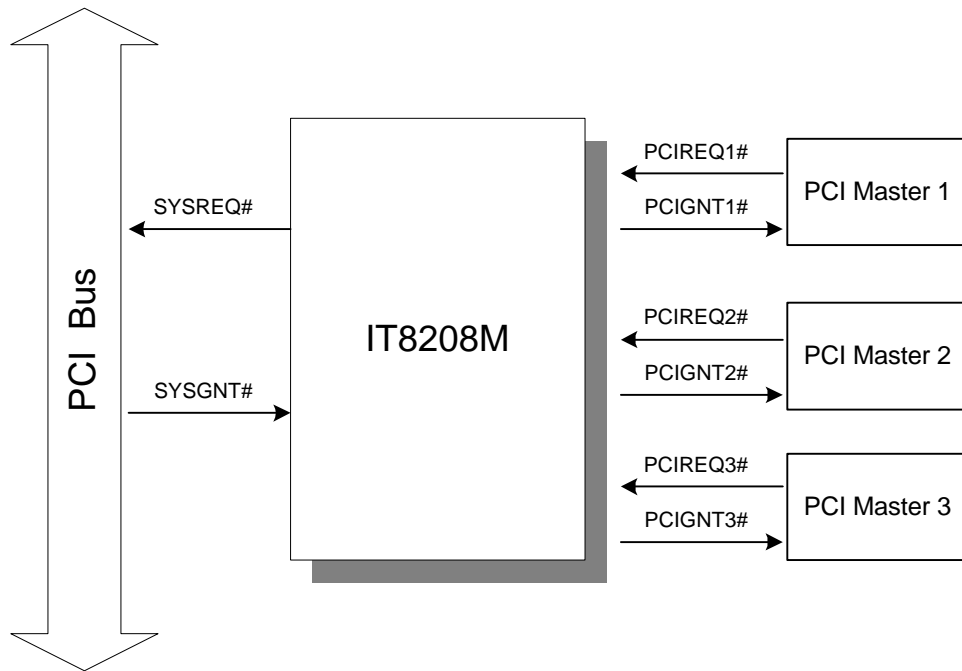
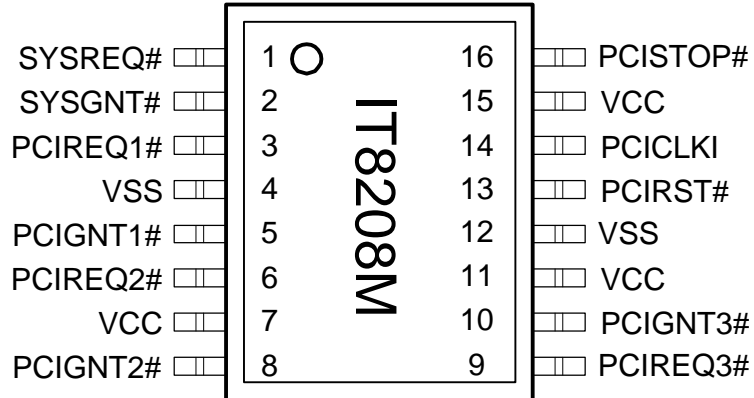

Figure 3-1. Extended PCI Arbitrator Scheme

4. Pin Configuration



Pin	Signal	Pin	Signal
1	SYSREQ#	9	PCIREQ3#
2	SYSGNT#	10	PCIGNT3#
3	PCIREQ1#	11	VCC
4	VSS	12	VSS
5	PCIGNT1#	13	PCIRST#
6	PCIREQ2#	14	PCICLK
7	VCC	15	VCC
8	PCIGNT2#	16	PCISTOP#

Table 4-1. Pins Listed in Numeric Order



5. IT8208M Pin Descriptions

Table 5-1. Pin Descriptions of Extended PCI Arbiter

Signal	Pin(s) No.	Attribute	Description
Extended PCI Arbiter Signals (3.3V CMOS I/F, 5V tolerant)			
PCISTOP#	16	PIU	<i>PCI Bus STOP# Signal</i>
SYSREQ#	1	O12	<i>PCI Bus Request</i>
SYSGNT#	2	PIU	<i>PCI Bus Grant</i>
PCIREQ1#	3	PIU	<i>Request Signal from Extended PCI Master 1</i>
PCIGNT1#	5	O12	<i>Grant Signal to Extended PCI Master 1</i>
PCIREQ2#	6	PIU	<i>Request Signal from Extended PCI Master 2</i>
PCIGNT2#	8	O12	<i>Grant Signal to Extended PCI Master 2</i>
PCIREQ3#	9	PIU	<i>Request Signal from Extended PCI Master 3</i>
PCIGNT3#	10	O12	<i>Grant Signal to Extended PCI Master 3</i>
PCIRST#	13	IK	<i>PCI Bus RST# Signal</i>

Table 5-2. Pin Descriptions of PCI Bus Clock

Signal	Pin(s) No.	Attribute	Description
PCI Bus Clock Signals (3.3V CMOS I/F)			
PCICLKI	14	I	<i>PCICLK Input</i>

Table 5-2. Pin Descriptions of Power/Ground Signals

Signal	Pin(s) No.	Attribute	Description
Power Ground Signals			
VSS	4, 12	I	<i>Ground</i>
VCC	11, 15	I	<i>Power Supply of 3.3V</i>

Notes: IO cell types are described as below:

I: Input PAD.

IK: Schmitt Trigger Input PAD.

PIU: PCI Bus Specified Input PAD (integrated a 75K ohms pull-up resistor).

O12: 12mA Output PAD.



6. DC Characteristics (VCC = 3.3V±0.3V. Ta=0°C to 70°C)

Absolute Maximum Ratings*

Applied Voltage of VCC, AVCC -0.3V to +4.6V
 Input Voltage of 3.3V Interface -0.3V to VCC+0.3V
 Input Voltage of 5V tolerant Interface ... -0.3V to 5.25V
 Tcase 0°C to +70°C
 Storage Temperature -40°C to +125°C

***Comments**

Stresses above those listed under "Absolute Maximum Ratings" may cause permanent damage to this device. These are stress ratings only. Functional operation of this device at these or any other conditions above those indicated in the operational sections of this specification is not implied, and exposure to absolute maximum rating conditions for extended periods may affect device reliability.

DC Electrical Characteristics (Ta = 0°C to 70°C)

Symbol	Parameter	Min.	Typ.	Max.	Conditions
V _{IL}	Input Low Voltage	- 0.3V		VCC x 0.3	VCC=3.0 ~ 3.6V
V _{IH}	Input High Voltage	VCC x 0.7			VCC=3.0 ~ 3.6V
V _{OL}	Output Low Voltage			0.5	I _{OL} = -12mA
V _{OH}	Output High Voltage	2.4			I _{OH} = 12mA
I _{IL}	Input Low Current	-1μA		1μA	V _{IL} = V _{SS} no pull-up or pull-down
I _{IH}	Input High Current	-1μA		1μA	V _{IH} = VCC no pull-up or pull-down
I _{OZ}	Tri-state Leakage Current	-10μA		10μA	
C _{in}	Input Capacitance		3pF		
C _{out}	Output Capacitance		3pF		
C _{bld}	Bi-directional Buffer		3pF		
R _i	Input Pull-Up Resistance	40KΩ	75KΩ	170KΩ	V _{IL} =0V

7. AC Characteristics

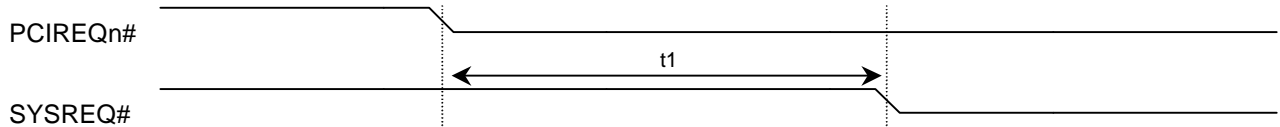

Figure 7-1. PCI Request Delay Timing

Table 7-1. PCI Request Delay Timing Table

Symbol	Parameter	Min.	Typ.	Max.	Unit
t_1	PCIREQn# (n=1, 2, 3) to SYSREQ# asserted	0	-	7	ns

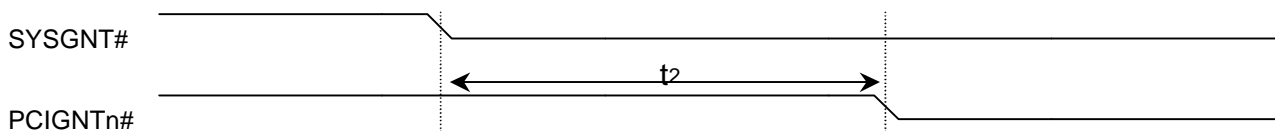

Figure 7-2. PCI Grant Delay Timing

Table 7-2. PCI Grant Delay Timing Table

Symbol	Parameter	Min.	Typ.	Max.	Unit
t_2	SYSGNT# to PCIGNTn# (n=1, 2, 3) asserted	0	-	8.5	ns

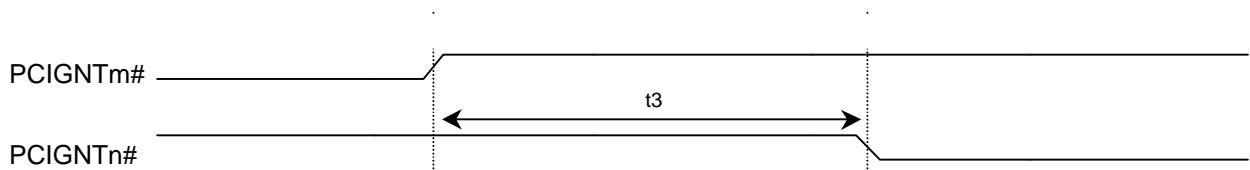

Figure 7-3. PCI Grant Separation Timing

Table 7-3. PCI Grant Separation Timing Table

Symbol	Parameter	Min.	Typ.	Max.	Unit
t_3	PCIGNTm# (m=1, 2, 3) deasserted to PCIGNTn# (n=1, 2, 3) asserted (n ≠ m)	1	-	-	Clock Period

8. Package Information

SOP16L Outline Dimensions

unit: inches/mm

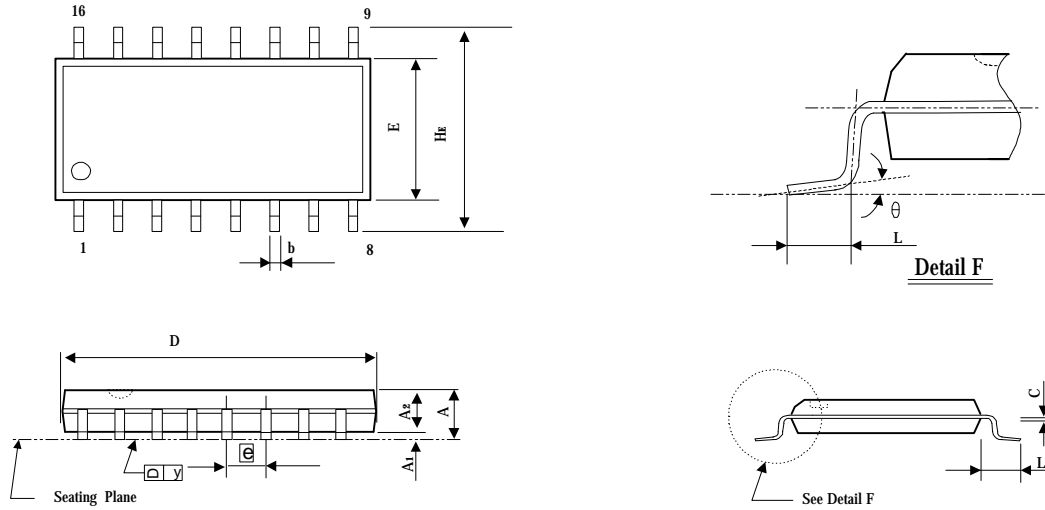

Symbol	Dimension in inches			Dimension in mm		
	Min	Nom	Max	Min	Nom	Max
A	0.053	0.064	0.069	1.35	1.63	1.75
A ₁	0.004	0.006	0.010	0.10	0.15	0.25
A ₂	0.051	0.055	0.059	1.30	1.40	1.50
b	0.013	0.016	0.020	0.33	0.41	0.51
C	0.007	-	0.010	0.19	-	0.25
D	0.386	0.390	0.394	9.80	9.91	10.01
E	0.150	0.154	0.157	3.80	3.90	4.00
e	0.050BSC			1.27BSC		
H _E	0.228	0.236	0.244	5.80	6.00	6.20
L	0.016	0.025	0.050	0.40	0.64	1.27
L ₁	0.042REF.			1.07REF.		
y	-	-	0.004	-	-	0.10
θ	0°	-	8°	0°	-	8°



9. Ordering Information

Part No.	Package
IT8208M	16 SOP