

International
IR Rectifier

8TQ...
 8TQ...S

SCHOTTKY RECTIFIER

8 Amp

$$I_{F(AV)} = 8 \text{ Amp}$$

$$V_R = 80 - 100V$$

Major Ratings and Characteristics



Characteristics	8TQ	Units
$I_{F(AV)}$ Rectangular waveform	8	A
V_{RRM} range	80 - 100	V
I_{FSM} @tp = 5 μ s sine	850	A
V_F @8 Apk, $T_J = 125^\circ\text{C}$	0.58	V
T_J range	-55 to 175	$^\circ\text{C}$

Description/ Features

The 8TQ Schottky rectifier series has been optimized for low reverse leakage at high temperature. The proprietary barrier technology allows for reliable operation up to 175 $^\circ\text{C}$ junction temperature. Typical applications are in switching power supplies, converters, free-wheeling diodes, and reverse battery protection.

- 175 $^\circ\text{C}$ T_J operation
- High purity, high temperature epoxy encapsulation for enhanced mechanical strength and moisture resistance
- Low forward voltage drop
- High frequency operation
- Guard ring for enhanced ruggedness and long term reliability

Case Styles

8TQ...	8TQ... S
 <p>TO-220</p>	 <p>D²PAK</p>

Voltage Ratings

Part number	8TQ080	8TQ100
V_R Max. DC Reverse Voltage (V)	80	100
V_{RWM} Max. Working Peak Reverse Voltage (V)		

Absolute Maximum Ratings

Parameters	8TQ	Units	Conditions
$I_{F(AV)}$ Max. Average Forward Current * See Fig. 5	8	A	50% duty cycle @ $T_C = 157^\circ\text{C}$, rectangular wave form
I_{FSM} Max. Peak One Cycle Non-Repetitive Surge Current * See Fig. 7	850	A	5 μs Sine or 3 μs Rect. pulse
	230		10ms Sine or 6ms Rect. pulse
E_{AS} Non-Repetitive Avalanche Energy	7.50	mJ	$T_J = 25^\circ\text{C}$, $I_{AS} = 0.50$ Amps, $L = 60$ mH
I_{AR} Repetitive Avalanche Current	0.50	A	Current decaying linearly to zero in 1 μsec Frequency limited by T_J max. $V_A = 1.5 \times V_R$ typical

Electrical Specifications

Parameters	8TQ	Units	Conditions
V_{FM} Max. Forward Voltage Drop (1) * See Fig. 1	0.72	V	@ 8A
	0.88	V	@ 16A
	0.58	V	@ 8A
	0.69	V	@ 16A
I_{RM} Max. Reverse Leakage Current (1) * See Fig. 2	0.55	mA	$T_J = 25^\circ\text{C}$
	7	mA	$T_J = 125^\circ\text{C}$
C_T Max. Junction Capacitance	500	pF	$V_R = 5V_{DC}$ (test signal range 100Khz to 1Mhz) 25°C
L_S Typical Series Inductance	8	nH	Measured lead to lead 5mm from package body
dv/dt Max. Voltage Rate of Change (Rated V_R)	10000	V/ μs	

(1) Pulse Width < 300 μs , Duty Cycle < 2%

Thermal-Mechanical Specifications

Parameters	8TQ	Units	Conditions
T_J Max. Junction Temperature Range	-55 to 175	$^\circ\text{C}$	
T_{stg} Max. Storage Temperature Range	-55 to 175	$^\circ\text{C}$	
R_{thJC} Max. Thermal Resistance Junction to Case	2.0	$^\circ\text{C}/\text{W}$	DC operation * See Fig. 4
R_{thCS} Typical Thermal Resistance, Case to Heatsink	0.50	$^\circ\text{C}/\text{W}$	Mounting surface, smooth and greased
wt Approximate Weight	2 (0.07)	g (oz.)	
T Mounting Torque	Min.	6 (5)	Kg-cm (lbf-in)
	Max.	12 (10)	

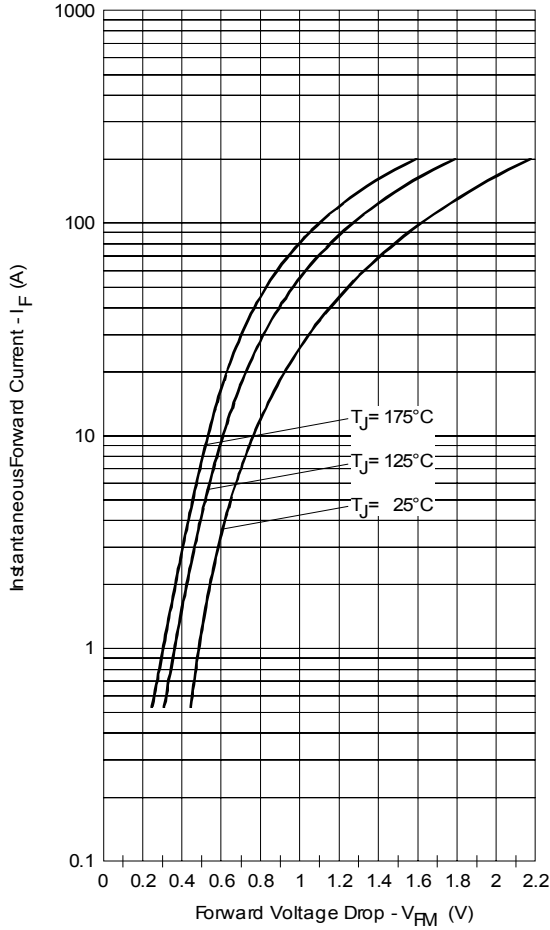

Fig. 1 - Maximum Forward Voltage Drop Characteristics

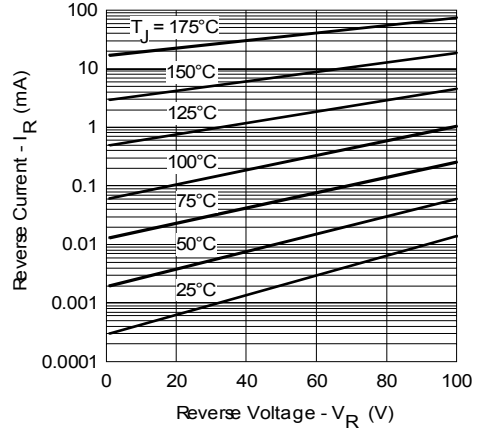

Fig. 2 - Typical Values of Reverse Current Vs. Reverse Voltage

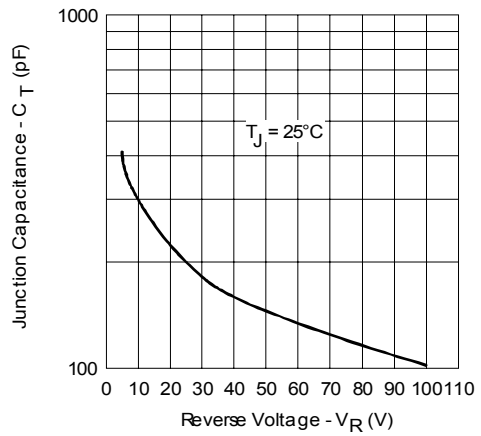

Fig. 3 - Typical Junction Capacitance Vs. Reverse Voltage

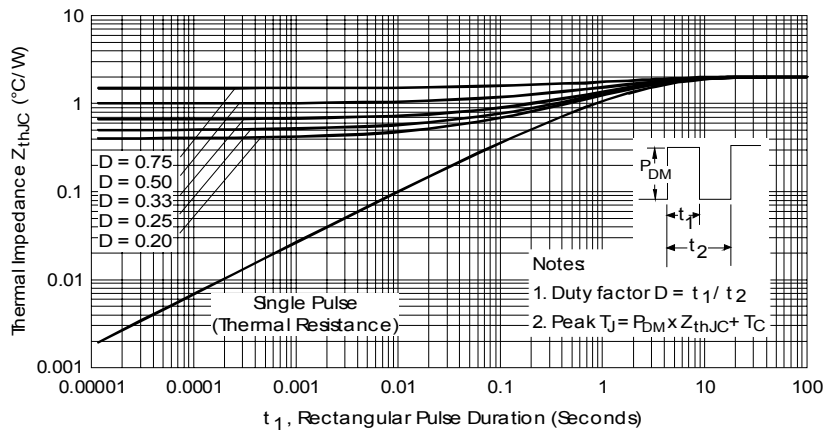

Fig. 4 - Maximum Thermal Impedance Z_{thJC} Characteristics

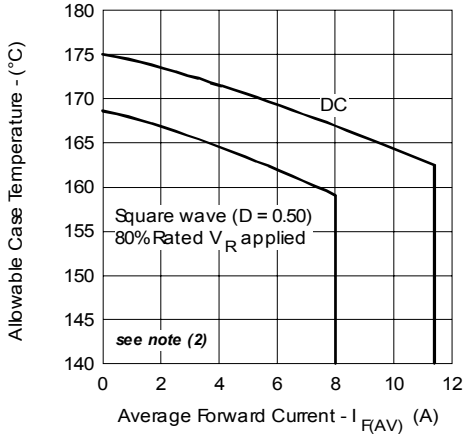

Fig. 5 - Maximum Allowable Case Temperature Vs. Average Forward Current

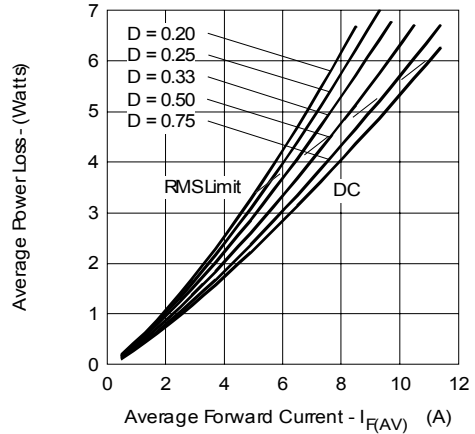

Fig. 6 - Forward Power Loss Characteristics

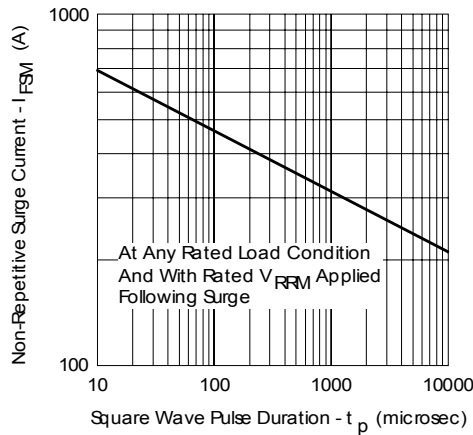

Fig. 7 - Maximum Non-Repetitive Surge Current

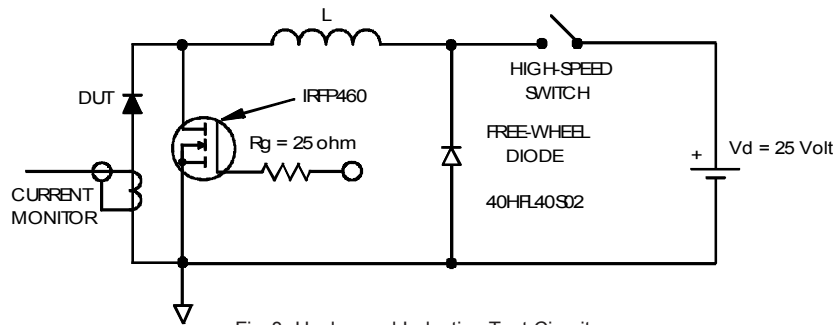

Fig. 8 - Unclamped Inductive Test Circuit

(2) Formula used: $T_c = T_j - (Pd + Pd_{REV}) \times R_{thJC}$;

Pd = Forward Power Loss = $I_{F(AV)} \times V_{FM} @ (I_{F(AV)} / D)$ (see Fig. 6);

Pd_{REV} = Inverse Power Loss = $V_{R1} \times I_{R1} (1 - D)$; $I_{R1} @ V_{R1} = 80\%$ rated V_R

Outline Table

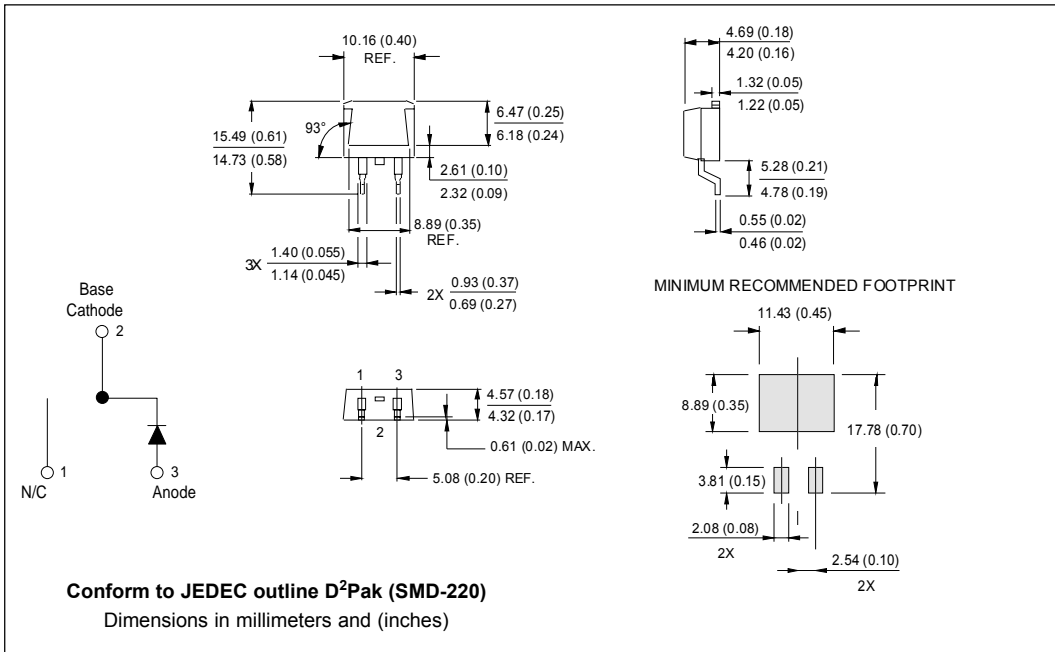
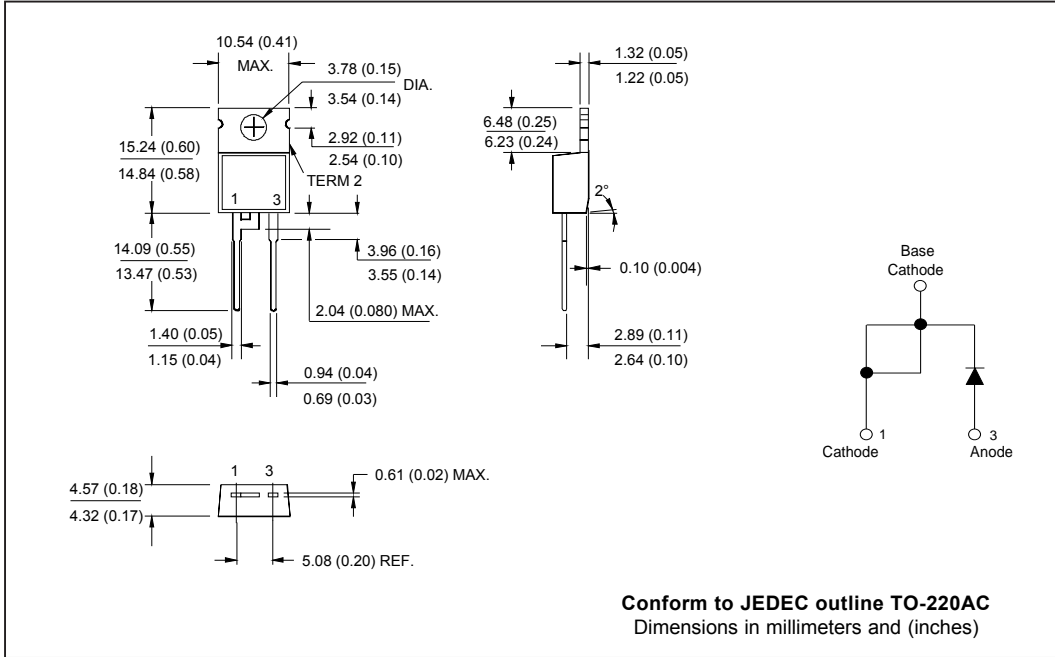

Ordering Information Table

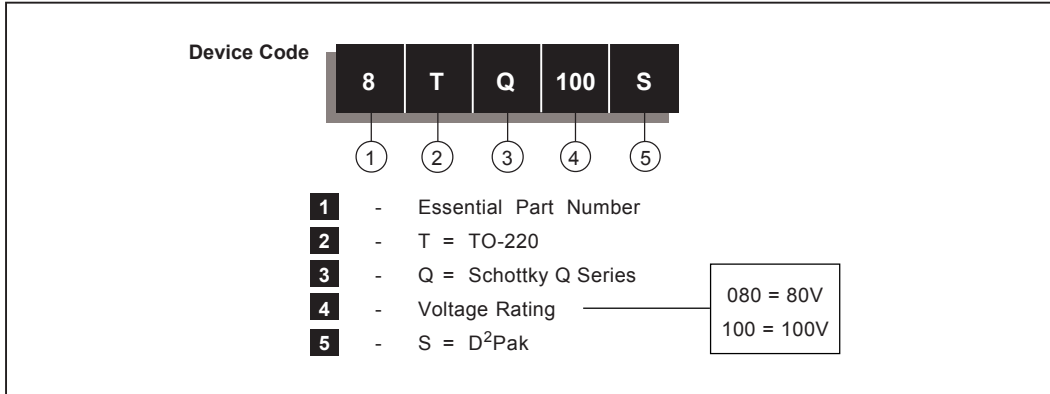

```

8TQ100
*****
*   This model has been developed by   *
*   Wizard SPICE MODEL GENERATOR (1999) *
*   (International Rectifier Corporation) *
*   Contain Proprietary Information    *
*****
*   SPICE Model Diode is composed by a  *
*   simple diode plus paralled VCG2T    *
*****
.SUBCKT 8TQ100 ANO CAT
D1 ANO 1 DMOD (0.07089)
*Define diode model
.MODEL DMOD D(IS=1.15938021883115E-03A,N=1.95244918720315,BV=120V,
+ IBV=5.37891460505463A,RS= 0.00127602,CJO=9.9895753025115E-09,
+ VJ=2.30070034831946,XTI=2, EG=0.758916909331649)
*****
*Implementation of VCG2T
VX 1 2 DC 0V
R1 2 CAT TRES 1E-6
.MODEL TRES RES(R=1,TC1=-90.2420977904848)
GP1 ANO CAT VALUE={-ABS(I(VX))*(EXP(((1.635248E-02/-90.2421)*(V(2,CAT)*1E6)/(I(VX)+1E-6)-
1))+1)*4.011038E-03*ABS(V(ANO,CAT)))-1}
*****
.ENDS 8TQ100

Thermal Model Subcircuit
.SUBCKT 8TQ100 5 1

CTHERM1 5 4 1.45E+00
CTHERM2 4 3 4.54E+00
CTHERM3 3 2 1.09E+01
CTHERM4 2 1 1.01E+02

R THERM1 5 4 2.49E+00
R THERM2 4 3 5.20E-04
R THERM1 3 2 5.43E-01
R THERM1 2 1 3.05E-02

.ENDS 8TQ100
    
```

Data and specifications subject to change without notice.
This product has been designed and qualified for Industrial Level.
Qualification Standards can be found on IR's Web site.

International
IOR Rectifier

IR WORLD HEADQUARTERS: 233 Kansas St., El Segundo, California 90245, USA Tel: (310) 252-7105
TAC Fax: (310) 252-7309
Visit us at www.irf.com for sales contact information. 07/03