

**INPUT RECTIFIER DIODE**

**Description/Features**

The 20ETS.. rectifier **SAFEIR** series has been optimized for very low forward voltage drop, with moderate leakage. The glass passivation technology used has reliable operation up to 150°C junction temperature.

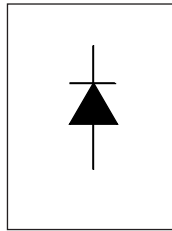

$V_F$	< 1V @ 10A
$I_{FSM}$	= 300A
$V_{RRM}$	800 to 1600V

Typical applications are in input rectification and these products are designed to be used with International Rectifier Switches and Output Rectifiers which are available in identical package outlines.

**Output Current in Typical Applications**

	Single-phase Bridge	Three-phase Bridge	Units
Capacitive input filter $T_A = 55^\circ\text{C}$ , $T_J = 125^\circ\text{C}$ , common heatsink of $1^\circ\text{C/W}$	16.3	21	A

**Major Ratings and Characteristics**

Characteristics	20ETS..	Units
$I_{F(AV)}$ Sinusoidal waveform	20	A
$V_{RRM}$	800 to 1600	V
$I_{FSM}$	300	A
$V_F$ @ 10 A, $T_J = 25^\circ\text{C}$	1.0	V
$T_J$	-40 to 150	$^\circ\text{C}$

**Package Outline**

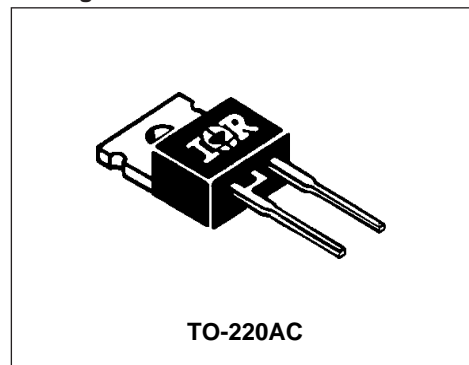

Also available in SMD-220 package (series 20ETS..S)

## Voltage Ratings

Part Number	$V_{RRM}$ , maximum peak reverse voltage V	$V_{RSM}$ , maximum non repetitive peak reverse voltage V	$I_{RRM}$ 150°C mA
20ETS08	800	900	1
20ETS12	1200	1300	
20ETS16	1600	1700	

Provide terminal coating for voltages above 1200V

## Absolute Maximum Ratings

Parameters	20ETS..	Units	Conditions
$I_{F(AV)}$ Max. Average Forward Current	20	A	@ $T_C = 105^\circ\text{C}$ , 180° conduction half sine wave
$I_{FSM}$ Max. Peak One Cycle Non-Repetitive Surge Current	250	A	10ms Sine pulse, rated $V_{RRM}$ applied
	300		10ms Sine pulse, no voltage reapplied
$I^2t$ Max. $I^2t$ for fusing	316	$A^2s$	10ms Sine pulse, rated $V_{RRM}$ applied
	442		10ms Sine pulse, no voltage reapplied
$I^2\sqrt{t}$ Max. $I^2\sqrt{t}$ for fusing	4420	$A^2\sqrt{s}$	$t = 0.1$ to 10ms, no voltage reapplied

## Electrical Specifications

Parameters	20ETS..	Units	Conditions
$V_{FM}$ Max. Forward Voltage Drop	1.1	V	@ 20A, $T_J = 25^\circ\text{C}$
$r_t$ Forward slope resistance	10.4	mΩ	$T_J = 150^\circ\text{C}$
$V_{F(TO)}$ Threshold voltage	0.85	V	
$I_{RM}$ Max. Reverse Leakage Current	0.1	mA	$T_J = 25^\circ\text{C}$
	1.0		$T_J = 150^\circ\text{C}$

$V_R = \text{rated } V_{RRM}$

## Thermal-Mechanical Specifications

Parameters	20ETS..	Units	Conditions
$T_J$ Max. Junction Temperature Range	-40 to 150	$^\circ\text{C}$	
$T_{stg}$ Max. Storage Temperature Range	-40 to 150	$^\circ\text{C}$	
$R_{thJC}$ Max. Thermal Resistance Junction to Case	1.3	$^\circ\text{C/W}$	DC operation
$R_{thJA}$ Max. Thermal Resistance Junction to Ambient	62	$^\circ\text{C/W}$	
$R_{thCS}$ Typ. Thermal Resistance Case to Heatsink	0.5	$^\circ\text{C/W}$	Mounting surface, smooth and greased
wt Approximate Weight	2 (0.07)	g (oz.)	
T Mounting Torque	Min. 6 (5)	Kg-cm (lbf-in)	
	Max. 12 (10)		
Case Style	TO-220AC		

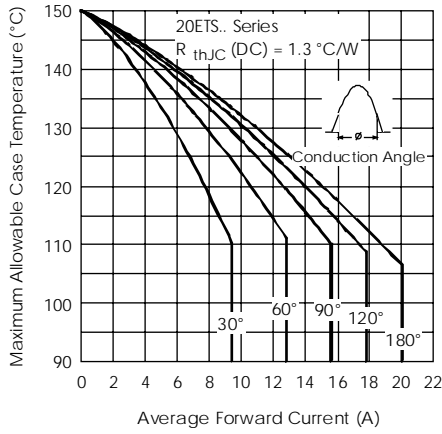

Fig. 1 - Current Rating Characteristics

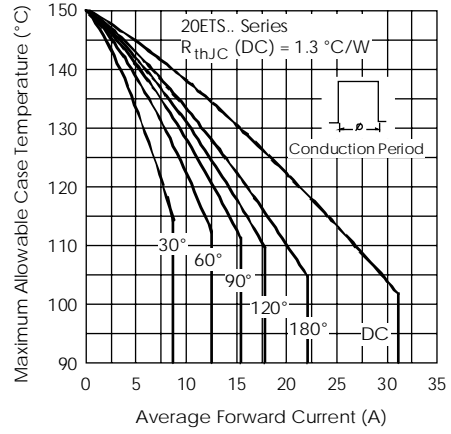

Fig. 2 - Current Rating Characteristics

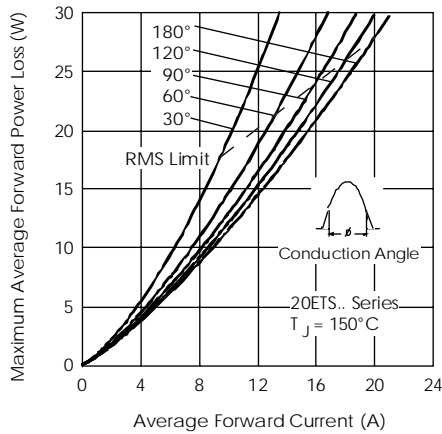

Fig. 3 - Forward Power Loss Characteristics

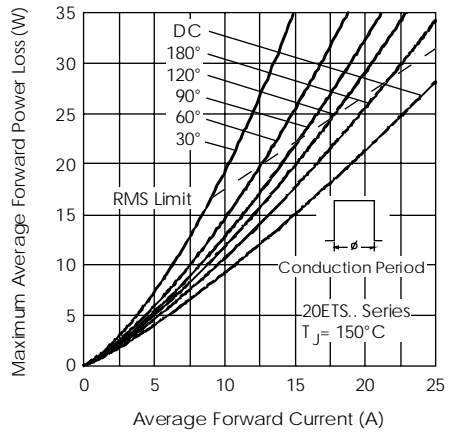

Fig. 4 - Forward Power Loss Characteristics

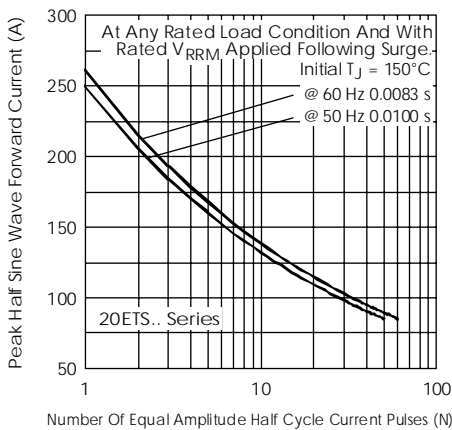

Fig. 5 - Maximum Non-Repetitive Surge Current

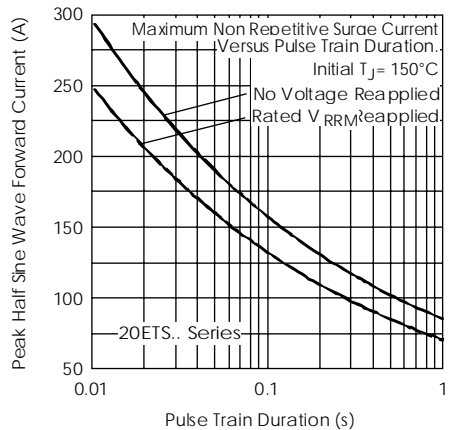

Fig. 6 - Maximum Non-Repetitive Surge Current

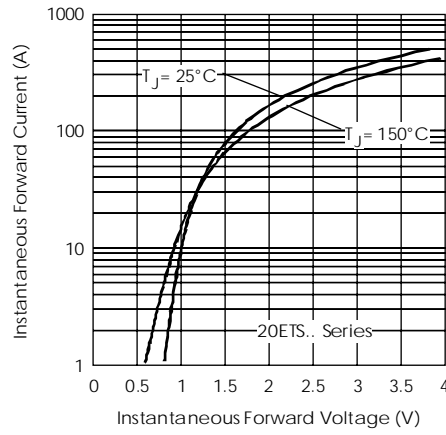

Fig. 7 - Forward Voltage Drop Characteristics

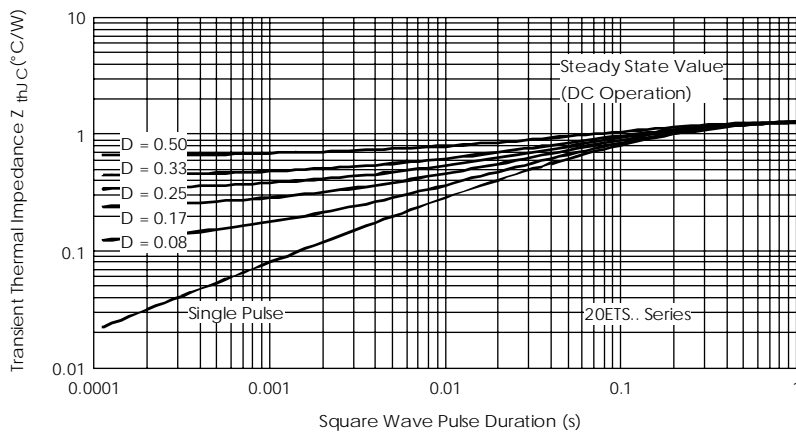
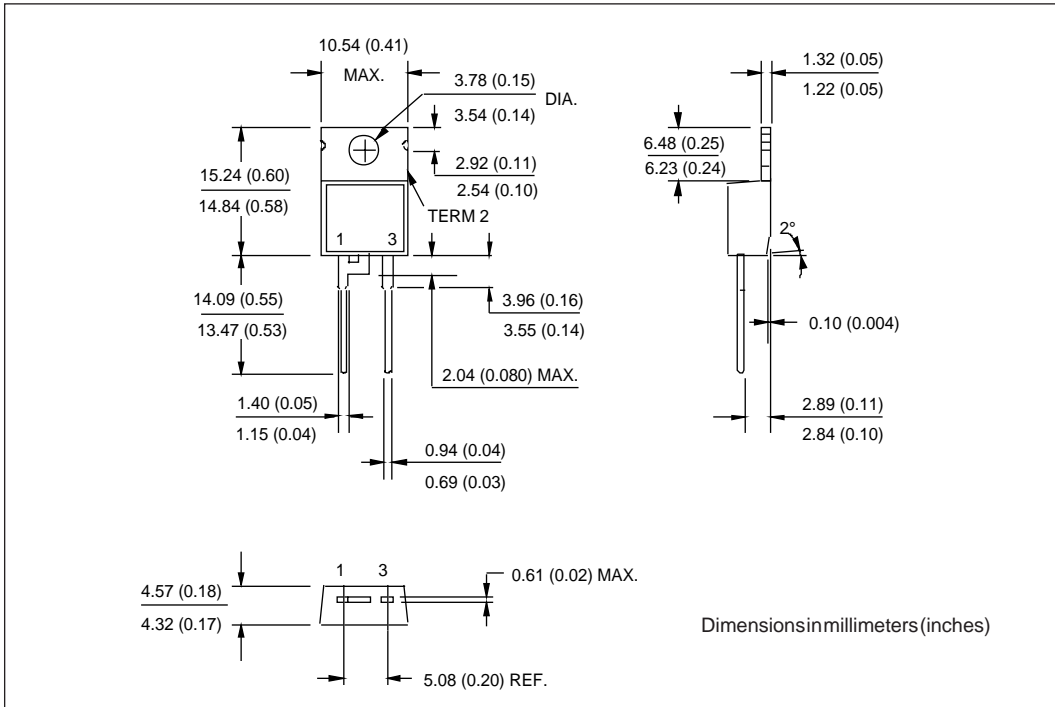

Fig.8- Thermal Impedance  $Z_{thjC}$  Characteristics

Outline Table



Ordering Information Table

