

International IOR Rectifier

115CNQ015A

SCHOTTKY RECTIFIER
New GenIII D-61 Package

110 Amp

Major Ratings and Characteristics



Characteristics	115CNQ015A	Units
$I_{F(AV)}$ Rectangular waveform	110	A
V_{RRM}	15	V
I_{FSM} @tp=5 μ s sine	5050	A
V_F @55Apk, $T_J=75^\circ\text{C}$ (per leg)	0.33	V
T_J range	-55 to 125	$^\circ\text{C}$

Description/Features

The 115CNQ015A center tap Schottky rectifier module has been optimized for ultra low forward voltage drop specifically for the OR-ing of parallel power supplies. The proprietary barrier technology allows for reliable operation up to 125 $^\circ\text{C}$ junction temperature. Typical applications are in parallel switching power supplies, converters, reverse battery protection, and redundant power subsystems.

- 125 $^\circ\text{C}$ T_J operation ($V_R < 5\text{V}$)
- Center tap module
- Optimized for OR-ing applications
- Ultra low forward voltage drop
- High frequency operation
- Guard ring for enhanced ruggedness and long term reliability
- High purity, high temperature epoxy encapsulation for enhanced mechanical strength and moisture resistance
- *New fully transfer-mold low profile, small footprint, high current package*

Case Styles

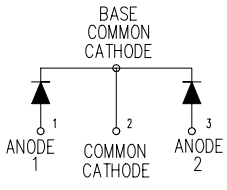
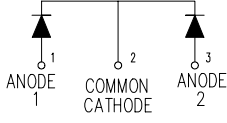
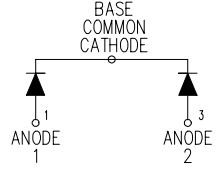
115CNQ015A	115CNQ015ASM	115CNQ015ASL
		
 <p>BASE COMMON CATHODE</p> <p>ANODE 1 COMMON CATHODE 2 ANODE 3</p> <p>D61-8</p>	 <p>BASE COMMON CATHODE</p> <p>ANODE 1 COMMON CATHODE 2 ANODE 3</p> <p>D61-8-SM</p>	 <p>BASE COMMON CATHODE</p> <p>ANODE 1 ANODE 3 2</p> <p>D61-8-SL</p>

Voltage Ratings

Part number	115CNQ015A	
V_R Max. DC Reverse Voltage (V) @ $T_J = 100^\circ\text{C}$		15
V_{RWM} Max. DC Reverse Voltage (V) @ $T_J = 125^\circ\text{C}$		5

Absolute Maximum Ratings

Parameters	115CNQ	Units	Conditions
$I_{F(AV)}$ Max. Average Forward Current * See Fig. 5 Per Leg Per Device	55	A	50% duty cycle @ $T_C = 112^\circ\text{C}$, rectangular wave form
	110		
I_{FSM} Max. Peak One Cycle Non-Repetitive Surge Current (Per Leg) * See Fig. 7	5050	A	5 μs Sine or 3 μs Rect. pulse
	830		10ms Sine or 6ms Rect. pulse
E_{AS} Non-Repetitive Avalanche Energy (Per Leg)	54	mJ	$T_J = 25^\circ\text{C}$, $I_{AS} = 2$ Amps, $L = 4.5$ mH
I_{AR} Repetitive Avalanche Current (Per Leg)	2	A	Current decaying linearly to zero in 1 μsec Frequency limited by T_J , max. $V_A = 3 \times V_R$ typical

Electrical Specifications

Parameters	115CNQ	Units	Conditions
V_{FM} Max. Forward Voltage Drop (Per Leg) * See Fig. 1 (1)	0.37	V	@ 55A $T_J = 25^\circ\text{C}$
	0.46	V	@ 110A
	0.33	V	@ 55A $T_J = 75^\circ\text{C}$
	0.43	V	@ 110A
I_{RM} Max. Reverse Leakage Current (Per Leg) * See Fig. 2 (1)	20	mA	$T_J = 25^\circ\text{C}$ $V_R = \text{rated } V_R$
	1200	mA	$T_J = 100^\circ\text{C}$
	900	mA	$T_J = 100^\circ\text{C}$ $V_R = 12\text{V}$
	540	mA	$T_J = 100^\circ\text{C}$ $V_R = 5\text{V}$
C_T Max. Junction Capacitance (Per Leg)	5500	pF	$V_R = 5V_{DC}$ (test signal range 100Khz to 1Mhz) 25°C
L_S Typical Series Inductance (Per Leg)	5.5	nH	Measured lead to lead 5mm from package body
dv/dt Max. Voltage Rate of Change (Rated V_R)	10000	V/ μs	

(1) Pulse Width < 300 μs , Duty Cycle <2%

Thermal-Mechanical Specifications

Parameters	115CNQ	Units	Conditions
T_J Max. Junction Temperature Range	-55 to 125	$^\circ\text{C}$	
T_{stg} Max. Storage Temperature Range	-55 to 150	$^\circ\text{C}$	
R_{thJC} Max. Thermal Resistance Junction to Case (Per Leg)	0.5	$^\circ\text{C}/\text{W}$	DC operation * See Fig. 4
R_{thJC} Max. Thermal Resistance Junction to Case (Per Package)	0.25	$^\circ\text{C}/\text{W}$	DC operation
R_{thCS} Typical Thermal Resistance, Case to Heatsink (D61-8 Only)	0.30	$^\circ\text{C}/\text{W}$	Mounting surface, smooth and greased Device flatness < 5 mils
wt Approximate Weight	7.8(0.28)	g(oz.)	
T Mounting Torque (D61-8 Only)	Min.	40(35)	Kg-cm (lbf-in)
	Max.	58(50)	

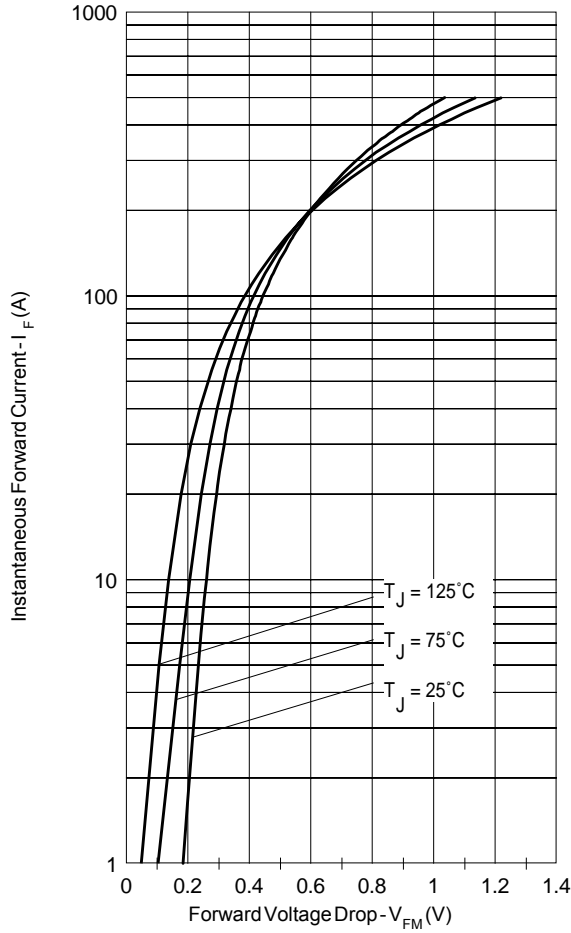

Fig. 1 - Max. Forward Voltage Drop Characteristics (Per Leg)

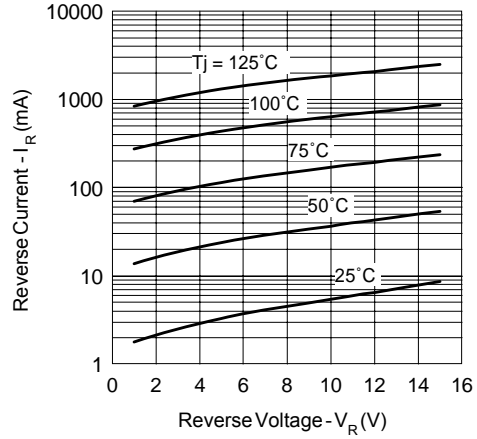

Fig. 2 - Typical Values Of Reverse Current Vs. Reverse Voltage (Per Leg)

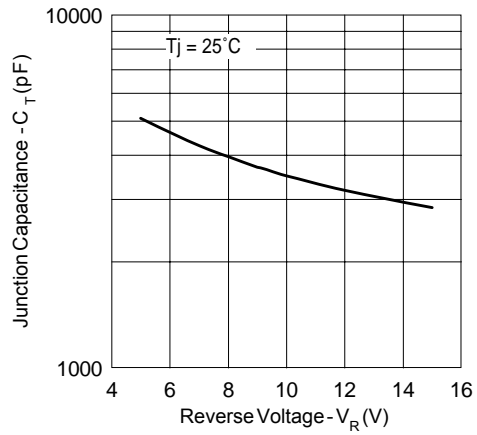

Fig. 3 - Typical Junction Capacitance Vs. Reverse Voltage (Per Leg)

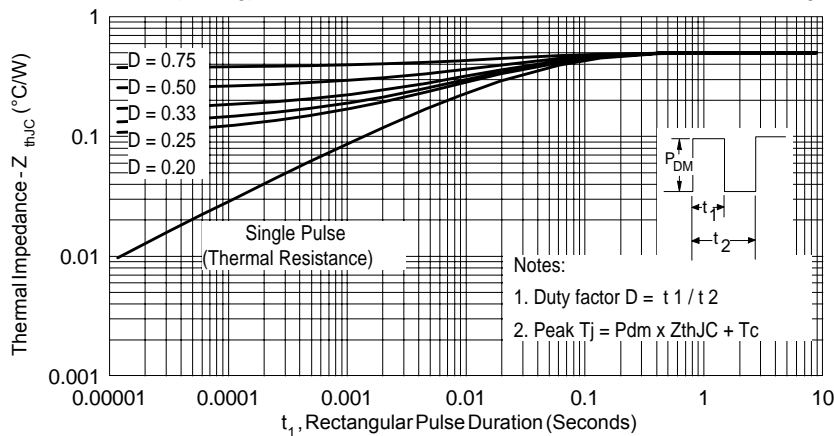

Fig. 4 - Max. Thermal Impedance Z_{thJC} Characteristics (Per Leg)

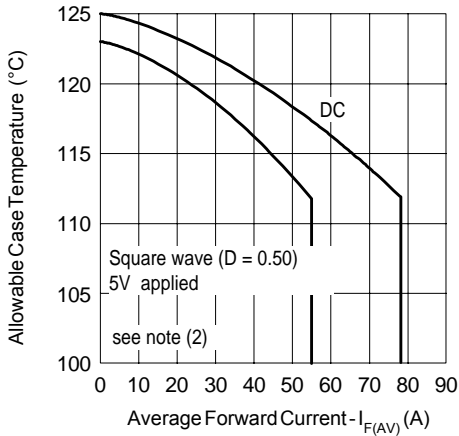

Fig. 5 - Max. Allowable Case Temperature Vs. Average Forward Current (Per Leg)

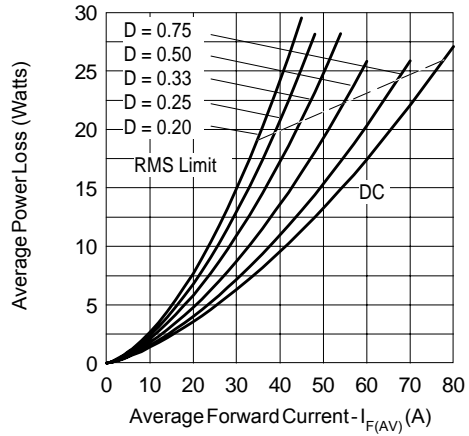

Fig. 6 - Forward Power Loss Characteristics (Per Leg)

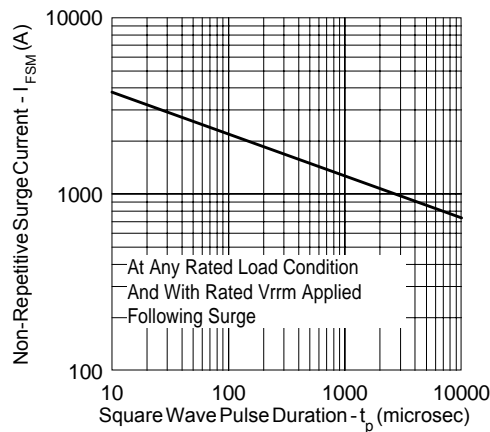

Fig. 7 - Max. Non-Repetitive Surge Current (Per Leg)

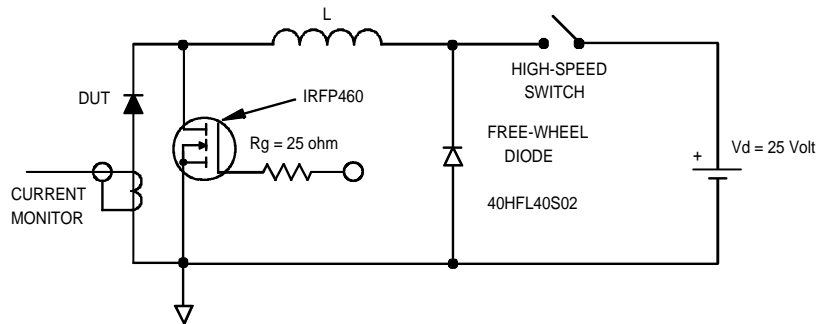

Fig. 8 - Unclamped Inductive Test Circuit

(2) Formula used: $T_c = T_j - (Pd + Pd_{REV}) \times R_{thJC}$

Pd = Forward Power Loss = $I_{F(AV)} \times V_{FM} @ (I_{F(AV)} / D)$ (see Fig. 6);

Pd_{REV} = Inverse Power Loss = $V_{R1} \times I_R (1 - D)$; $I_R @ V_{R1} = 5V$

Outline Table

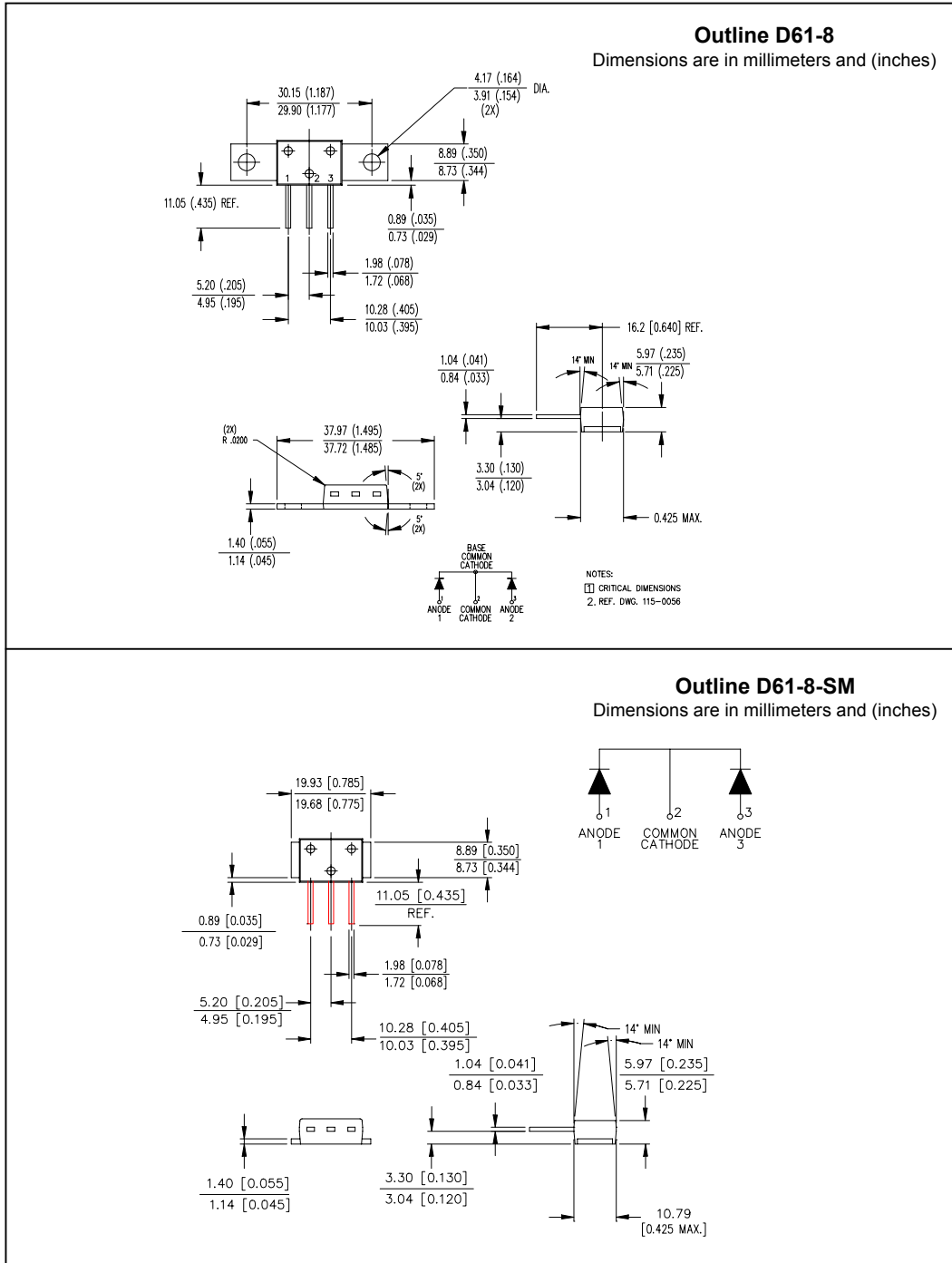

Outline D61-8-SM
 Dimensions are in millimeters and (inches)

Outline Table

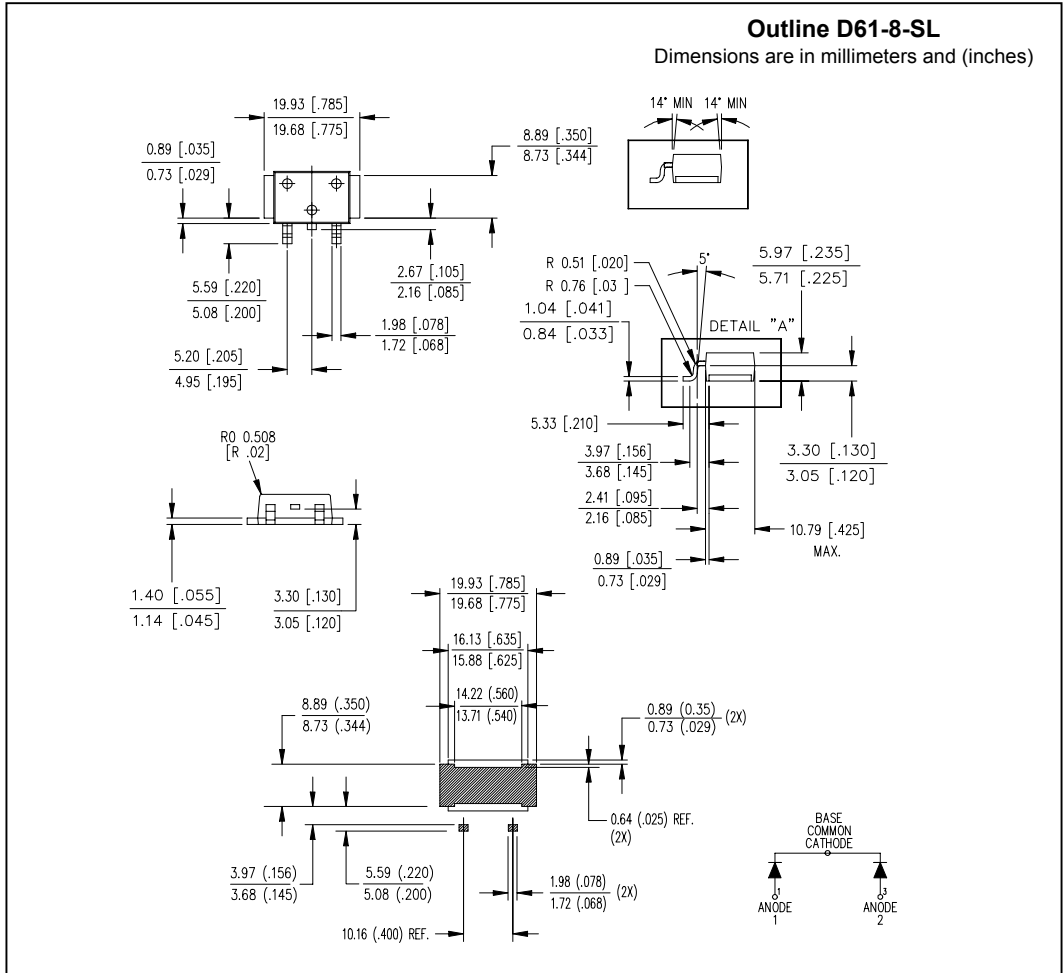

Marking Information

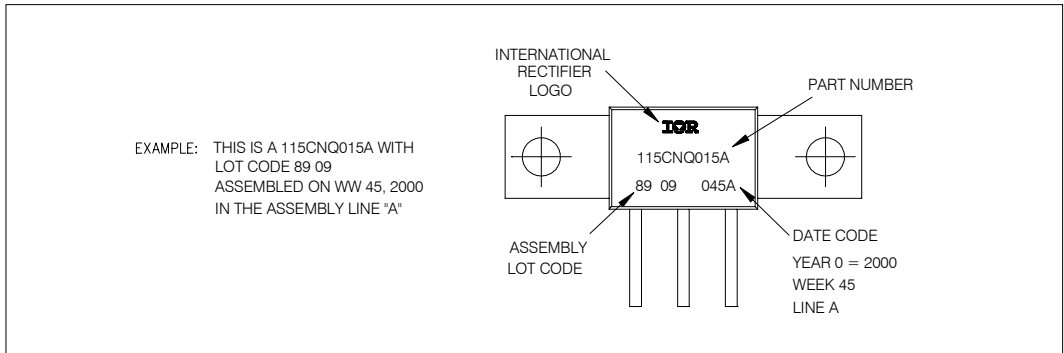

Data and specifications subject to change without notice.
This product has been designed and qualified for Industrial Level.
Qualification Standards can be found on IR's Web site.

International
IOR Rectifier

IR WORLD HEADQUARTERS: 233 Kansas St., El Segundo, California 90245, USA Tel: (310) 252-7105
TAC Fax: (310) 252-7309
Visit us at www.irf.com for sales contact information. 09/01