

FEATURES

- Low offset voltage and offset current
- Low offset voltage and current drift
- Low input bias current
- Low input noise voltage
- Large common mode and differential voltage ranges

ABSOLUTE MAXIMUM RATINGS

Supply Voltage	± 22V
Internal Power Dissipation (Note 1)	
Metal Can	500mW
Differential Input Voltage	± 30V
Input Voltage (Note 2)	± 15V
Storage Temperature Range	- 65°C to + 150°C
Operating Temperature Range (HC)	0°C to 70°C
(HM) ..	- 55°C to + 125°C
Lead Temperature (Soldering, 10s)	300°C
.....	260°C
Output Short Circuit Duration (Note 3)	Indefinite

Note 1: Rating applies to ambient temperatures up to 70°C. Above 70°C ambient derate linearly at 6.3mW/°C for Metal Can, 8.3mW/°C for the DIP, and 5.6mW/°C for the Mini DIP.

Note 2: For supply voltages less than ±15V, the absolute maximum input voltage is equal to the supply voltage.

Note 3: Short Circuit may be to ground or either supply. Rating applies to +125°C case temperature or +75°C ambient temperature for I_{SET} ≤ 30μA.

ORDERING INFORMATION

	Dice	TO-99 Can
μA777C	μA777C/D	μA777HC
μA777M	μA777M/D	μA777MC

GENERAL DESCRIPTION

The μA777 is a monolithic Precision Operational Amplifier. It is an excellent choice when performance versus cost trade-offs are possible between super beta or FET input operational amplifiers and low cost general purpose operational amplifiers. Low offset and bias currents improve system accuracy when used in applications such as long term integrators, sample and hold circuits and high source impedance summing amplifiers. Even though the input bias current is extremely low, the μA777 maintains full ±30V differential voltage range. High common mode input voltage range, latch-up protection, short circuit protection and simple frequency compensation make the device versatile and easily used.

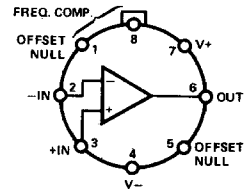
PIN CONFIGURATION
**8-LEAD METAL CAN
(TOP VIEW)**

(outline dwg TY)

ELECTRICAL CHARACTERISTICS FOR μA777 ($V_s = \pm 15V$, $T_A = 25^\circ C$, $C_C = 30pF$ unless otherwise specified)

PARAMETERS		CONDITIONS	MIN	TYP	MAX	UNITS
Input Offset Voltage		$R_S \leq 50k\Omega$		0.7	5.0	mV
Input Offset Current				0.7	20.0	nA
Input Bias Current				25	100	nA
Input Resistance			1.0	2.0		$M\Omega$
Input Capacitance				3.0		pF
Offset Voltage Adjustment Range				± 25		mV
Large Signal Voltage Gain		$R_L \geq 2k\Omega$, $V_{OUT} = \pm 10V$	25,000	250,000		V/V
Output Resistance				100		Ω
Output Short Circuit Current				± 25		mA
Supply Current				1.9	2.8	mA
Power Consumption				60	85	mW
Transient Response (Voltage Follower, Gain of 1)	Rise Time	$V_{IN} = 20mV$, $C_C = 30pF$ $R_L = 2k\Omega$, $C_L \leq 100pF$		0.3		μs
	Overshoot			5.0		%
Slew Rate (Voltage Follower, Gain of 1)		$R_L \geq 2k\Omega$		0.5		V/ μs
Transient Response (Voltage Follower, Gain of 10)	Rise Time	$V_{IN} = 20mV$, $C_C = 3.5pF$ $R_L = 2k\Omega$, $C_L \leq 100pF$		0.3		μs
	Overshoot			5.0		%
Slew Rate (Voltage Follower, Gain of 10)		$R_L \leq 2k\Omega$, $C_C = 3.5pF$		5.5		V/ μs
The following specifications apply over operating temperature range.						
Input Offset Voltage		$R_S \leq 50k\Omega$		0.8	5.0	mV
Average Input Offset Voltage Drift		$R_S \leq 50k\Omega$		4.0	30	$\mu V/^\circ C$
Input Offset Current					40	nA
Average Input Offset Current Drift		$25^\circ C \leq T_A \leq +70^\circ C$ $0^\circ C \leq T_A \leq +25^\circ C$		0.01 0.02	10.3 0.6	nA/ $^\circ C$
Input Bias Current					200	nA
Input Voltage Range			± 12	± 13		V
Common Mode Rejection Ratio		$R_S \leq 50k\Omega$	70	95		dB
Supply Voltage Rejection Ratio		$R_S \leq 50k\Omega$		15	150	$\mu V/V$
Large Signal Voltage Gain		$R_L \geq 2k\Omega$, $V_{OUT} = \pm 10V$	15,000			V/V
Output Voltage Swing		$R_L \geq 10k\Omega$	± 12	± 14		V
		$R_L \geq 2k\Omega$	± 10	± 13		V
Power Consumption				60	100	mW

5

EQUIVALENT CIRCUIT

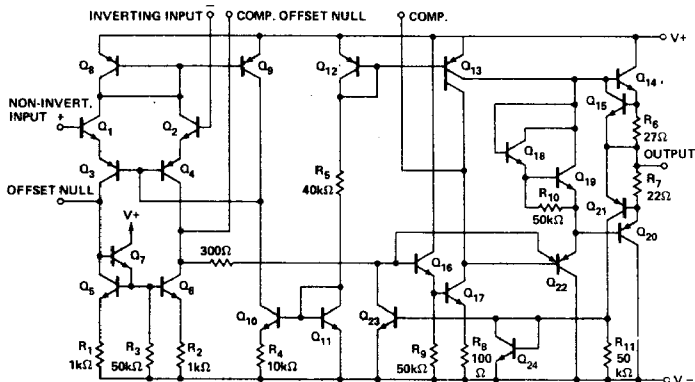

TYPICAL PERFORMANCE CURVES

OPEN LOOP VOLTAGE GAIN AS A FUNCTION OF SUPPLY VOLTAGE

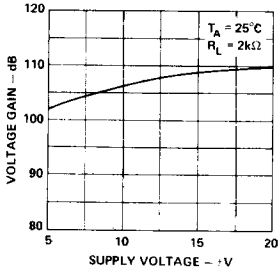

OUTPUT VOLTAGE SWING AS A FUNCTION OF SUPPLY VOLTAGE

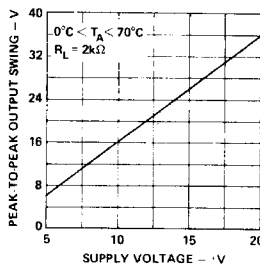

INPUT COMMON MODE VOLTAGE RANGE AS A FUNCTION OF SUPPLY VOLTAGE

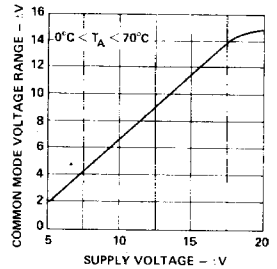

POWER CONSUMPTION AS A FUNCTION OF SUPPLY VOLTAGE

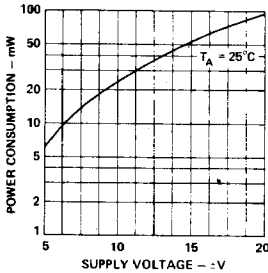

INPUT CURRENT AS A FUNCTION OF AMBIENT TEMPERATURE

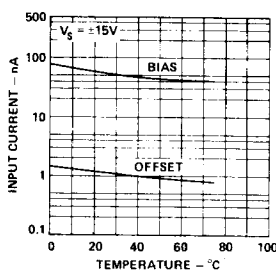

INPUT RESISTANCE AS A FUNCTION OF AMBIENT TEMPERATURE

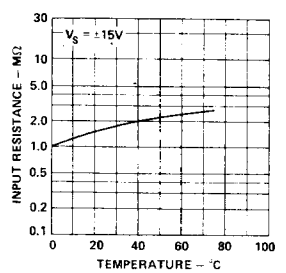

INPUT OFFSET CURRENT AS A FUNCTION OF SUPPLY VOLTAGE

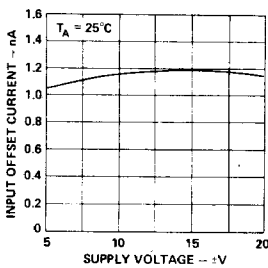

POWER CONSUMPTION AS A FUNCTION OF AMBIENT TEMPERATURE

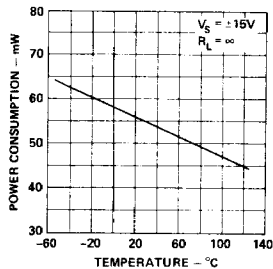

OUTPUT VOLTAGE SWING AS A FUNCTION OF LOAD RESISTANCE

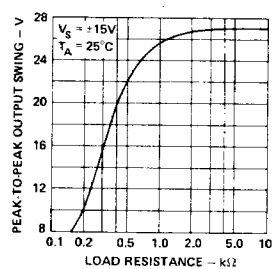

OUTPUT SHORT-CIRCUIT CURRENT AS A FUNCTION OF AMBIENT TEMPERATURE

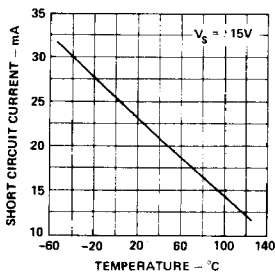

INPUT NOISE VOLTAGE AND CURRENT AS A FUNCTION OF FREQUENCY

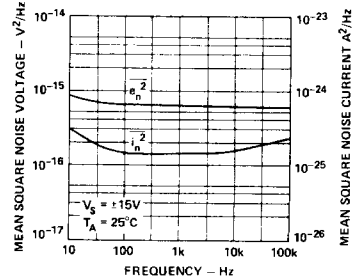

TYPICAL PERFORMANCE CURVES

OPEN LOOP VOLTAGE GAIN AS A FUNCTION OF FREQUENCY

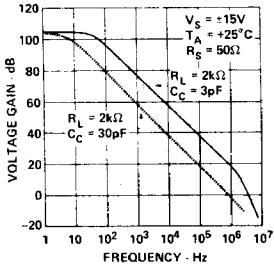

OPEN LOOP PHASE RESPONSE AS A FUNCTION OF FREQUENCY

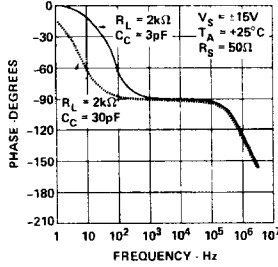

OUTPUT VOLTAGE SWING AS A FUNCTION OF FREQUENCY

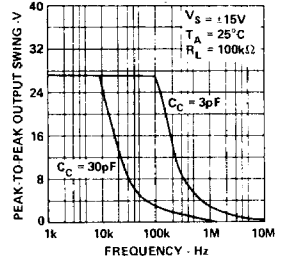

OPEN LOOP VOLTAGE GAIN AS A FUNCTION OF FREQUENCY FOR VARIOUS GAIN/COMPENSATION OPTIONS

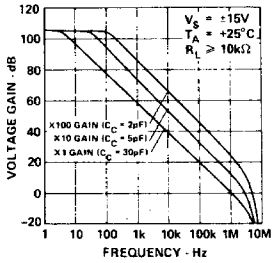

FREQUENCY RESPONSE FOR VARIOUS CLOSED-LOOP GAINS

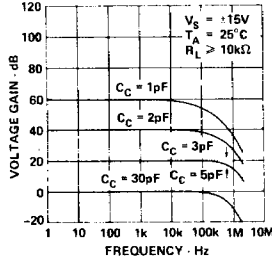

COMPENSATION CAPACITANCE AS A FUNCTION OF CLOSED LOOP VOLTAGE GAIN

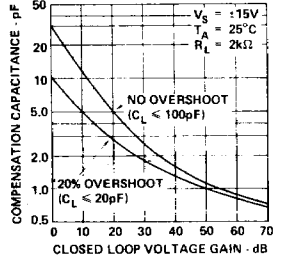

INPUT RESISTANCE, OUTPUT RESISTANCE, AND INPUT CAPACITANCE AS A FUNCTION OF FREQUENCY

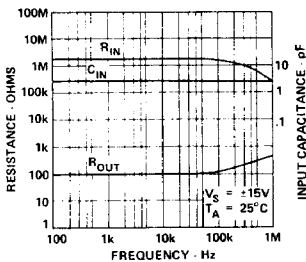

COMMON MODE REJECTION RATIO AS A FUNCTION OF FREQUENCY

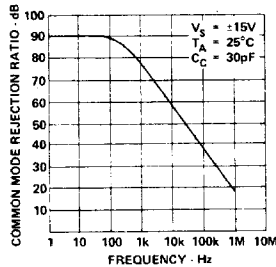

INPUT OFFSET VOLTAGE DRIFT AS A FUNCTION OF TIME

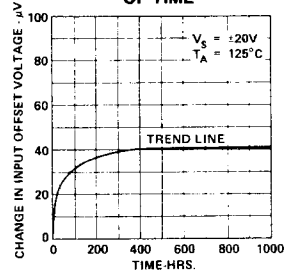

VOLTAGE FOLLOWER TRANSIENT RESPONSE (GAIN OF 1)

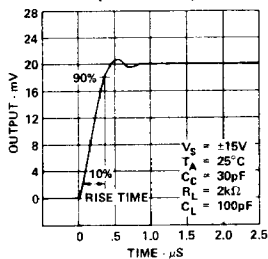

TRANSIENT RESPONSE TEST CIRCUIT

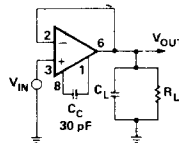

VOLTAGE FOLLOWER LARGE SIGNAL PULSE RESPONSE

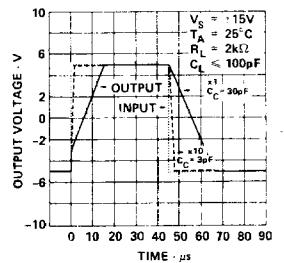

5

TYPICAL PERFORMANCE CURVES

THERMAL RESPONSE OF INPUT OFFSET VOLTAGE TO STEP CHANGE OF CASE TEMPERATURE

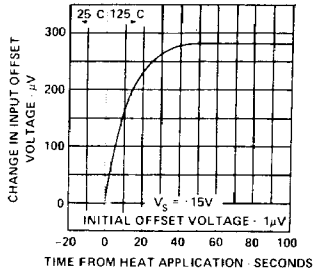

STABILIZATION TIME OF INPUT OFF-SET VOLTAGE FROM POWER TURN-ON

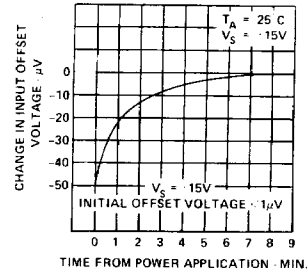

FEED FORWARD COMPENSATION

LARGE SIGNAL FEEDFORWARD TRANSIENT RESPONSE

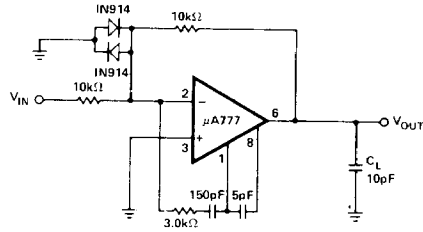
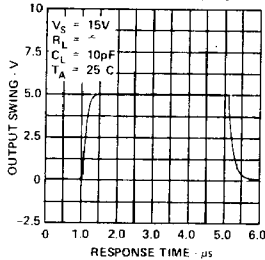

VOLTAGE OFFSET NULL CIRCUIT

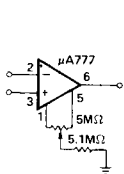

SUGGESTED

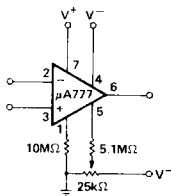

ALTERNATE

GAIN TEST CIRCUIT

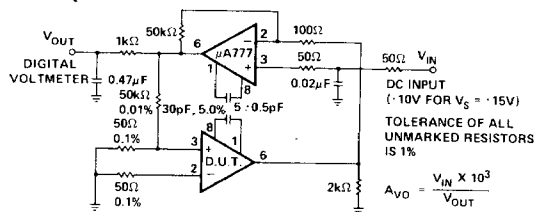

TYPICAL APPLICATIONS

BIAS COMPENSATED LONG TIME INTEGRATOR

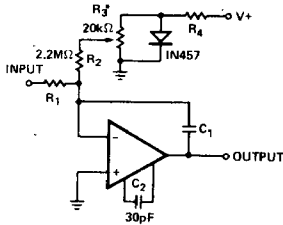

*ADJUST R₃ FOR MINIMUM INTEGRATOR DRIFT

SAMPLE AND HOLD

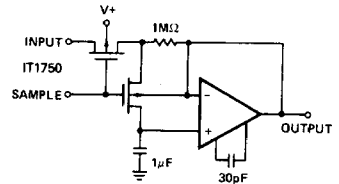

CAPACITANCE MULTIPLIER

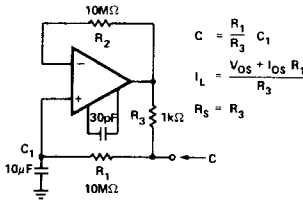

AMPLIFIER FOR CAPACITANCE TRANSDUCERS

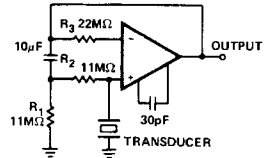

LOW FREQUENCY CUTOFF R₁ X C₁

5

BILATERAL CURRENT SOURCE

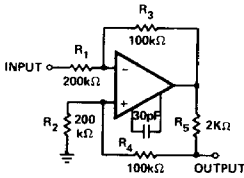

$$I_{OUT} = \frac{R_3 V_{IN}}{R_1 R_5} ; R_1 = R_2 ; R_3 = R_4 + R_5$$

HIGH SLEW RATE POWER AMPLIFIER

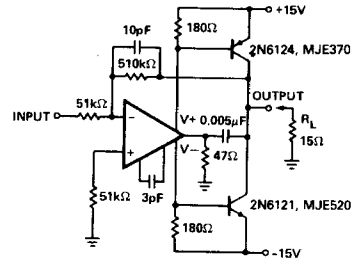

± 100V COMMON MODE RANGE INSTRUMENTATION AMPLIFIER

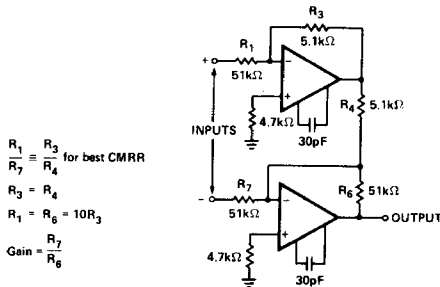

INSTRUMENTATION AMPLIFIER WITH HIGH COMMON MODE REJECTION

