

**XPAK
1310 nm Module
10 Gigabit Pluggable Transceiver
Compatible with XPAK MSA Rev. 2.3**

**V23833-G2104-A001
V23833-G6104-A001
V23833-G6104-A011**

Preliminary Data Sheet

Features

Standards

- Compatible with IEEE Std 802.3ae™-2002
- Compatible with Fibre Channel 10GFC Draft 3.5
- Compatible with XPAK MSA Rev. 2.3

Optical

- IEEE Ethernet: Serial 1310 nm 10GBASE-LR
- T11 Fibre Channel: Serial 1310 nm 1200-SM-LL-L
- 10 Gigabit Fibre Channel: 10.51875 Gbit/s (V23833-G2104-A001)
- 10 Gigabit Ethernet: 10.3125 Gbit/s (V23833-G6104-A0x1)
- Transmission distance up to 10 km¹⁾
- Uncooled directly modulated Distributed Feedback (DFB) laser at 1310 nm
- SC connector, single mode fiber
- Full duplex transmission mode
- Eye safety class 1 (IEC 60825-1:A2)

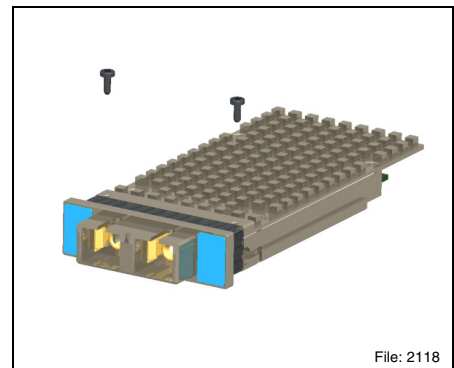
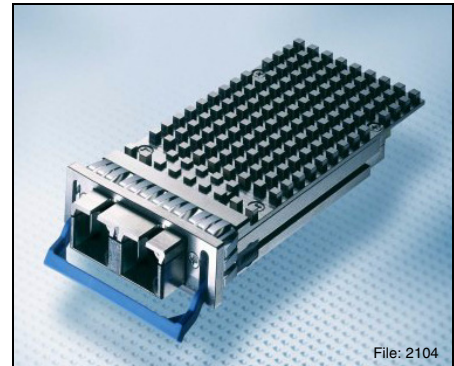

¹⁾ Maximum reach as defined by IEEE. Longer reach possible depending upon link implementation.

Part Number	Standard	De-Latch Mechanism	Connector	Laser Class
V23833-G2104-A001	Fibre Channel	Bail	SC	1
V23833-G6104-A001	Ethernet	Bail	SC	1
V23833-G6104-A011	Ethernet	None	SC	1

- DOM
 - Loss Of Signal from receiver
 - Laser safety alarm (with reset function)
 - Supply voltage monitor (+3.3 V, Adaptable Power Supply)
 - Transmit power
 - Module temperature
 - Received power
 - Transmit bias current monitor

Mechanical

- Mezzanine profile: 2.68" L x 1.42" W x 0.38" H (68.07 mm x 35.99 mm x 9.8 mm)
- Mezzanine module height for PCI card applications and mid-board mounting
- Separated signal/chassis ground (a common signal/chassis ground module version is available upon request)
- Belly-to-belly applications
- De-latch mechanism with low extraction force (V23833-Gxxxx-Ax0x only)
- Built-in heat sink

Electrical

- Hot pluggable
- Power supply: +5.0 V, +3.3 V, Adaptable Power Supply (APS: +1.8 V)
- Total power consumption: 3.3 W typical
- XAUI electrical interface
 - 3.125 Gbit/s Ethernet (V23833-G61xx-xxxx)
 - 3.1875 Gbit/s Fibre Channel (V23833-G21xx-xxxx)
- Management and control via MDIO 2-wire bus
- 70-pin connector

Applications

- 10 Gbit/s Ethernet and Fibre Channel transmission systems for Long Range (LR)
- Integration on PCI card
- Mid-board mounting
- Belly-to-belly for high density applications
- Enterprise and campus network applications
- Storage applications
- Backplane and switch applications
- Core and edge routers
- Aggregation point for lower data rate
- XPAK evaluation kit V23833-G9909-Z001 available upon request

Pin Configuration

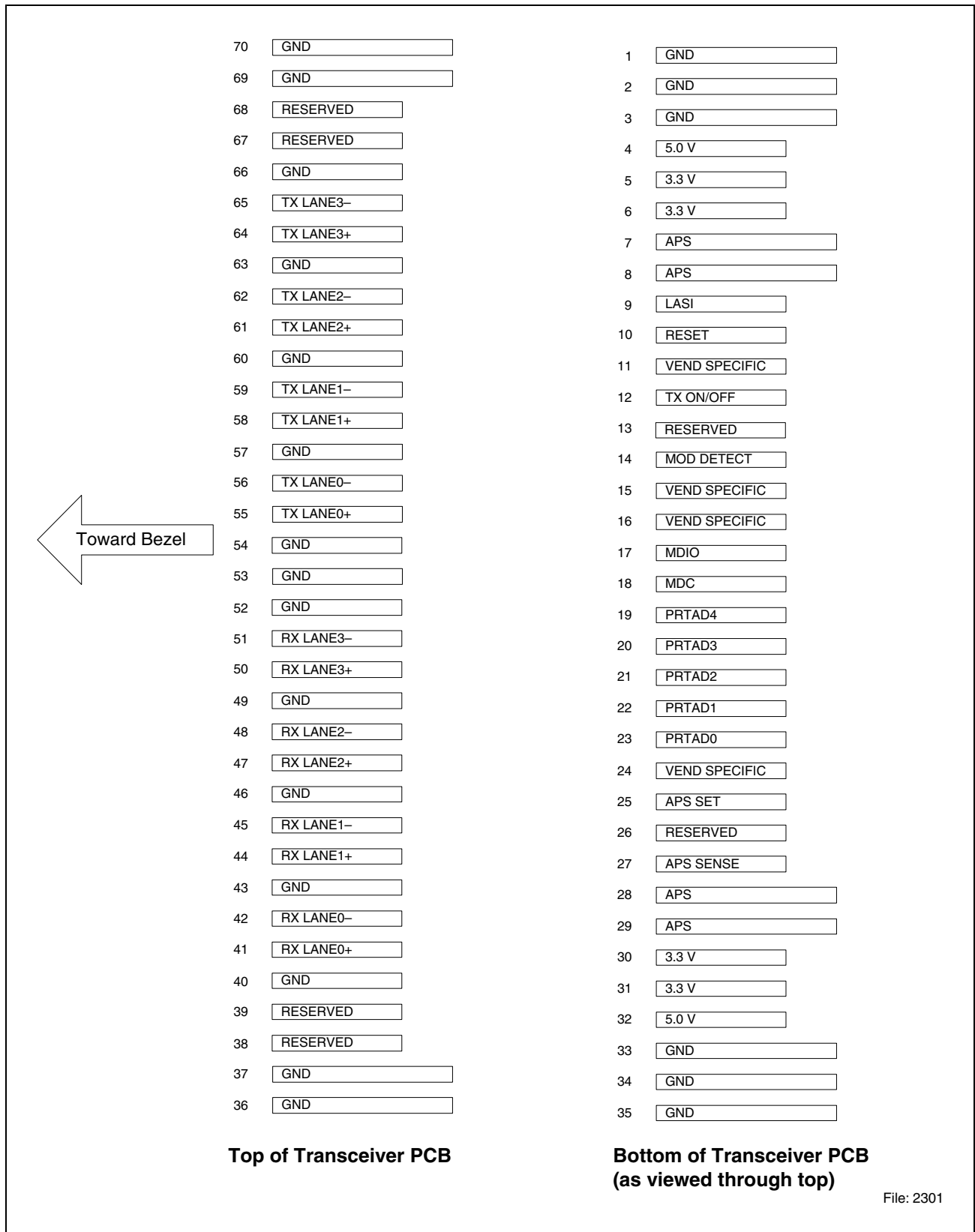

Figure 1 XPAK Transceiver Electrical Pad Layout

Pin Configuration
Connector Pin Assignments

Pin No.	Signal Name
1	GND
2	GND
3	GND
4	+5.0 V DC Power
5	+3.3 V DC Power
6	+3.3 V DC Power
7	APS
8	APS
9	LASI
10	RESET
11	Vendor Specific
12	TX ON/OFF
13	Reserved
14	MOD DETECT
15	Vendor Specific
16	Vendor Specific
17	MDIO
18	MDC
19	PRTAD4
20	PRTAD3
21	PRTAD2
22	PRTAD1
23	PRTAD0
24	Vendor Specific
25	APS SET
26	Reserved
27	APS SENSE
28	APS
29	APS
30	+3.3 V DC Power
31	+3.3 V DC Power
32	+5.0 V DC Power
33	GND
34	GND
35	GND

Pin No.	Signal Name
70	GND
69	GND
68	Reserved
67	Reserved
66	GND
65	TX LANE3-
64	TX LANE3+
63	GND
62	TX LANE2-
61	TX LANE2+
60	GND
59	TX LANE1-
58	TX LANE1+
57	GND
56	TX LANE0-
55	TX LANE0+
54	GND
53	GND
52	GND
51	RX LANE3-
50	RX LANE3+
49	GND
48	RX LANE2-
47	RX LANE2+
46	GND
45	RX LANE1-
44	RX LANE1+
43	GND
42	RX LANE0-
41	RX LANE0+
40	GND
39	Reserved
38	Reserved
37	GND
36	GND

Pin Configuration
Pin Description

Signal Name	Level	I/O	Pin No.	Description
Management and Monitoring Ports				
MDIO	Open Drain	I/O	17	Management Data I/O. Requires external 10 - 22 kΩ pull-up to 1.8 V on host.
MDC	1.2 V CMOS	I	18	Management Data Clock Input
PRTAD4	1.2 V CMOS	I	19	Port Address Input bit 4
PRTAD3	1.2 V CMOS	I	20	Port Address Input bit 3
PRTAD2	1.2 V CMOS	I	21	Port Address Input bit 2
PRTAD1	1.2 V CMOS	I	22	Port Address Input bit 1
PRTAD0	1.2 V CMOS	I	23	Port Address Input bit 0
LASI	Open Drain	O	9	Link Alarm Status Interrupt Output. Open Drain Compatible Output with 10 - 20 kΩ pull-up on host. Logic high = Normal Operation Logic low = Status Flag Triggered
RESET	Open Drain	I	10	Reset Input. Open Drain Compatible Input with 10 kΩ pull-up to APS internal to transceiver. Logic high = Normal Operation Logic low = RESET Note: 1.8 V is APS
Vendor Specific			11,15,16,24	Vendor Specific Pins. Leave unconnected when not used.
TX ON/OFF	Open Drain	I	12	TX ON/OFF Input. Open Drain Compatible Input with 10 kΩ pull-up to APS internal to transceiver. Logic high = Transmitter On Logic low = Transmitter Off Note: 1.8 V is APS
MOD DETECT		O	14	Pulled low inside transceiver through a 1 kΩ resistor to Ground

Pin Configuration
Pin Description (cont'd)

Signal Name	Level	I/O	Pin No.	Description
Transmit Functions				
Reserved		I	68	Reserved For Future Use
Reserved		I	67	Reserved For Future Use
TX LANE 3–	AC-coupled, Internally biased differential XAUI	I	65	Module XAUI Input Lane 3–
TX LANE 3+		I	64	Module XAUI Input Lane 3+
TX LANE 2–		I	62	Module XAUI Input Lane 2–
TX LANE 2+		I	61	Module XAUI Input Lane 2+
TX LANE 1–		I	59	Module XAUI Input Lane 1–
TX LANE 1+		I	58	Module XAUI Input Lane 1+
TX LANE 0–		I	56	Module XAUI Input Lane 0–
TX LANE 0+		I	55	Module XAUI Input Lane 0+
Receive Functions				
Reserved		O	38	Reserved For Future Use
Reserved		O	39	Reserved For Future Use
RX LANE 0+	AC-coupled, Internally biased differential XAUI	O	41	Module XAUI Output Lane 0+
RX LANE 0–		O	42	Module XAUI Output Lane 0–
RX LANE 1+		O	44	Module XAUI Output Lane 1+
RX LANE 1–		O	45	Module XAUI Output Lane 1–
RX LANE 2+		O	47	Module XAUI Output Lane 2+
RX LANE 2–		O	48	Module XAUI Output Lane 2–
RX LANE 3+		O	50	Module XAUI Output Lane 3+
RX LANE 3–		O	51	Module XAUI Output Lane 3–

Pin Configuration
Pin Description (cont'd)

Signal Name	Level	I/O	Pin No.	Description
DC Power				
GND	0 V DC	I	1,2,3,33,34,35,36,37,40,43,46,49,52,53,54,57,60,63,66,69,70	Ground connection for signal ground on the module
APS	+1.8 V	I	7,8,28,29	Input from Adaptive Power Supply
APS SENSE	+1.8 V	O	27	APS Sense Output. Connected to the APS input inside transceiver.
APS SET	GND	I	25	Feedback input from APS. Connected to GND through a zero Ω resistor inside the transceiver.
3.3 V	+3.3 V DC	I	5,6,30,31	DC Power Input, +3.3 V DC, Nominal
5.0 V	+5.0 V DC	I	4,32	DC Power Input, +5.0 V DC, Nominal
Reserved			26	Reserved for APD. Do not connect.
Reserved			13	Reserved. Do not connect.

Description

System Block Diagram (10 Gbit/s Ethernet)

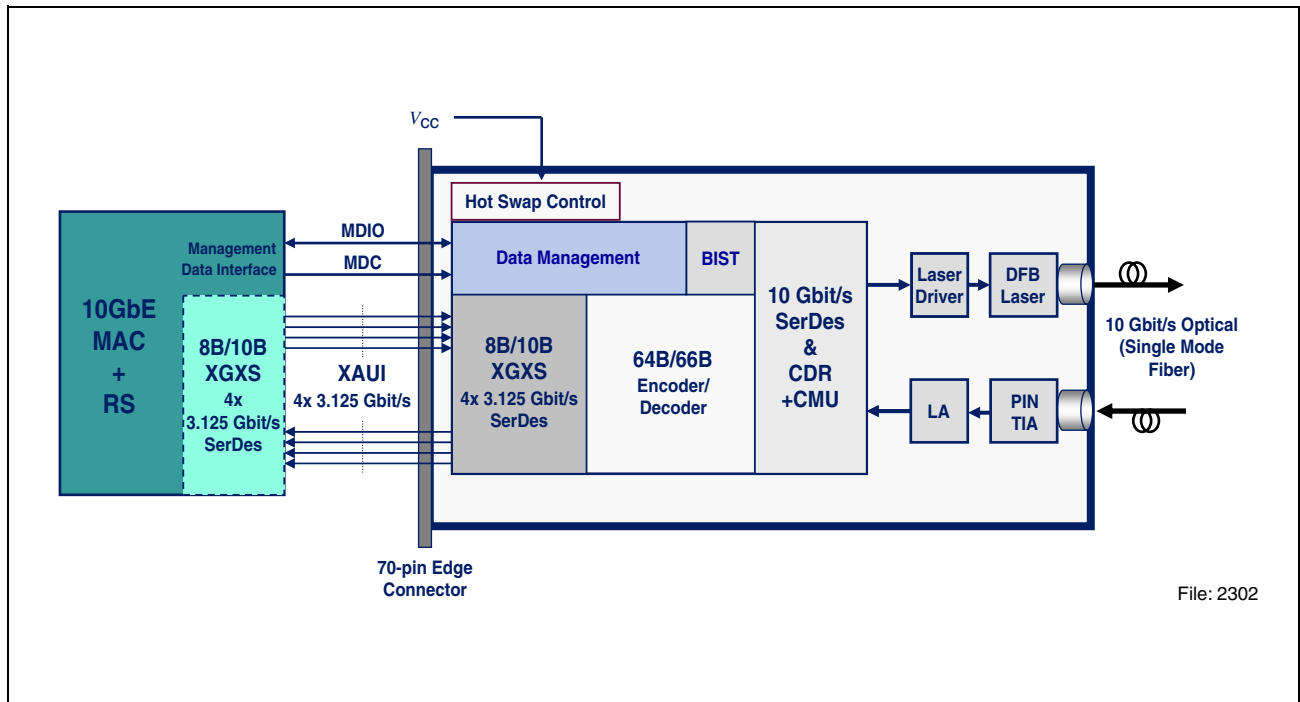

File: 2302

Figure 2

Optical Interface Standard Specifications

- IEEE Std 802.3ae™-2002 clause 52, 10GBASE-LR
- Fibre Channel 10GFC Draft 3.5, 1200-SM-LL-L
- XPAK MSA 2.3

Fiber Type	Differential Group Delay Maximum (ps)	Operating Range (meters) ¹⁾
B1.1 SMF	10	2 to 10,000
B1.3 SMF	10	2 to 10,000

¹⁾ Operating range as defined by IEEE and Fibre Channel standards. Longer reach possible depending upon link implementation.

Electrical Interface Standard Specifications

- IEEE Std 802.3ae™-2002 clause 45 & 47
- XPAK MSA 2.3

Environment: Thermal Management Recommendations

Operating air inlet temperature:	0°C - 50°C
Operating Airflow:	3 m/s maximum defined per XPAK MSA
Operating Humidity:	0% - 95% RH non-condensing

Module can withstand and operate with case temperature of 75°C for up to 96 hrs/yr. Transceiver requires airflow across cooling fins. Maximum airflow required per XPAK MSA is 3 m/s. Actual airflow required to provide adequate cooling for module is 1 m/s with a maximum air inlet temperature of 50°C. A maximum case temperature of 70°C must be observed.

Fibers and Connectors

The transceiver has SC receptacles for both Tx and Rx. The transceiver is designed for single mode SC cables, 0° polished endface (PC).

70-pin Connector

The module interface connector is a 70-pin, printed circuit board edge connection with a 0.5 mm pitch. The appropriate mating connector for the customer PCB is a 70-pin SMT, dual row, right angled, edge connector, 0.5 mm pitch (TycoAmp part number 1367337-1, Molex part number 74441-0003 or equivalent).

Cage Requirement

The cage assembly required to mount the XPAK module is defined by the MSA. There are two cage designs for the module, tall and mezzanine profile. For correct operation and EMI design the correct cage size must be selected for the appropriate module. Alternatively a flangeless cage design is specified where there is limited size. A sufficient EMI gasket that connects from the cage to the face plate must be fitted. The mechanical design must ensure that no air gaps exist between the cage and the face plate while the module is plugged in.

Recommended XPAK rail assembly, Molex part number 74732-0200.

Description
DOM Parameters

Parameter	Values			Unit
	min.	typ.	max.	
Transceiver Temperature Monitor Accuracy ¹⁾			±5	°C
Transmit Bias Current Monitor Accuracy ²⁾			±10	%
Transmit Power Monitor Accuracy ³⁾			±3	dB
Receive Power Monitor Accuracy ³⁾			±3	dB

¹⁾ 0 to 70°C case temperature.

²⁾ 0 to 12.5 mA.

³⁾ 0 to 6.5 mW.

Regulatory Compliance

Feature	Standard	Comments
ESD: Electrostatic Discharge to the Electrical Pins (HBM)	EIA/JESD22-A114-B (MIL-STD 883D Method 3015.7)	Class 1a (> 500 V)
Immunity: Against Electrostatic Discharge (ESD) to the Module Receptacle	EN 61000-4-2 IEC 61000-4-2	Discharges ranging from ±2 kV to ±15 kV to the front end / faceplate / receptacle cause no damage to module (under recommended conditions).
Immunity: Against Radio Frequency Electromagnetic Field	EN 61000-4-3 IEC 61000-4-3	With a field strength of 10 V/m, noise frequency ranges from 10 MHz to 2 GHz. No effect on module performance between the specification limits.
Emission: Electromagnetic Interference (EMI)	FCC 47 CFR Part 15, Class B EN 55022 Class B CISPR 22	Noise frequency range: 30 MHz to 40 GHz Radiated emission does not exceed specified limits when measured inside a shielding enclosure with MSA conform cutout.

Technical Data
Absolute Maximum Ratings

Parameter	Symbol	Limit Values		Unit
		min.	max.	
Storage Ambient Temperature ¹⁾	T_{As}	-20	85	°C
Operating Ambient Temperature ¹⁾	T_{Ao}	0	65	°C
Operating Case Temperature ¹⁾	T_{Co}	0	80	°C
Supply Voltage +5.0 V	V_5	0	6	V
Supply Voltage +3.3 V	V_3	0	4	V
Supply Voltage APS	V_{aps}	0	2	V
Static Discharge Voltage, All Pins	ST_d		500	V
Average Receive Optical Power	$Rx_{P_{max}}$		1.5	dBm

¹⁾ Non condensing.

Exceeding any one of these values may permanently destroy the device.

Recommended Operating Conditions

Parameter	Symbol	Values			Unit
		min.	typ.	max.	
Operating Case Temperature ¹⁾	T_C	0		70	°C
Transceiver Total Power Consumption	P		3.3	3.5	W
Supply Voltage +5.0 V	V_{CC5}	4.75	5.0	5.25	V
Supply Current +5.0 V	I_{CC5}		50		mA
Supply Voltage +3.3 V	V_{CC3}	3.14	3.3	3.47	V
Supply Current +3.3 V	I_{CC3}		550		mA
Supply Voltage APS	$V_{CC_{aps}}$	1.746	1.8	1.854	V
Supply Current APS	$I_{CC_{aps}}$		700		mA

¹⁾ Worst case thermal location, see **Figure 12**.
See also **Environment: Thermal Management Recommendations**.

Optical Characteristics

($V_{CC5} = 4.75\text{ V to }5.25\text{ V}$, $V_{CC3} = 3.14\text{ V to }3.47\text{ V}$, $V_{CC\text{aps}} = 1.746\text{ V to }1.854\text{ V}$, $T_C = 0^\circ\text{C to }70^\circ\text{C}$)

Parameter	Symbol	Values			Unit
		min.	typ.	max.	

Transmitter

Launch Power in OMA minus TDP	$P_{O\text{-OMA}}$	-6.2			dBm
Average Launch Power	$P_{O\text{-Avg}}$	-8.2	-1	0.5	dBm
Center Wavelength Range	$\lambda_{C\text{-Tx}}$	1290	1310	1330	nm
Spectral Width (-20 dB)	σ_I		0.5	0.6	nm
Side Mode Suppression Ratio	SMSR	30			dB
Extinction Ratio	ER	3.5	5		dB
Relative Intensity Noise ₁₂ OMA	RIN			-128	dB/Hz
Optical Modulation Amplitude (OMA)	OMA	-5.2			dBm
Transmitter and Dispersion Penalty	TDP			3.2	dB
Average Launch Power of OFF Transmitter	$P_{O\text{-OFF}}$			-30	dBm
Optical Return Loss Tolerance	ORL_T			12	dB
Transmitter Reflectance	REF_{TX}			-12	dB
Eye Mask Definition	According to IEEE and Fibre Channel				

Receiver

Stressed Receiver Sensitivity	$P_{IN\text{-S}}$			-10.3	dBm
Sensitivity in OMA ¹⁾	P_{IN}			-12.6	dBm
Average Receive Power	$P_{IN\text{-max}}$			0.5	dBm
Loss Of Signal Assert Level	P_{LOSa}		-17	-13	dBm
Loss Of Signal Hysteresis	P_{LOS_h}	1	2	4	dB
Receiver Reflectance	REF_{Rx}			-12	dB
Center Wavelength Range	$\lambda_{C\text{-Rx}}$	1260		1355	nm
Electrical 3 dB Upper Cut-off Frequency	$3dB_{CO}$			12.3	GHz

¹⁾ Receiver sensitivity, which is defined for an ideal input signal is informative only.

Electrical DC Characteristics
 $(V_{CC5} = 4.75 \text{ V to } 5.25 \text{ V}, V_{CC3} = 3.14 \text{ V to } 3.47 \text{ V}, V_{CC\text{aps}} = 1.746 \text{ V to } 1.854 \text{ V}, T_C = 0^\circ\text{C to } 70^\circ\text{C})$

Parameter	Symbol	Values			Unit
		min.	typ.	max.	

**1.2 V CMOS (1.8 V CMOS Compatible¹⁾) I/O DC Characteristics
(PRTAD; LASI; RESET; TX_ONOFF)**

External Pull-up Resistor for Open Drain	R_{pullup}	10		22	k Ω
Output High Voltage ²⁾	V_{oh}	1			V
Output Low Voltage ²⁾	V_{ol}			0.15	V
Input High Voltage	V_{ih}	0.84		1.854	V
Input Low Voltage	V_{il}			0.36	V
Input Pull-down Current ³⁾	I_{pd}	20		120	μA

**XAUI I/O DC Characteristics
(TXLANE[0..3]; RXLANE[0..3])**

Differential Input Amplitude (pk-pk) ⁴⁾	$V_{\text{in_xaui}}$	200		2500	mV
Differential Output Amplitude (pk-pk) ⁴⁾	$V_{\text{out_xaui}}$	800		1600	mV

**MDIO I/O DC Characteristics
(MDIO; MDC)**

Output Low Voltage ⁵⁾	V_{OL}	-0.3		0.2	V
Output Low Current	I_{OL}			4	mA
Input High Voltage	V_{IH}	0.84		1.854	V
Input Low Voltage	V_{IL}	-0.3		0.36	V
Pull-up Supply Voltage	V_{PU}	1.746	1.8	1.854	V
Input Capacitance	C_{IN}			10	pF
Load Capacitance	C_{LOAD}			470	pF
External Pull-up Resistance	R_{LOAD}	200			Ω

¹⁾ For 1.8 V CMOS $V_{\text{oh}} = 1.65 \text{ V min.}$, $V_{\text{ol}} = 0.15 \text{ V max.}$, $V_{\text{ih}} = 1.17 \text{ V min.}$, $V_{\text{il}} = 0.63 \text{ V max.}$

²⁾ $R_{\text{pull-up}} = 10 \text{ k}\Omega \text{ to } 1.8 \text{ V.}$

³⁾ $V_{\text{in}} = 1.8 \text{ V.}$

⁴⁾ AC coupled.

⁵⁾ $I_{\text{OL}} = 100 \mu\text{A.}$

Electrical AC Characteristics

 ($V_{CC5} = 4.75\text{ V to }5.25\text{ V}$, $V_{CC3} = 3.14\text{ V to }3.47\text{ V}$, $V_{CC\text{aps}} = 1.746\text{ V to }1.854\text{ V}$, $T_C = 0^\circ\text{C to }70^\circ\text{C}$)

Parameter	Symbol	Values			Unit
		min.	typ.	max.	

**XAUI Input AC Characteristics
(TXLANE[0..3])**

Baud Rate Fibre Channel Ethernet	R_{XAUIIN}		3.1875 3.125		Gbit/s
Baud Rate Tolerance	$R_{TOLXAUI}$	-100		100	ppm
Differential Input Impedance	Z_{INXAUI}	80	100	120	Ω
Differential Return Loss ¹⁾	$ S_{11} $	10			dB
Input Differential Skew ²⁾	t_{SKEWIN}			75	ps
Jitter Amplitude Tolerance ³⁾	$J_{XAUITOL}$				

**XAUI Output AC Characteristics
(RXLANE[0..3])**

Baud Rate Fibre Channel Ethernet	$R_{XAUIOUT}$		3.1875 3.125		Gbit/s
Baud Rate Variation	$R_{XAUIVAR}$	-100		100	ppm
Rise and Fall Times 20% - 80%	t_r, t_f	40		100	ps
Output Differential Skew	$t_{SKEWOUT}$			15	ps
Output Differential Impedance	$Z_{OUTXAUI}$	80	100	120	Ω
Differential Output Return Loss ¹⁾	$ S_{22} $	10			dB
Total Jitter ⁴⁾	TJ_{XAUI}			0.35	UI
Deterministic Jitter ⁴⁾	DJ_{XAUI}			0.17	UI

Power-On Reset AC Characteristics

Power-On Reset and TX_ONOFF Characteristics	According to XENPAK MSA Issue 3.0 Draft 4.0, 2002-9-9				
--	--	--	--	--	--

Electrical AC Characteristics Characteristics (cont'd)

($V_{CC5} = 4.75\text{ V to }5.25\text{ V}$, $V_{CC3} = 3.14\text{ V to }3.47\text{ V}$, $V_{CC\text{aps}} = 1.746\text{ V to }1.854\text{ V}$, $T_C = 0^\circ\text{C to }70^\circ\text{C}$)

Parameter	Symbol	Values			Unit
		min.	typ.	max.	

MDIO I/O AC Characteristics (MDIO; MDC)

MDIO Data Hold Time	t_{HOLD}	10			ns
MDIO Data Setup Time	t_{SU}	10			ns
Delay from MDC Rising Edge to MDIO Data Change	t_{DELAY}			300	ns
MDC Clock Rate	f_{MAX}			2.5	MHz

¹⁾ 100 MHz to 2.5 GHz.

²⁾ At crossing point.

³⁾ Per IEEE Std 802.3ea.

⁴⁾ At near-end. No pre-equalization. 1 UI = 320 ps.

Mechanical Characteristics

Parameter	Symbol	Values			Unit
		min.	typ.	max.	
Module Retention Force (latch strength)	F_{RET}		200		N
Module Insertion Force	F_{IN}		40		N
Module Extraction Force (with kick-out)	$F_{\text{EXT-K}}$		16		N
Module Extraction Force (without kick-out)	F_{EXT}		25		N
0-80 UNF Screw Torque ¹⁾	$\tau_{\text{0-80 UNF}}$			10	cNm

¹⁾ Two 0-80 UNF screws are used to secure the XPAK module (no bail de-latch version V23833-Gxxxx-Ax1x) in the cage. The XPAK module is supplied with the screws assembled, and removal is required prior to insertion into the cage.

Eye Safety

This laser based single mode transceiver is a Class 1 product. It complies with IEC 60825-1 and FDA 21 CFR 1040.10 and 1040.11 except for deviations pursuant to Laser Notice 50, dated July 26, 2001.

CLASS 1 LASER PRODUCT

To meet laser safety requirements the transceiver shall be operated within the Absolute Maximum Ratings.

Attention: All adjustments have been made at the factory prior to shipment of the devices. No maintenance or alteration to the device is required. Tampering with or modifying the performance of the device will result in voided product warranty.

Note: Failure to adhere to the above restrictions could result in a modification that is considered an act of “manufacturing”, and will require, under law, recertification of the modified product with the U.S. Food and Drug Administration (ref. 21 CFR 1040.10 (i)).

Laser Data

Wavelength	1310 nm
Accessible Emission Limit (as defined by IEC: 7 mm aperture at 14 mm distance)	15.6 mW
Beam divergence (full angle)	11°

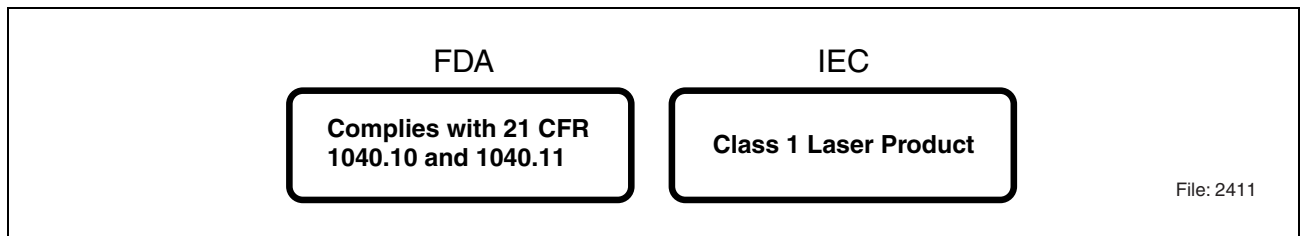

Figure 3 Required Labels

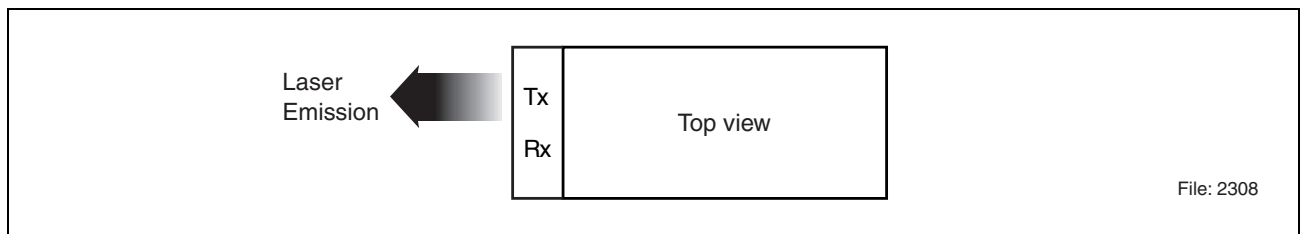

Figure 4 Laser Emission

Application Notes
NVRAM Register Contents

Address		Group	XENPAK MSA 3.0	Value		Comment
Dec	Hex		Definition	Dec	Hex	
32775	8007	Header	XENPAK MSA version supported	30	1E	Rev. 3.0
32776	8008		NVR size in bytes	1	1	256
32777	8009			0	0	
32778	800A		Number of bytes used	0	0	181
32779	800B			181	B5	
32780	800C		Basic field address	11	B	B
32781	800D		Customer field address	119	77	77
32782	800E		Vendor field address	167	A7	A7
32783	800F		Extended vendor field address	0	0	0
32784	8010			0	0	0
32785	8011		Reserved	0	0	0
32786	8012		Basic	Transceived type	4	4
32787	8013	Connector		1	1	SC
32788	8014	Encoding		1	1	NRZ
32789	8015	Bit rate		40	28	10313
32790	8016			73	49	
32791	8017	Protocol		1	1	10GBE
32792	8018	Standards compliance codes		2	2	LR
32793	8019			0	0	not used
32794	801A			0	0	not used
32795	801B			0	0	not used
32796	801C			0	0	not used
32797	801D			0	0	not used
32798	801E			0	0	not used
32799	801F			0	0	not used
32800	8020			0	0	not used
32801	8021			0	0	not used
32802	8022	Range	3	3	10 km	
32803	8023		232	E8		

NVRAM Register Contents (cont'd)

Address		Group	XENPAK MSA 3.0	Value		Comment
Dec	Hex		Definition	Dec	Hex	
32804	8024	Basic	Fiber type	32	20	SM
32805	8025			0	0	
32806	8026		Wavelength channel 0	1	1	1310 nm
32807	8027			255	FF	
32808	8028			184	B8	
32809	8029		Wavelength channel 1	0	0	not used
32810	802A			0	0	not used
32811	802B			0	0	not used
32812	802C		Wavelength channel 2	0	0	not used
32813	802D			0	0	not used
32814	802E			0	0	not used
32815	802F		Wavelength channel 3	0	0	not used
32816	8030			0	0	not used
32817	8031			0	0	not used
32818	8032		Package OUI	1	1	00-0A-CB
32819	8033			67	43	
32820	8034			76	4C	
32821	8035			32	20	
32822	8036		Vendor OUI	3	3	00-13-19
32823	8037			34	22	
32824	8038			96	60	
32825	8039			0	0	
32826	803A		Vendor name	73	49	I
32827	803B			78	4E	N
32828	803C			70	46	F
32829	803D			73	49	I
32830	803E			78	4E	N
32831	803F			69	45	E
32832	8040			79	4F	O
32833	8041			78	4E	N

NVRAM Register Contents (cont'd)

Address		Group	XENPAK MSA 3.0	Value		Comment	
Dec	Hex		Definition	Dec	Hex		
32834	8042	Basic	Vendor name	32	20		
32835	8043			70	46	F	
32836	8044			79	4F	O	
32837	8045			32	20		
32838	8046			71	47	G	
32839	8047			109	6D	m	
32840	8048			98	62	b	
32841	8049			72	48	H	
32842	804A			Vendor part number	86	56	V
32843	804B		50		32	2	
32844	804C		51		33	3	
32845	804D		56		38	8	
32846	804E		51		33	3	
32847	804F		51		33	3	
32848	8050		45		2D	-	
32849	8051		71		47	G	
32850	8052		1)		1)	1)	
32851	8053		48		31	1	
32852	8054		48		30	0	
32853	8055		53		34	4	
32854	8056		65		41	A	
32855	8057		48		30	0	
32856	8058		2)		2)	2)	
32857	8059		49		31	1	
32858	805A		Vendor revision		66	42	B
32859	805B				50	32	2

NVRAM Register Contents (cont'd)

Address		Group	XENPAK MSA 3.0	Value		Comment	
Dec	Hex		Definition	Dec	Hex		
32860	805C	Basic	Vendor serial number	80	50		
32861	805D			80	50		
32862	805E			80	50		
32863	805F			80	50		
32864	8060			80	50		
32865	8061			80	50		
32866	8062			80	50		
32867	8063			80	50		
32868	8064			80	50		
32869	8065			80	50		
32870	8066			80	50		
32871	8067			80	50		
32872	8068			80	50		
32873	8069			80	50		
32874	806A			80	50		
32875	806B			80	50		
32876	806C			Year code			
32877	806D						
32878	806E						
32879	806F						
32880	8070	Month code					
32881	8071						
32882	8072	Day code					
32883	8073						
32884	8074	Lot code					
32885	8075						
32886	8076	5 V stressed environment reference	1	1	250 mA		
32887	8077	3.3 V stressed environment reference	1	1	500 mA		
32888	8078	APS stressed environment reference	2	2	750 mA		

NVRAM Register Contents (cont'd)

Address		Group	XENPAK MSA 3.0	Value		Comment
Dec	Hex		Definition	Dec	Hex	
32889	8079	Basic	Nominal APS voltage	20	14	+1.8 V
32890	807A		DOM capability	195	C3	not default
32891	807B		Optional capability	0	0	none
32892	807C		reserved	0	0	
32893	807D		Basic checksum			
32894	807E		Customer area			
to 32941	to 80AD					
32942	80AE		Vendor specific			
to 33030	to 8106					

- 1) V23833-G2104-A001: Dec = 50, Hex = 32, Comment = 2
 V23833-G6104-A001: Dec = 54, Hex = 36, Comment = 6
 V23833-G6104-A011: Dec = 54, Hex = 36, Comment = 6
- 2) V23833-G2104-A001: Dec = 48, Hex = 30, Comment = 0
 V23833-G6104-A001: Dec = 48, Hex = 30, Comment = 0
 V23833-G6104-A011: Dec = 49, Hex = 31, Comment = 1

PCB Cage Footprints

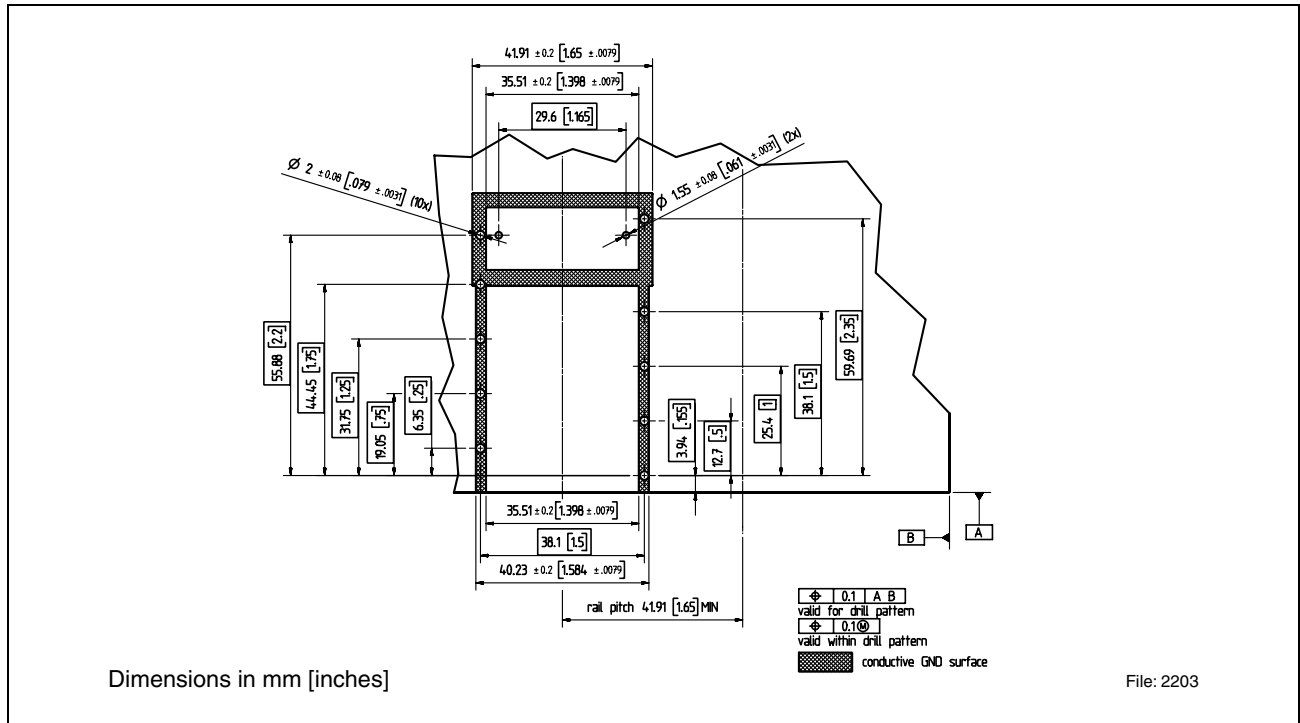

Figure 5 Standard Mounting

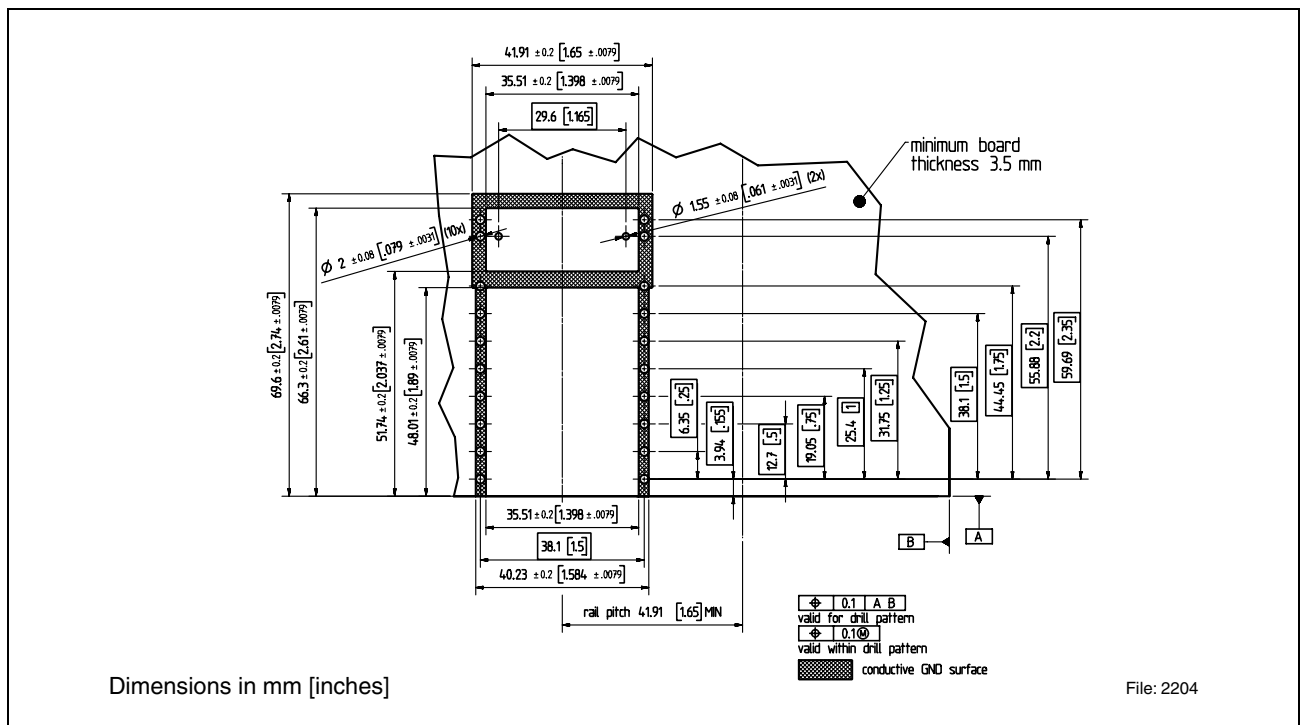

Figure 6 Belly-to-Belly Mounting

Host Board Layouts

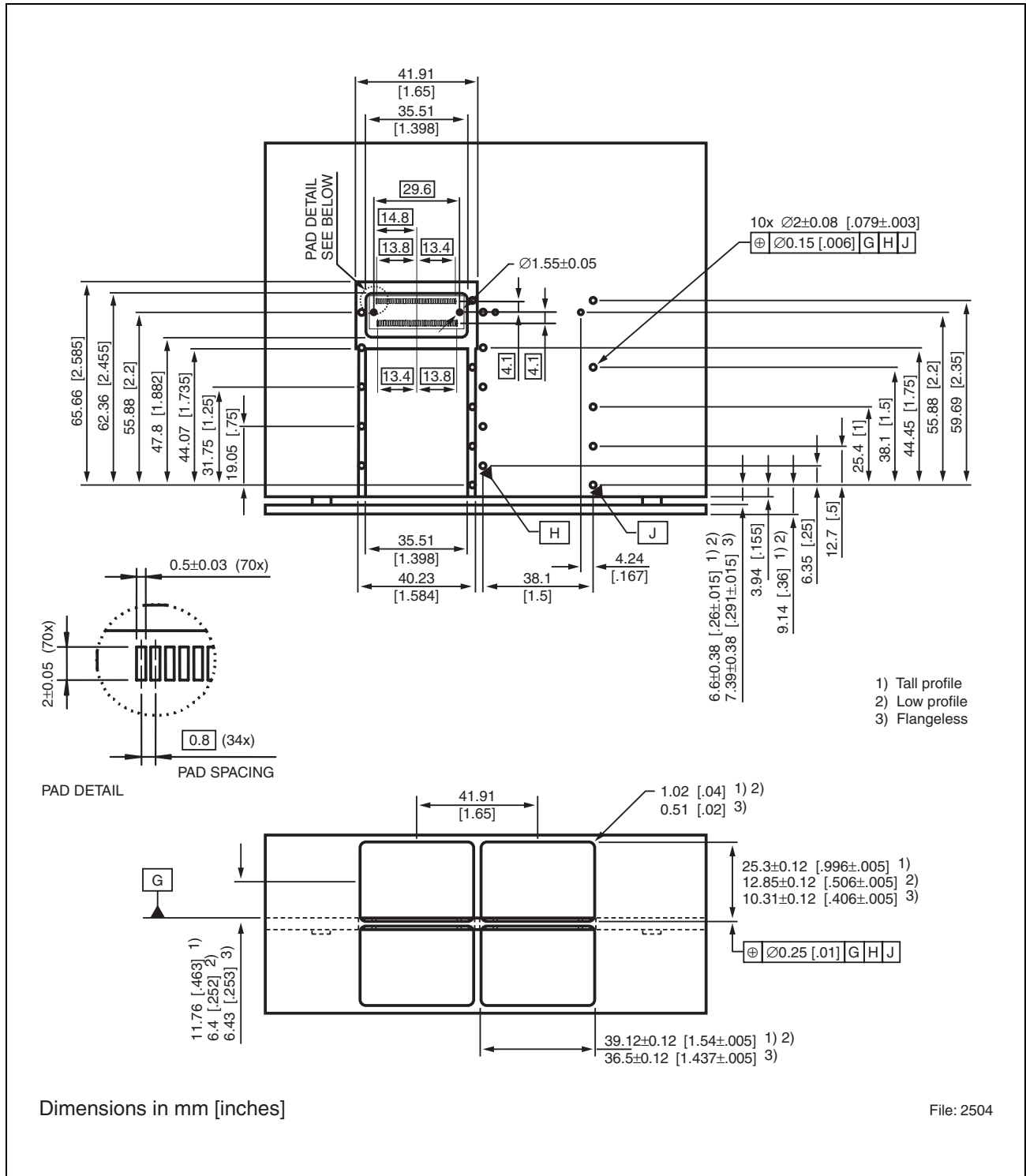

Figure 7 Host PCB, Board Connector Layout and Bezel Opening

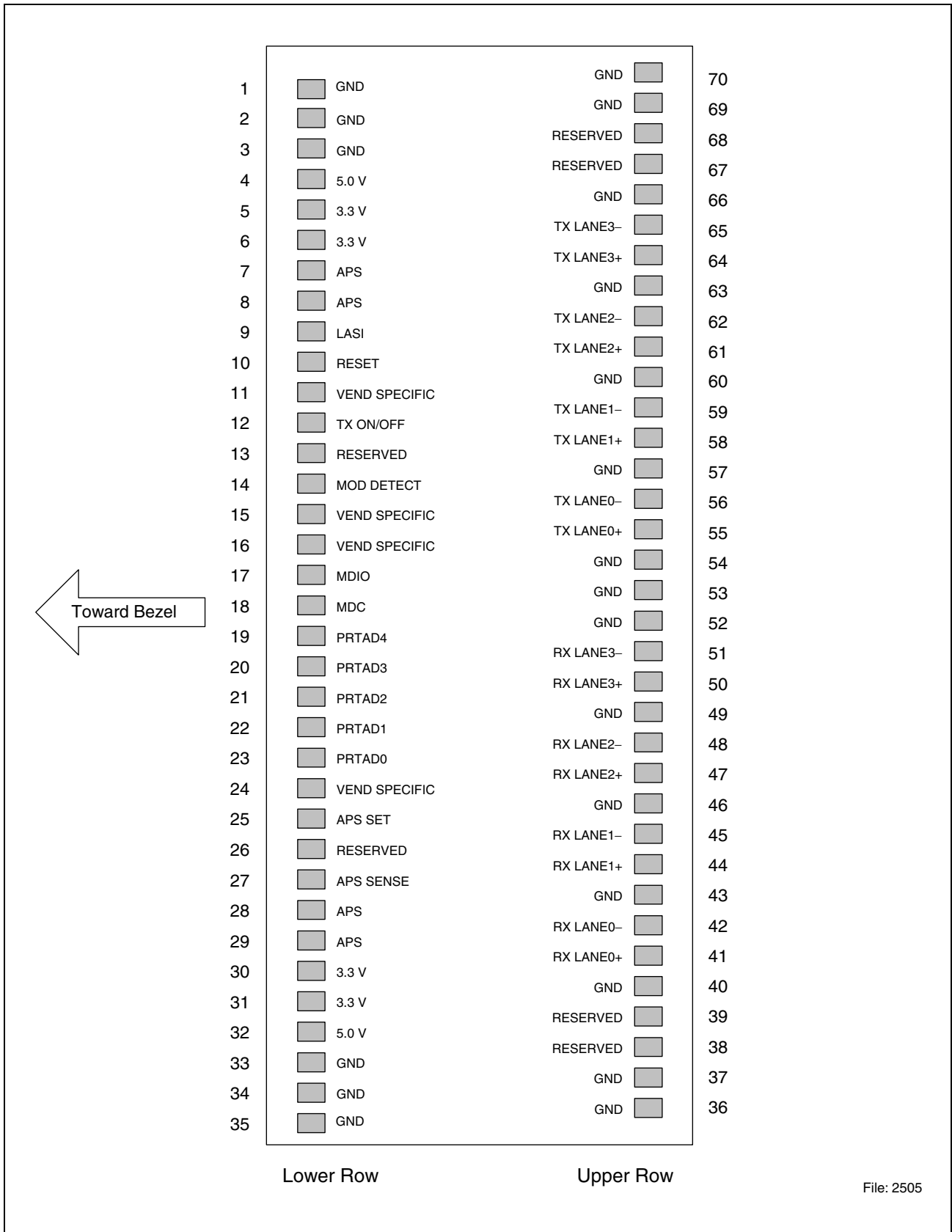

Figure 8 Host Board Pad Layout

Package Outlines

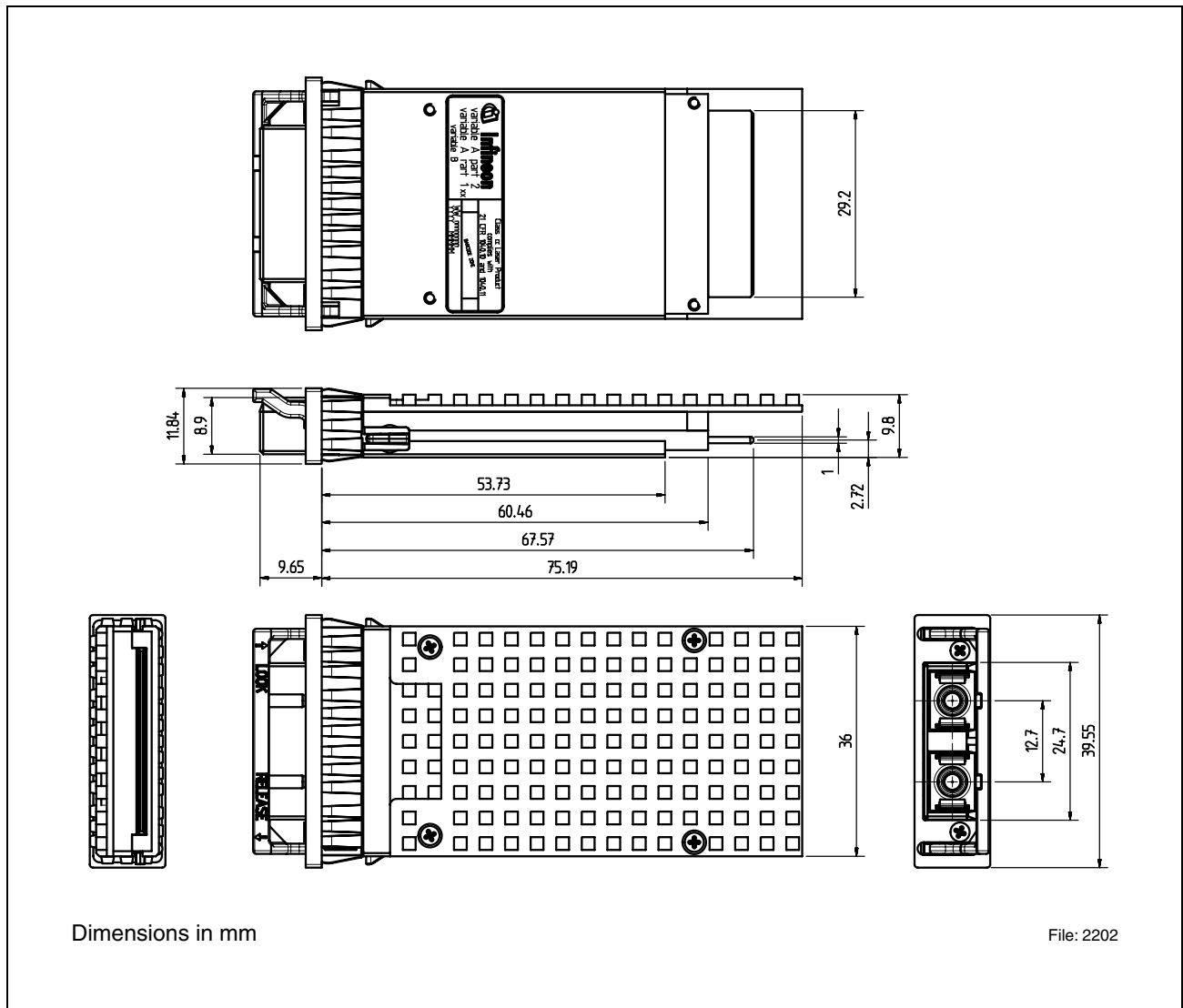

Figure 9 XPAK with Bail De-Latch Mechanism

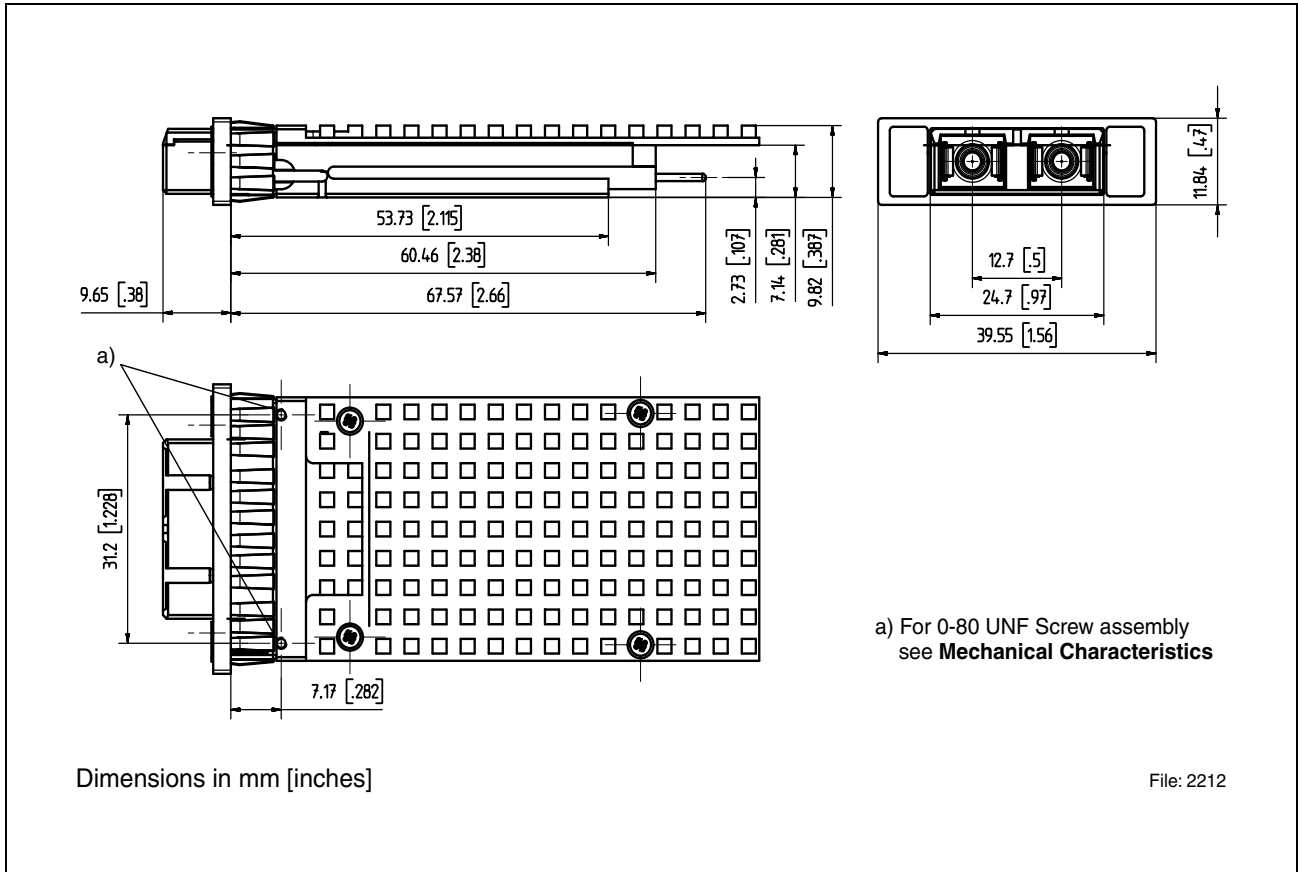

Figure 10 XPAK with No De-Latch Mechanism

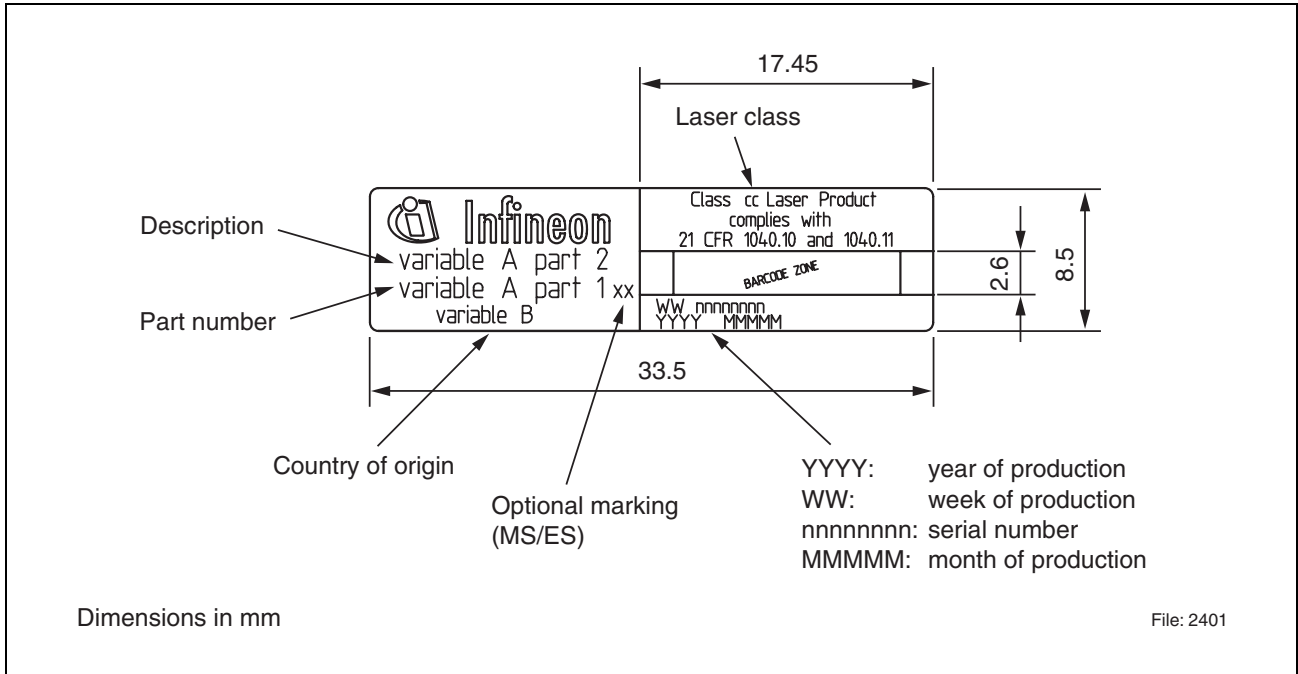

Figure 11 Label Description

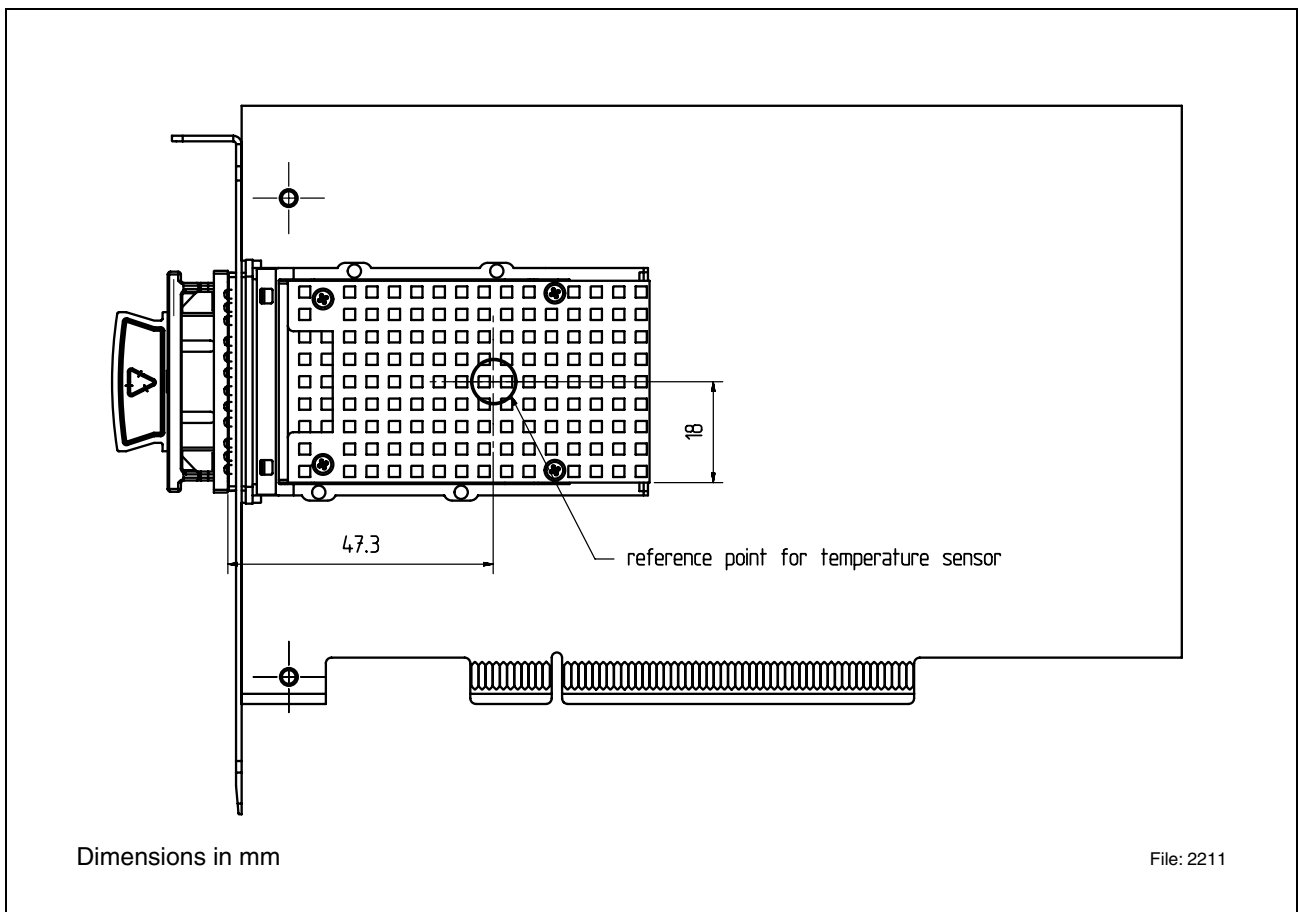

Figure 12 XPAK Temperature Reference Point

Revision History: 2004-05-13

DS2

Previous Version: 2004-02-24

Page	Subjects (major changes since last revision)
	V23833-G6104-A011 added
1	Optical Features changed
2	Electrical Features changed
9	Environment: Thermal Management Recommendations changed
9	Fibers and Connectors changed
9	Cage Requirement changed
14	Table " Electrical AC Characteristics Characteristics" changed
15	Table " Mechanical Characteristics " added
16	Table " Laser Data " added Figure 3 Required Labels added Figure 4 Laser Emission added
17	NVRAM Register Contents added
26	Figure 10 XPAK with No De-Latch Mechanism added
27	Figure 12 XPAK Temperature Reference Point changed

Edition 2004-05-13**Published by Infineon Technologies AG,
St.-Martin-Strasse 53,
81669 München, Germany****© Infineon Technologies AG 2004.
All Rights Reserved.****Attention please!**

The information herein is given to describe certain components and shall not be considered as a guarantee of characteristics.

Terms of delivery and rights to technical change reserved.

We hereby disclaim any and all warranties, including but not limited to warranties of non-infringement, regarding circuits, descriptions and charts stated herein.

Information

For further information on technology, delivery terms and conditions and prices please contact your nearest Infineon Technologies Office (www.infineon.com).

Warnings

Due to technical requirements components may contain dangerous substances. For information on the types in question please contact your nearest Infineon Technologies Office.

Infineon Technologies Components may only be used in life-support devices or systems with the express written approval of Infineon Technologies, if a failure of such components can reasonably be expected to cause the failure of that life-support device or system, or to affect the safety or effectiveness of that device or system. Life support devices or systems are intended to be implanted in the human body, or to support and/or maintain and sustain and/or protect human life. If they fail, it is reasonable to assume that the health of the user or other persons may be endangered.