

Preliminary Data Sheet

Overview

Features

- Step up converter (Boost Voltage)
- Boost Over- and Under-Voltage-Lockout
- Step down converter (Logic Voltage)
- 2% output voltage tolerance
- Logic Over- and Under-Voltage-Lockout
- Overtemperature Shutdown
- Power ON/OFF reset generator
- Digital window watchdog
- System Enable Output
- Ambient operation temperature range – 40 °C to 125 °C
- Wide Supply voltage operation range
- Very low current consumption
- Very small P-DSO-14-2 SMD package

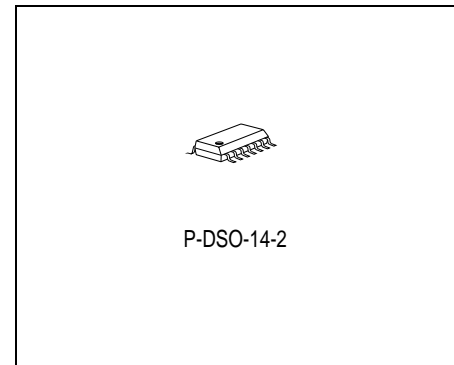

Type	Ordering Code	Package
TLE 6363 G	on request	P-DSO-14-2

Functional Description

General

The **TLE 6363 G** is a multifunctional power supply circuit especially designed for automotive applications.

It delivers a programmable step up voltage (Boost) and a precise 5 V fully short circuit protected output voltage (Buck).

The **TLE 6363 G** contains a power on reset feature to start up the system, an integrated digital window watchdog to monitor the connected microcontroller and a system enable output to indicate the microcontroller window watchdog faults.

The device is based on Infineon's power technology SPT® which allows bipolar and CMOS control circuitry to be integrated with DMOS power devices on the same monolithic circuitry.

The very small **P-DSO-14-2** SMD packages meet the application requirements.

Furthermore, the build-in features like under- and overvoltage lockout for boost- and buck-voltage and the overtemperature shutdown feature increase the reliability of the **TLE 6363 G** supply system.

Pin Definitions and Functions

Pin No. SO-14	Symbol	Function
1	R	Reference Input ; an external resistor from this pin to GND determines the reference current and the oscillator frequency
2	RO	Reset Output ; open drain output from reset comparator with an internal pull up resistor
3	WDI	Watchdog Input ; input for the watchdog control signal from the controller
4	GND	Ground ; analog signal ground
5	SEN	System Enable Output ; open drain output from Watchdog fail-circuit with an internal pull up resistor
6	BUC	Buck-Converter Compensation Input ; output of internal error amplifier; for loop-compensation connect an external R-C-series combination to GND
7	V_{CC}	Supply Voltage Output ; buck converter output; external blocking capacitor necessary
8	BUO	Buck Converter Output ; source of the integrated power-DMOS
9	V_{BOOST}	Boost Converter Input ; input supply voltage of the IC; coming from the boost converter output voltage; buck converter input voltage
10	BDS	Buck Driver Supply Input ; voltage to drive the buck converter powerstage
11	OVL	Boost Status Output ; open drain output from boost PWM comparator
12	BOFB	Boost Converter Feedback Input ; connect boost voltage divider to this pin; internal reference is the boost feedback threshold V_{BOFBTH}
13	BOGND	Boost-Ground ; power signal ground; source of boost converter power-DMOS
14	BOI	Boost Converter Input ; drain of the integrated buck converter power-DMOS

Pin Configuration

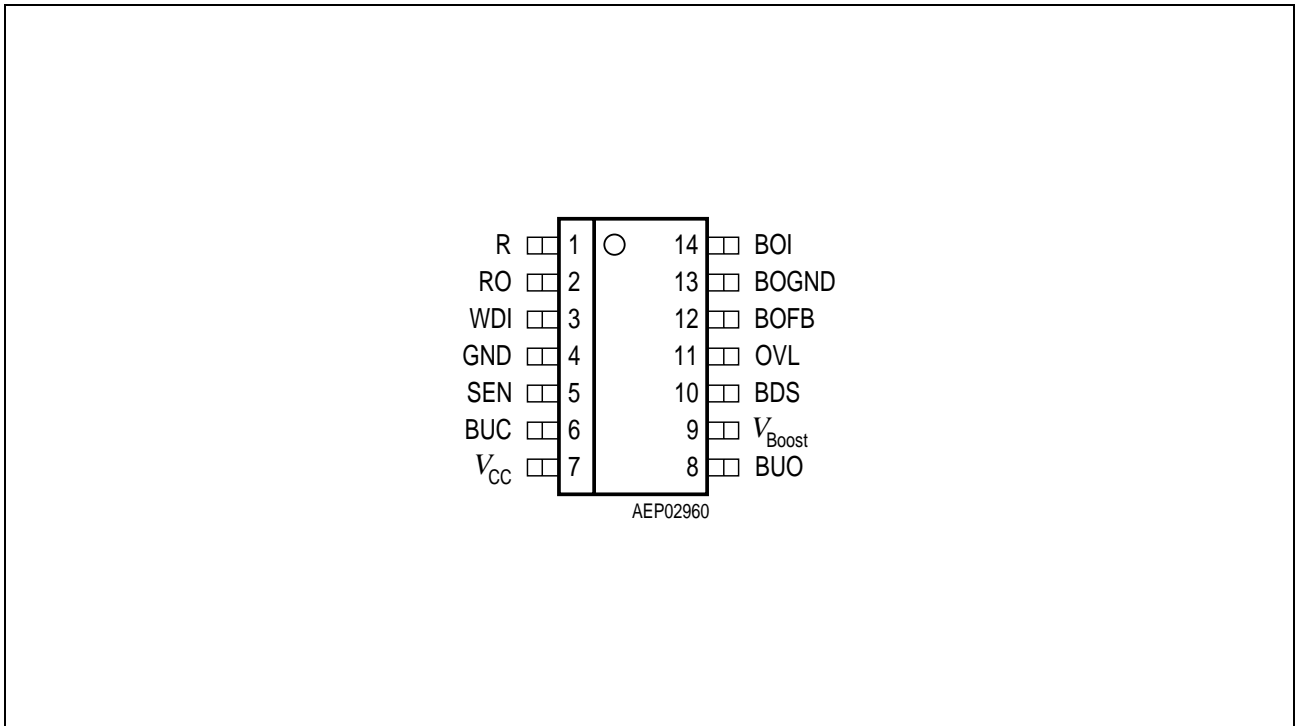

Figure 1 Pin Configuration (top view)

Block Diagram

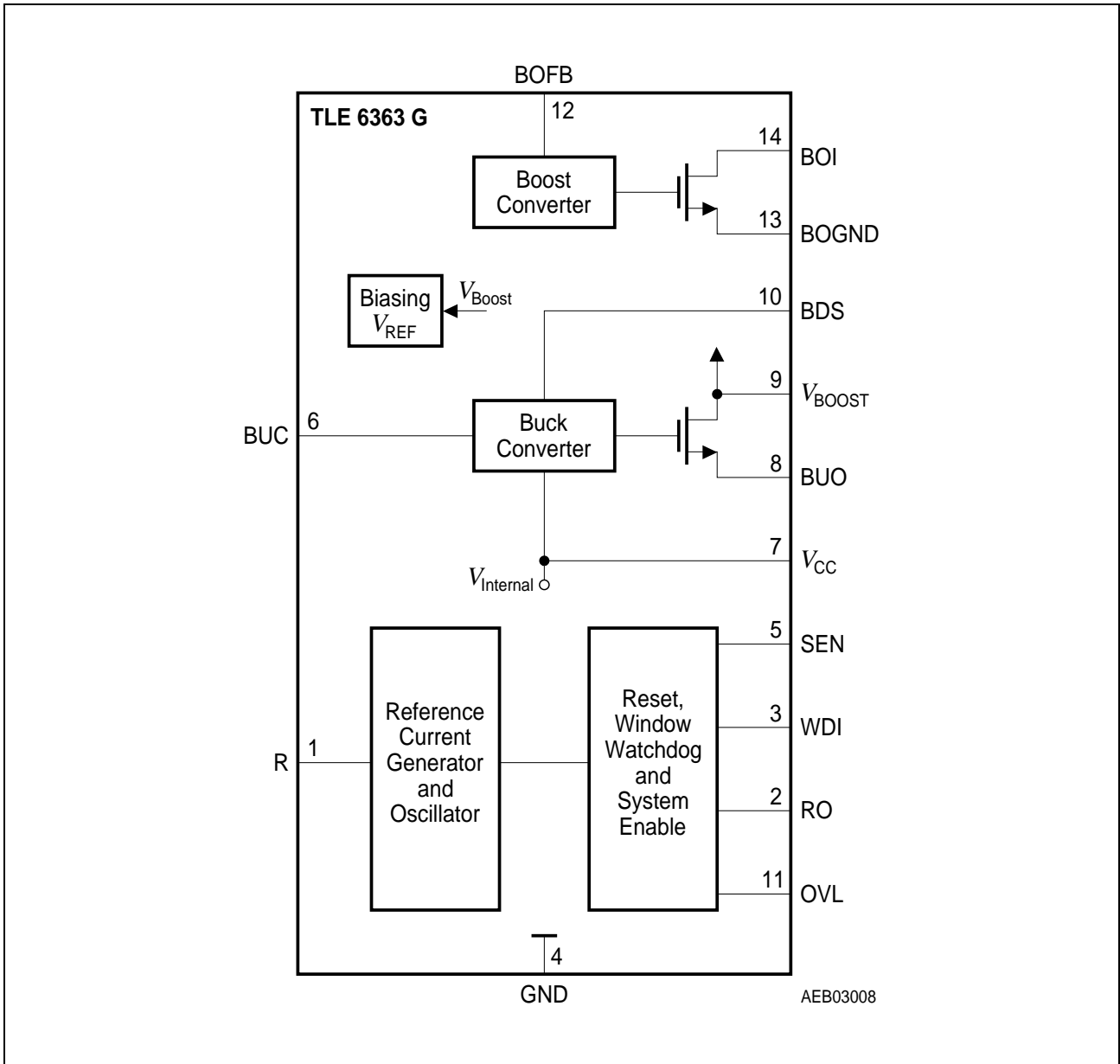

Figure 2 Block Diagram

Absolute Maximum Ratings

Parameter	Symbol	Limit Values		Unit	Remarks
		min.	max.		

Voltages

Boost input voltage	V_{BOI}	- 0.3	46	V	-
Boost output voltage	V_{BOOST}	- 0.3	46	V	-
Boost feedback voltage	V_{BOFB}	- 0.3	46	V	-
Buck output voltage	V_{BUO}	- 1	46	V	-
Buck driver supply voltage	V_{BDS}	- 0.3	48	V	-
Buck compensation input voltage	V_{BUC}	- 0.3	6.8	V	-
Logic supply voltage	V_{CC}	- 0.3	6.8	V	-
Reset output voltage	V_{RO}	- 0.3	6.8	V	-
System Enable output voltage	V_{SEN}	- 0.3	6.8	V	-
Current reference voltage	V_R	- 0.3	6.8	V	-
Watchdog input voltage	V_{WDI}	- 0.3	6.8	V	-
OVL output voltage	V_{OVL}	- 0.3	6.8	V	-

ESD-Protection (Human Body Model; $R = 1.5 \text{ k}\Omega$; $C = 100 \text{ pF}$)

All pins to GND	V_{HBM}	- 2	2	kV	-
-----------------	-----------	-----	---	----	---

Temperatures

Junction temperature	T_j	- 40	150	°C	-
Storage temperature	T_{stg}	- 50	150	°C	-

Note: Stresses above those listed here may cause permanent damage to the device. Exposure to absolute maximum rating conditions for extended periods may affect device reliability.

Operating Range

Parameter	Symbol	Limit Values		Unit	Remarks
		min.	max.		
Boost input voltage	V_{BOI}	- 0.3	40	V	-
Boost input voltage; (normal operation)	V_{BOOST}	5	35	V	V_{BOOST} increasing
Boost input voltage; (normal operation)	V_{BOOST}	4.5	36	V	V_{BOOST} decreasing
Boost input voltage	V_{BOOST}	- 0.3	4.5	V	Boost- and Buck-Converter OFF
Boost feedback voltage	V_{BOFB}	0	3.0	V	-
Buck output voltage	V_{BUO}	- 0.6	40	V	-
Buck driver supply voltage	V_{BDS}	- 0.3	48	V	-
Buck compensation input voltage	V_{BUC}	0	3.0	V	-
Logic supply voltage	V_{CC}	4.00	6.25	V	-
Reset output voltage	V_{RO}	- 0.3	$V_{CC} + 0.3$	V	-
System Enable output voltage	V_{SEN}	- 0.3	$V_{CC} + 0.3$	V	-
Watchdog input voltage	V_{WDI}	0	$V_{CC} + 0.3$	V	-
Current reference voltage	V_R	0	3.0	V	-
Junction temperature	T_j	- 40	150	°C	-

Thermal Resistance

Junction ambient	R_{thj-a}	-	120	K/W	-
------------------	-------------	---	-----	-----	---

Note: In the operating range, the functions given in the circuit description are fulfilled.

Electrical Characteristics

$8\text{ V} < V_{\text{Boost}} < 35\text{ V}$; $4.75\text{ V} < V_{\text{CC}} < 5.25\text{ V}$; $-40\text{ }^{\circ}\text{C} < T_j < 150\text{ }^{\circ}\text{C}$; $R_R = 47\text{ k}\Omega$; all voltages with respect to ground; positive current defined flowing into pin; unless otherwise specified.

Parameter	Symbol	Limit Values			Unit	Test Conditions
		min.	typ.	max.		

Current Consumption

Current consumption; see application circuit	I_{Boost}	–	1.5	4	mA	$I_{\text{CC}} = 0\text{ mA}$; $I_{\text{BoLoad}} = 0\text{ mA}$
Current consumption; see application circuit	I_{Boost}	–	5	10	mA	$I_{\text{CC}} = 200\text{ mA}$; $I_{\text{BoLoad}} = 50\text{ mA}$

Under- and Over-Voltage Lockout at V_{Boost}

UV ON voltage; boost and buck conv. ON	V_{BOUVON}	4.0	4.5	5.0	V	V_{BOOST} increasing;
UV OFF voltage; boost and buck conv. OFF	V_{BOUVOFF}	3.5	4.0	4.5	V	V_{BOOST} decreasing
UV Hysteresis voltage	V_{BOUVHY}	0.2	0.5	1.0	V	HY = ON - OFF
OV OFF voltage; boost conv. OFF	V_{BOOVFF}	34	37	40	V	V_{BOOST} increasing
OV ON voltage; boost conv. ON	V_{BOOVON}	30	33	36	V	V_{BOOST} decreasing
OV Hysteresis voltage	V_{BOUVHY}	1.5	4	10	V	HY = OFF - ON

Over-Voltage Lockout at V_{CC}

OV OFF voltage; buck conv. OFF	V_{BUOVFF}	5.5	6.0	6.5	V	V_{CC} increasing
OV ON voltage; buck conv. ON	V_{BUOVON}	5.25	5.75	6.25	V	V_{CC} decreasing
OV Hysteresis voltage	V_{BUOVHY}	0.10	0.25	0.50	V	HY = OFF - ON

Electrical Characteristics (cont'd)

$8\text{ V} < V_{\text{Boost}} < 35\text{ V}$; $4.75\text{ V} < V_{\text{CC}} < 5.25\text{ V}$; $-40\text{ }^{\circ}\text{C} < T_j < 150\text{ }^{\circ}\text{C}$; $R_R = 47\text{ k}\Omega$; all voltages with respect to ground; positive current defined flowing into pin; unless otherwise specified.

Parameter	Symbol	Limit Values			Unit	Test Conditions
		min.	typ.	max.		

Boost-Converter; BOI, BOFB and V_{BOOST}

Boost voltage; see application circuit	V_{BOOST}	24.0	27.5	31.0	V	$5\text{ mA} < I_{\text{Boost}} < 100\text{ mA}$; $T_j = 25\text{ }^{\circ}\text{C}$ $8\text{ V} < V_{\text{Batt}} < 16\text{ V}$
Boost Voltage; see application circuit	V_{BOOST}	23	–	32	V	$5\text{ mA} < I_{\text{Boost}} < 100\text{ mA}$; $8\text{ V} < V_{\text{Batt}} < 16\text{ V}$
Efficiency; see. appl. circuit	η	–	80	–	%	$I_{\text{Boost}} = 100\text{ mA}$
Power-Stage ON resistance	R_{BOON}	–	0.6	0.75	Ω	$T_j = 25\text{ }^{\circ}\text{C}$; $I_{\text{BOI}} = 1\text{ A}$
Power-Stage ON resistance	R_{BOON}	–	–	1.4	Ω	$I_{\text{BOI}} = 1\text{ A}$
Boost overcurrent threshold	I_{BOOC}	1.0	1.3	1.8	A	–
Feedback threshold voltage	V_{BOFBTH}	2.55	2.7	2.85	V	$V_{\text{BOI}} = 12\text{ V}$ $I_{\text{Boost}} = 25\text{ mA}$
Feedback input current	I_{FB}	– 2	– 0.4	0	μA	$2\text{ V} < V_{\text{BOFB}} < 4\text{ V}$

Buck-Converter; BUO, BDS, BUC and V_{CC}

Logic supply voltage	V_{CC}	4.9	–	5.1	V	$1\text{ mA} < I_{\text{CC}} < 250\text{ mA}$; see. appl. circuit
Efficiency; see. appl. circuit	η	–	85	–	%	$I_{\text{CC}} = 250\text{ mA}$; $V_{\text{Boost}} = 25\text{ V}$
Power-Stage ON resistance	R_{BUON}	–	0.38	0.5	Ω	$T_j = 25\text{ }^{\circ}\text{C}$; $I_{\text{BUO}} = 1\text{ A}$
Power-Stage ON resistance	R_{BUON}	–	–	1.0	Ω	$I_{\text{BUO}} = 1\text{ A}$
Buck overcurrent threshold	I_{BUOC}	0.7	0.95	1.2	A	–
Input current on pin V_{CC}	I_{CC}	–	0.2	0.5	mA	$V_{\text{CC}} = 5\text{ V}$

Electrical Characteristics (cont'd)

8 V < V_{Boost} < 35 V; 4.75 V < V_{CC} < 5.25 V; $-40\text{ }^{\circ}\text{C} < T_j < 150\text{ }^{\circ}\text{C}$; $R_R = 47\text{ k}\Omega$; all voltages with respect to ground; positive current defined flowing into pin; unless otherwise specified.

Parameter	Symbol	Limit Values			Unit	Test Conditions
		min.	typ.	max.		
Buck Gate supply voltage; $V_{\text{BGS}} = V_{\text{BDS}} - V_{\text{BOOST}}$	V_{BGS}	5	–	10	V	–

**Reference Input; R
(Oscillator; Timebase for Boost- and Buck-Converter, Reset and Watchdog)**

Voltage on pin R	V_R	1.3	1.4	1.5	V	–
Oscillator frequency	f_{OSC}	85	95	105	kHz	$T_j = 25\text{ }^{\circ}\text{C}$
Oscillator frequency	f_{OSC}	75	–	115	kHz	–
Cycle time for watchdog and reset timing	t_{CYL}	–	1.05	–	ms	$t_{\text{CYL}} = 100/f_{\text{OSC}}$

Reset Generator; RO

Reset threshold; V_{CC} decreasing/increasing	V_{RT}	4.50	4.65	4.75	V	V_{RO} H to L or L to H transition; V_{RO} remains low down to $V_{\text{CC}} > 1\text{ V}$
Reset low voltage	V_{ROL}	–	0.2	0.4	V	$I_{\text{ROL}} = 2\text{ mA}$; $2.5\text{ V} < V_{\text{CC}} < V_{\text{RT}}$
Reset low voltage	V_{ROL}	–	0.2	0.4	V	$I_{\text{ROL}} = 0.2\text{ mA}$; $1\text{ V} < V_{\text{CC}} < V_{\text{RT}}$
Reset high voltage	V_{ROH}	$V_{\text{CC}} - 0.1$	–	$V_{\text{CC}} + 0.1$	V	$I_{\text{ROH}} = 0\text{ mA}$
Reset pull up current	I_{RO}	–	240	–	μA	$0\text{ V} < V_{\text{RO}} < 4\text{ V}$
Reset Reaction time	t_{RR}	50	100	150	μs	$V_{\text{CC}} < V_{\text{RT}}$
Power-up reset delay time	t_{RD}	–	64	–	t_{CYL}	$V_{\text{CC}} \geq 4.8\text{ V}$

Electrical Characteristics (cont'd)

8 V < V_{Boost} < 35 V; 4.75 V < V_{CC} < 5.25 V; $-40\text{ }^{\circ}\text{C} < T_j < 150\text{ }^{\circ}\text{C}$; $R_R = 47\text{ k}\Omega$; all voltages with respect to ground; positive current defined flowing into pin; unless otherwise specified.

Parameter	Symbol	Limit Values			Unit	Test Conditions
		min.	typ.	max.		

Watchdog Generator; WDI

H-input voltage threshold	V_{WDIH}	–	–	$0.7 \times V_{CC}$	V	–
L-input voltage threshold	V_{WDIL}	$0.3 \times V_{CC}$	–	–	V	–
Watchdog period	T_{WD}	–	128	–	t_{CYL}	$V_{CC} \geq 4.8\text{ V}$
Start of reset; after watchdog time-out	t_{SR}	–	64	–	t_{CYL}	$V_{CC} \geq 4.8\text{ V}$
Reset duration; after watchdog time-out	t_{WDR}	–	64	–	t_{CYL}	$V_{CC} \geq 4.8\text{ V}$
Open window time	t_{OW}	–	32	–	t_{CYL}	$V_{CC} \geq 4.8\text{ V}$
Closed window time	t_{CW}	–	32	–	t_{CYL}	$V_{CC} \geq 4.8\text{ V}$
Window watchdog trigger time	t_{WD}	–	46.4	–	t_{CYL}	$V_{CC} \geq 4.8\text{ V}$

System Enable Output; SEN

Enable low voltage	V_{SENL}	–	0.2	0.4	V	$I_{SENL} = 2\text{ mA}$; $2.5\text{ V} < V_{CC} < V_{RT}$
Enable low voltage	V_{SENL}	–	0.2	0.4	V	$I_{SENL} = 0.2\text{ mA}$; $1\text{ V} < V_{CC} < V_{RT}$
Enable high voltage	V_{SENH}	$V_{CC} - 0.1$	–	$V_{CC} + 0.1$	V	$I_{SENH} = 0\text{ mA}$
Enable pull up current	I_{SEN}	–	240	–	μA	$0\text{ V} < V_{SEN} < 4\text{ V}$

Electrical Characteristics (cont'd)

$8\text{ V} < V_{\text{Boost}} < 35\text{ V}$; $4.75\text{ V} < V_{\text{CC}} < 5.25\text{ V}$; $-40\text{ }^\circ\text{C} < T_j < 150\text{ }^\circ\text{C}$; $R_R = 47\text{ k}\Omega$; all voltages with respect to ground; positive current defined flowing into pin; unless otherwise specified.

Parameter	Symbol	Limit Values			Unit	Test Conditions
		min.	typ.	max.		

Boost Status Output; OVL

Enable low voltage	V_{OVLL}	–	0.2	0.4	V	$I_{\text{OVLL}} = 1\text{ mA}$; $2.5\text{ V} < V_{\text{CC}} < V_{\text{RT}}$
Boost feedback threshold voltage;	V_{OVLTH}	2.3	2.45	2.6	V	See application circuit

Thermal Shutdown (Boost and Buck-Converter OFF)

Thermal shutdown junction temperature	T_{jSD}	150	175	200	$^\circ\text{C}$	–
Thermal switch-on junction temperature	T_{jSO}	120	–	170	$^\circ\text{C}$	–
Temperature hysteresis	ΔT	–	30	–	K	–

Note: The listed characteristics are ensured over the operating range of the integrated circuit. Typical characteristics specify mean values expected over the production spread. If not otherwise specified, typical characteristics apply at $T_A = 25\text{ }^\circ\text{C}$ and the given supply voltage.

Circuit Description

Below some important sections of the TLE 6363 are described in more detail.

Power On Reset

In order to avoid any system failure, a sequence of several conditions has to be passed. In case of V_{CC} power down ($V_{CC} < V_{RT}$ for $t > t_{RR}$) a logic LOW signal is generated at the pin RO to reset an external microcontroller. When the level of V_{CC} reaches the reset threshold V_{RT} , the signal at RO remains LOW for the Power-up reset delay time t_{RD} before switching to HIGH. If V_{CC} drops below the reset threshold V_{RT} for a time extending the reset reaction time t_{RR} , the reset circuit is activated and a power down sequence of period t_{RD} is initiated. The reset reaction time t_{RR} avoids wrong triggering caused by short “glitches” on the V_{CC} -line.

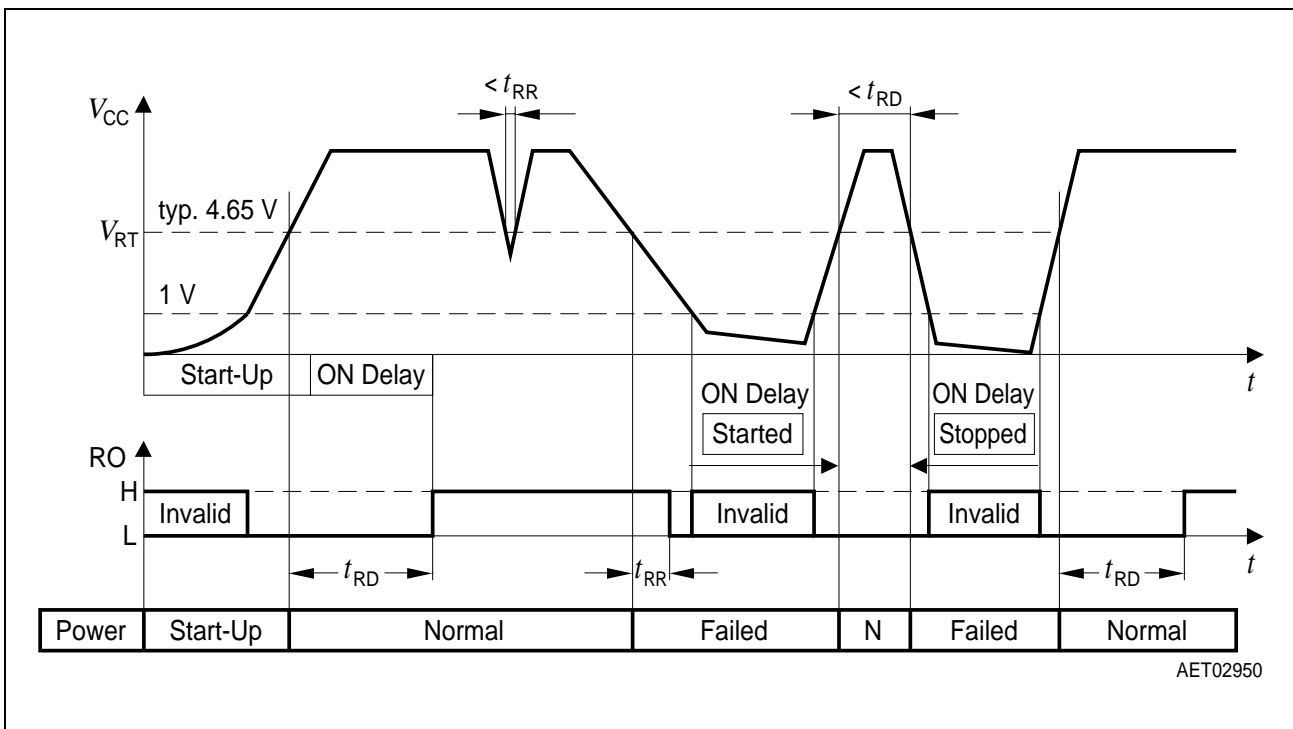

Figure 3 Reset Function

Watchdog Operation

The watchdog uses one hundred of the oscillator's clock signal period as a timebase, defined as the watchdog cycle time t_{CYL} .

After power-on, the reset output signal at the RO pin (microcontroller reset) is kept LOW for the reset delay time t_{RD} , i.e. 64 cycles. With the LOW to HIGH transition of the signal at RO the device starts the closed window time $t_{CW} = 32$ cycles. A trigger signal within this window is interpreted as a pretrigger failure according to the figures shown below. After the closed window the open window with the duration t_{OW} is started. The open window lasts at minimum until the trigger process has occurred, at maximum t_{OW} is 32 cycles.

A HIGH to LOW transition of the watchdog trigger signal on pin WDI is taken by a trigger. To avoid wrong triggering due to parasitic glitches two HIGH samples followed by two LOW samples (sample period t_{CYL}) are decoded as a valid trigger. If a trigger signal appears at the watchdog input pin WDI during the open window or a power up/down occurs, the watchdog window signal is reset and a new closed window follows.

A reset is generated (RO goes LOW) if there is no trigger pulse during the open window or if a pretrigger occurs during the closed window. This reset happens after 64 cycles after the latest valid closed window start time and lasts for further 64 cycles.

The triggering is correct also, if the first three samples (two HIGH one LOW) of the trigger pulse at pin WDI are inside the closed window and only the fourth sample (the second LOW sample) is taken in the open window.

In addition to the microcontroller reset signal RO the device generates a system enable signal at pin SEN. If RO is HIGH the system enable goes active HIGH with the first valid watchdog trigger pulse at pin WDI. The SEN output goes LOW immediately if a pretrigger, a missing trigger or a power down reset occurs.

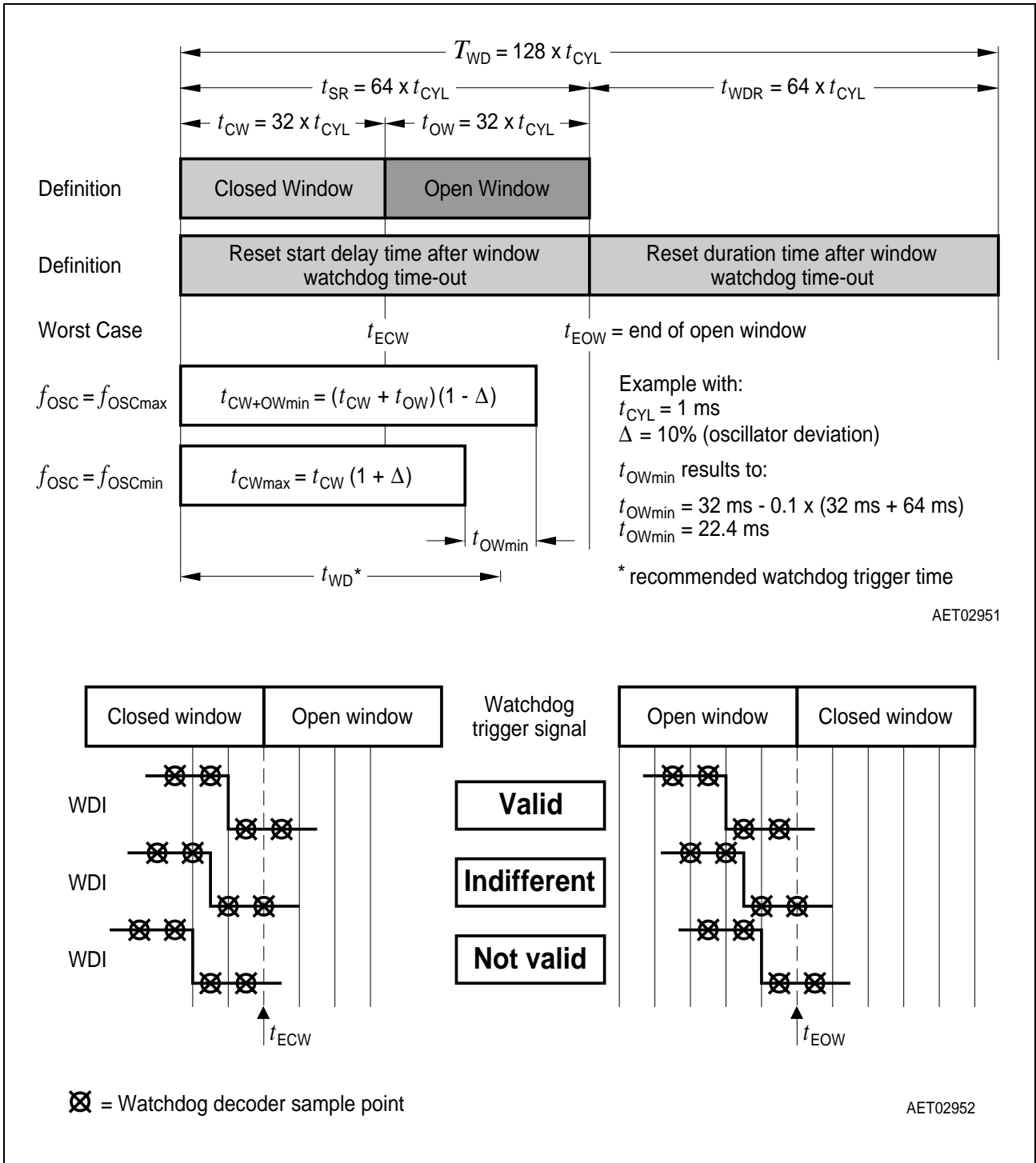

Figure 4 Window Watchdog Definitions

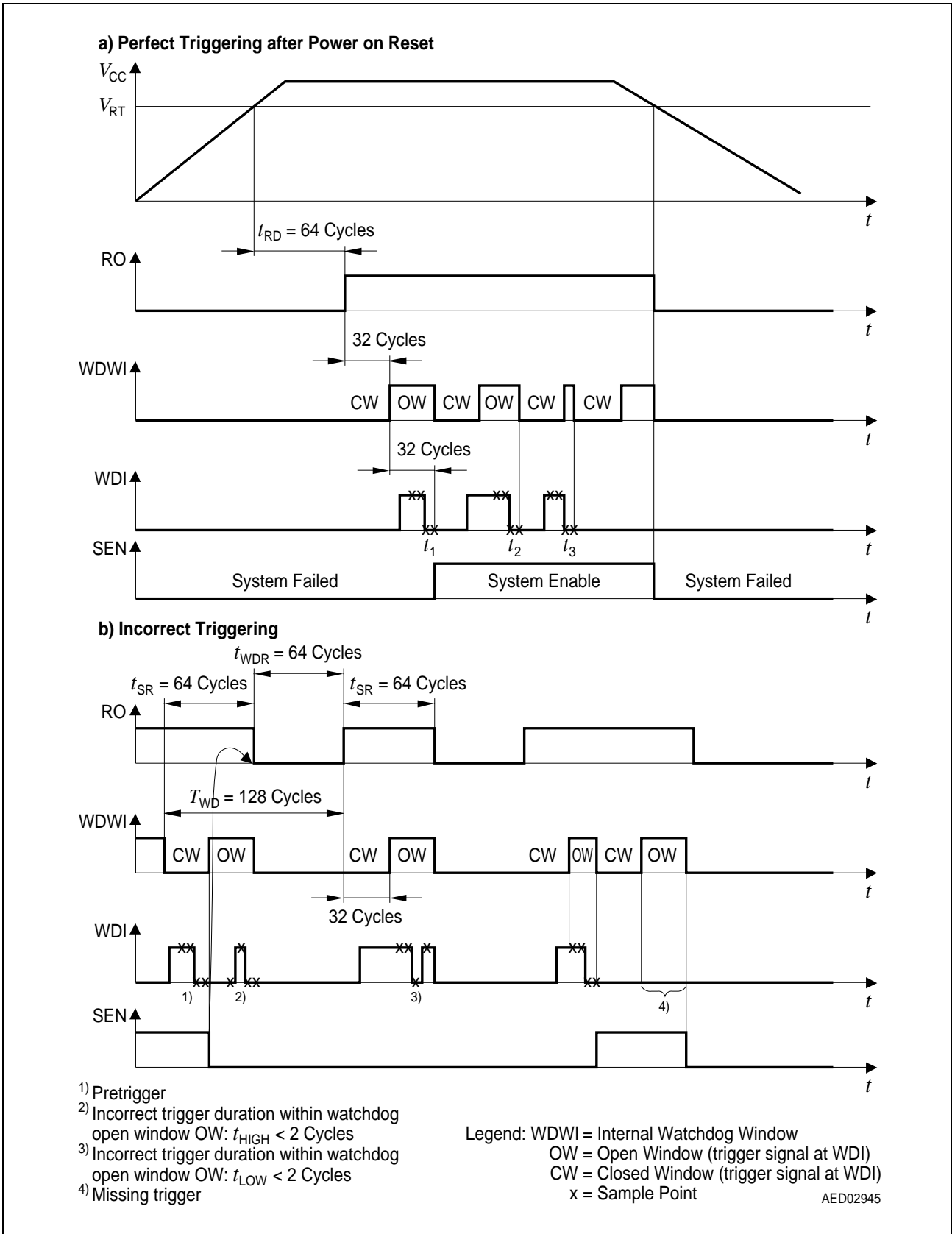

Figure 5 Window Watchdog Function

Boost Converter

The TLE 6363 contains a fully integrated boost converter (except the boost-diode), which provides a supply voltage for an energy reserve e.g. an airbag firing system. The regulated boost output voltage V_{BOOST} is programmable by a divider network (external resistors) providing the feedback voltage for the boost feedback pin BOFB. The energy which is stored in the external electrolytic capacitor at V_{BOOST} guarantees accurate airbag firing, even if the battery is disconnected by a car crash.

The boost inductance L_{BO} (typ. 100 μH) is PWM-switched by an integrated current limited power DMOS transistor with a programmable (external resistor R_{R}) frequency. An internal bandgap reference provides a temperature independent, on chip trimmed reference voltage for the regulation loop. An error amplifier compares the reference voltage with the boost feedback signal V_{BOFB} from the external divider network (determination of the output boost voltage V_{BOOST}).

Application note for programming the output voltage at pin V_{BOOST} :

$$V_{\text{BOOST}} = V_{\text{BOFBTH}} \times \frac{(R_{\text{BO1}} + R_{\text{BO2}})}{R_{\text{BO2}}}$$

With a PWM (Pulse Width Modulation) comparator the output of the error amplifier is compared to a periodic linear ramp, provided by a sawtooth signal of the oscillator connected to pin R. A logic signal with variable pulse width is generated. It passes through the logic circuits (sets the output latch PWM-FF) and driver circuits to the power switching DMOS. The Schmitt-trigger output resets the output flip-flop PWM-FF by NOR 2. The PWM signal is gated by the NAND 2 to guarantee a dominant reset.

Application Note:

A short circuit from V_{BOOST} to ground will not destroy the IC, however, it may damage the external boost diode or the boost inductance if there is no overcurrent limitation in that path.

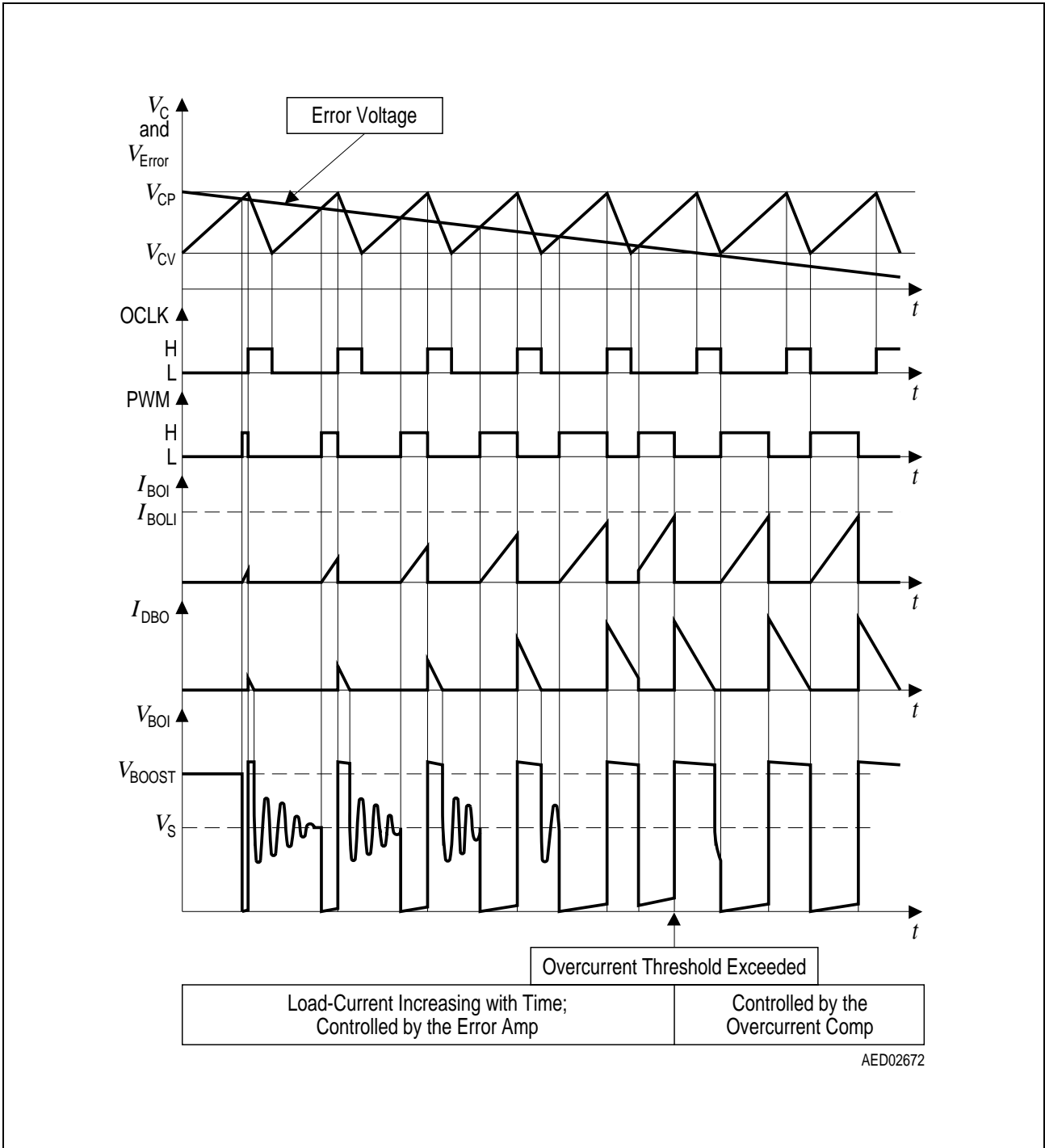

Figure 7 Most Important Waveforms of the Boost Converter Circuit

Buck Converter

A stabilized logic supply voltage (typ. 5 V) for general purpose is realized in the system by a buck converter. An external buck-inductance L_{BU} is PWM switched by a high side DMOS power transistor with the programmed frequency (pin R).

The buck regulator supply is given by the boost converter output V_{BOOST} , in case of a battery power-down the stored energy of the boost converter capacitor is used.

Like the boost converter, the buck converter uses the temperature compensated bandgap reference voltage (typ. 2.8 V) for its regulation loop.

This reference voltage is connected to the non-inverting input of the error amplifier and an internal voltage divider supplies the inverting input. Therefore the output voltage V_{CC} is fixed due to the internal resistor ratio to typ. 5.0 V.

The output of the error amplifier goes to the inverting input of the PWM comparator as well as to the buck compensation output BUC.

When the error amplifier output voltage exceeds the sawtooth voltage the output power MOS-transistor is switched on. So the duration of the output transistor conduction phase depends on the V_{CC} level. A logic signal PWM with variable pulse width is generated.

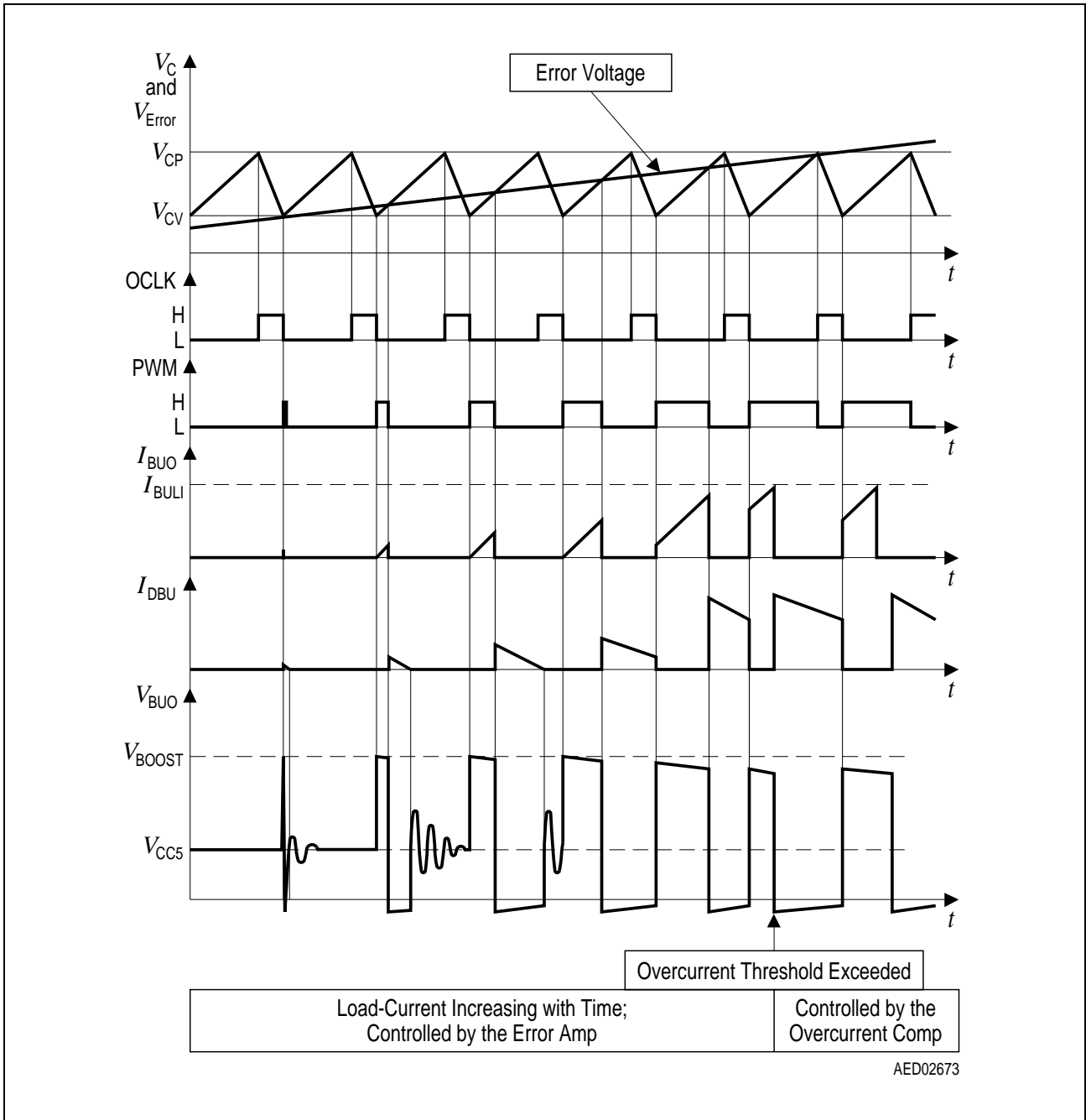

Figure 9 Most Important Waveforms of the Buck Converter Circuit

Application Circuit

Figure 10 shows the application circuit of the TLE 6363 with the suggested external parts.

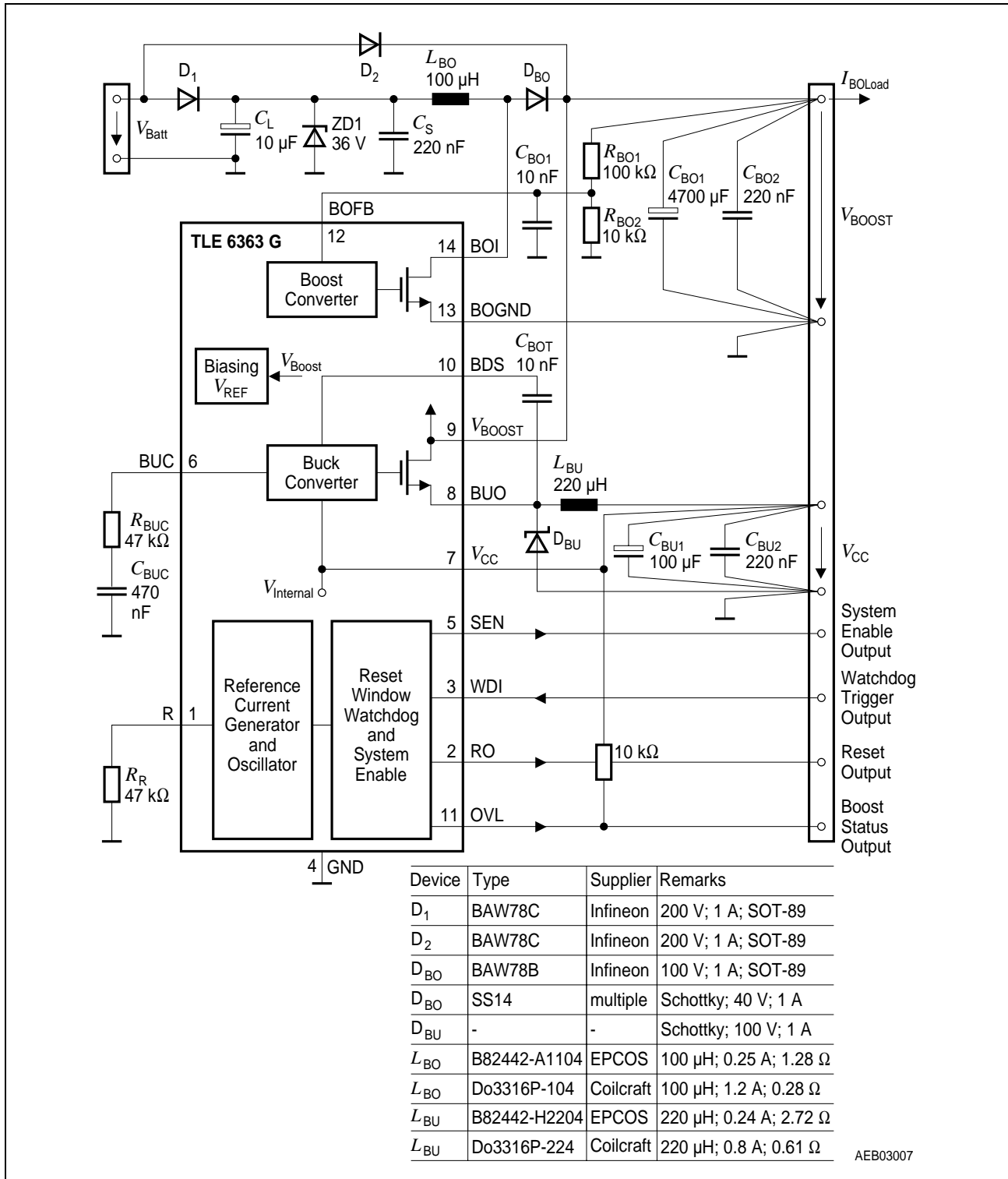
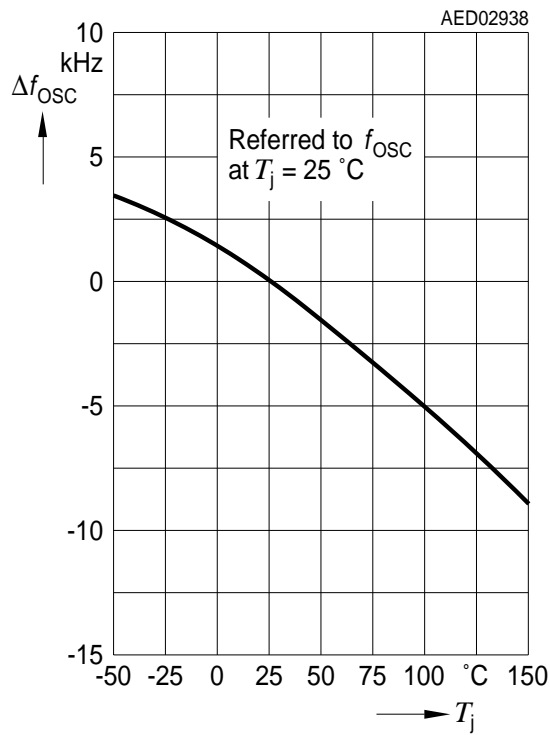

Figure 10 Application Circuit

Diagrams: Oscillator and Boost/Buck-Converter Performance

In the following the behaviour of the Boost/Buck-converter and the oscillator is shown.

Oscillator Frequency Deviation vs. Junction Temperature



Boost Feedback Current vs. Junction Temperature

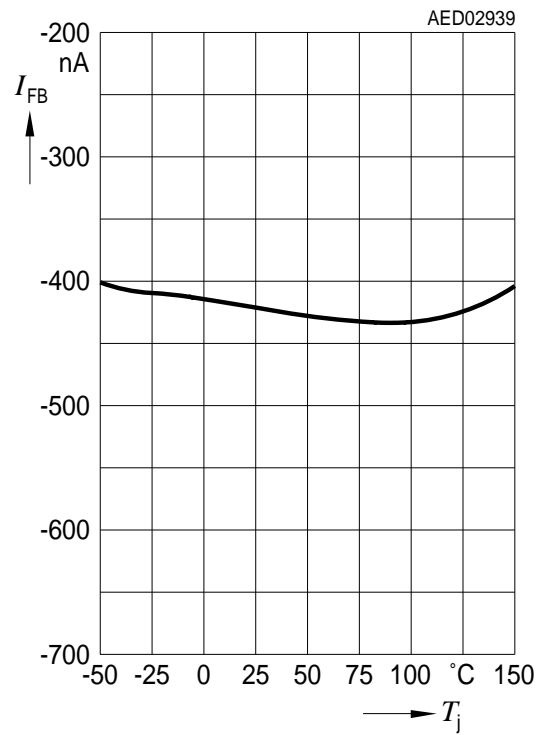

Current Consumption vs. Junction Temperature

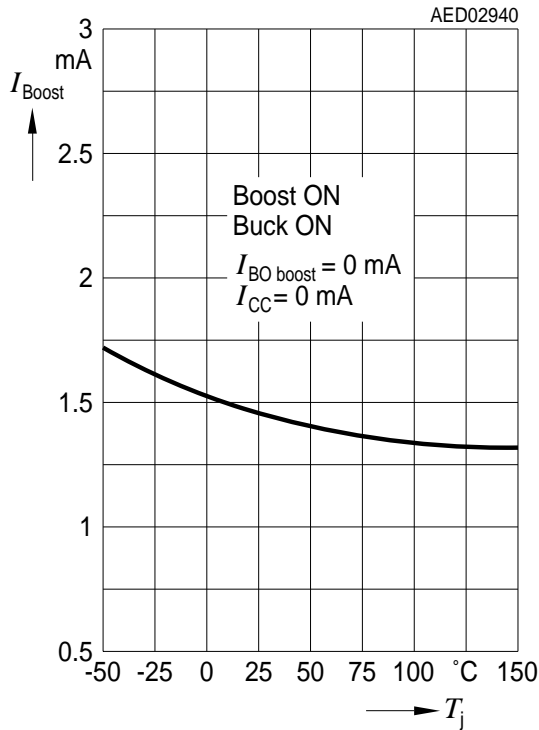

Efficiency Buck vs. Boost Voltage

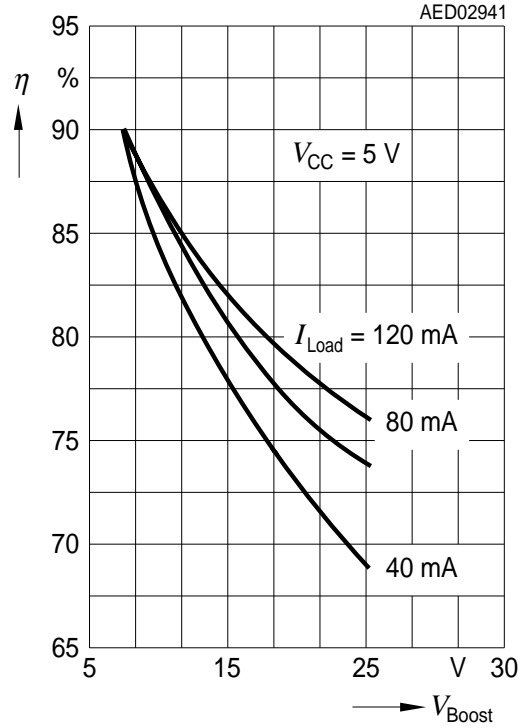

Efficiency Buck vs. Load

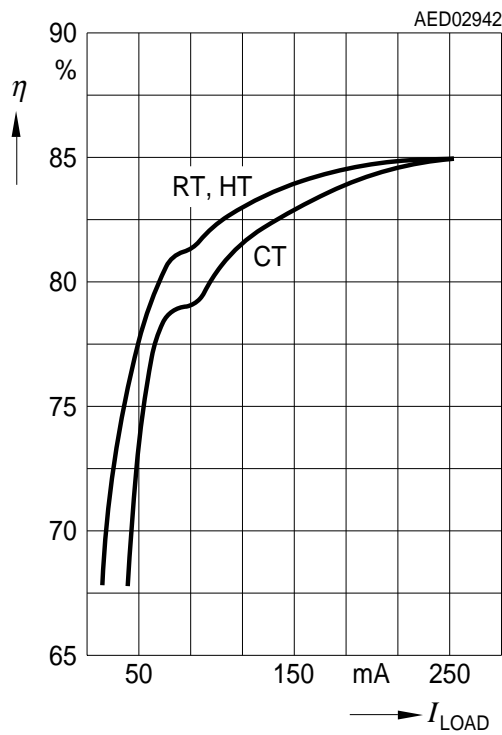

Efficiency Boost vs. Input Voltage

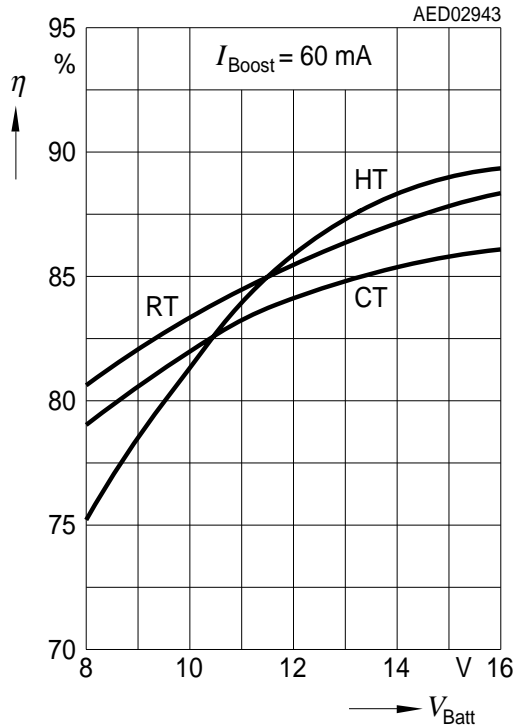

Boost Output Voltage vs. Load

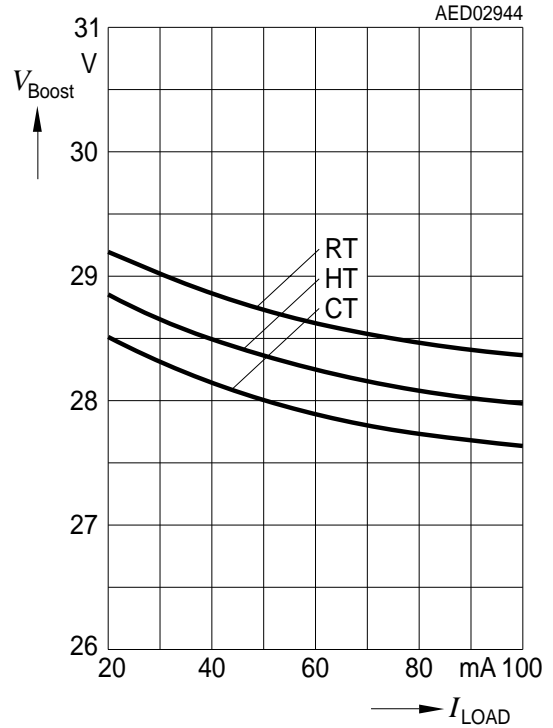

Oscillator Frequency vs. Resistor from R to GND

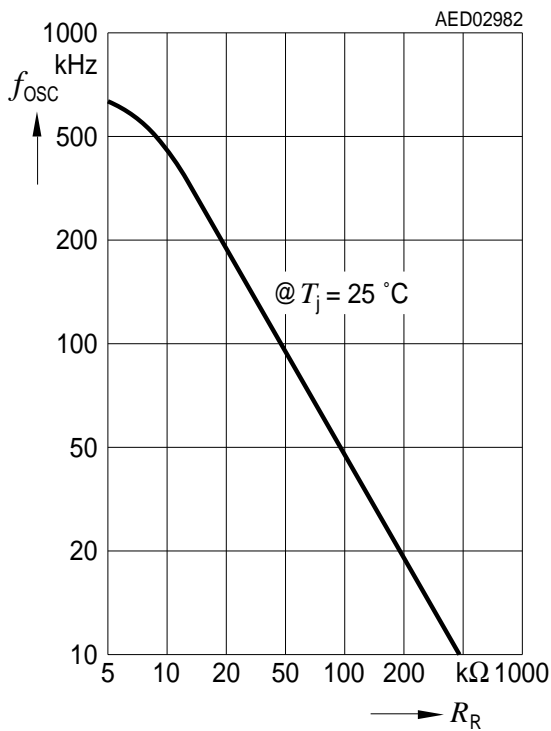

Boost and Logic Output Voltage vs. Junction Temperature

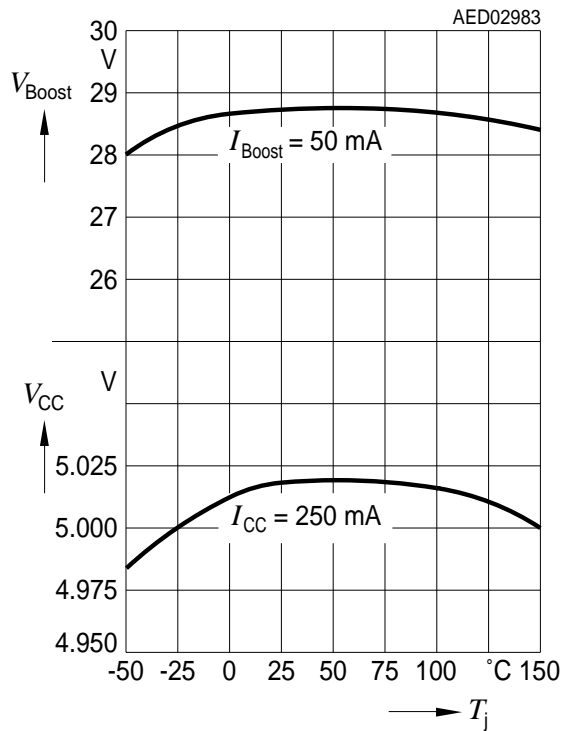

Boost and Buck ON Resistance vs. Junction Temperature

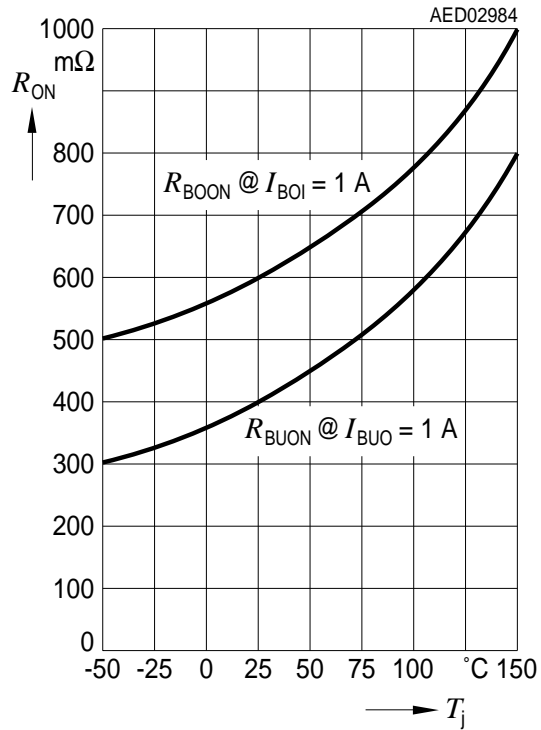

Boost and Buck Overcurrent Threshold vs. Junction Temperature

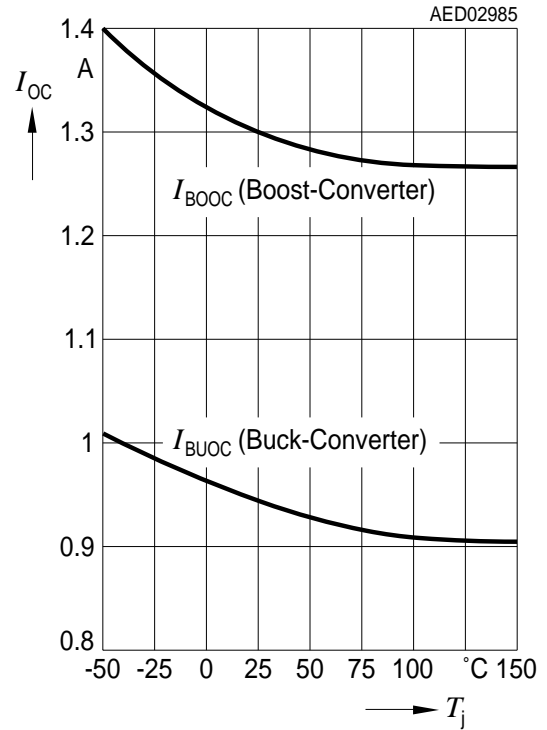

Package Outlines

P-DSO-14-2
(Plastic Dual Small Outline Package)

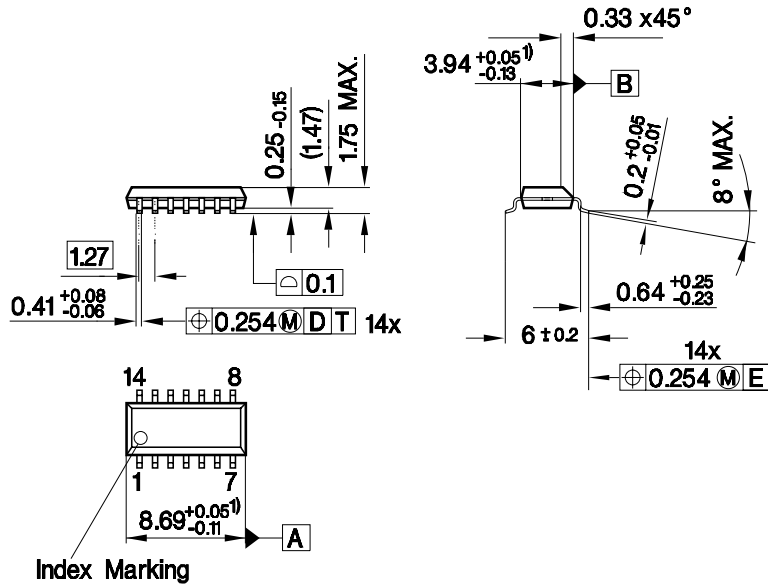

1) Does not include plastic or metal protrusion of 0.15 max. per side

GPS05474

Sorts of Packing

Package outlines for tubes, trays etc. are contained in our Data Book "Package Information"

SMD = Surface Mounted Device

Dimensions in mm

Edition 2000-11-8

**Published by Infineon Technologies AG,
St.-Martin-Strasse 53,
D-81541 München, Germany**

**© Infineon Technologies AG 2000.
All Rights Reserved.**

Attention please!

The information herein is given to describe certain components and shall not be considered as warranted characteristics.

Terms of delivery and rights to technical change reserved.

We hereby disclaim any and all warranties, including but not limited to warranties of non-infringement, regarding circuits, descriptions and charts stated herein.

Infineon Technologies is an approved CECC manufacturer.

Information

For further information on technology, delivery terms and conditions and prices please contact your nearest Infineon Technologies Office in Germany or our Infineon Technologies Representatives worldwide (see address list).

Warnings

Due to technical requirements components may contain dangerous substances. For information on the types in question please contact your nearest Infineon Technologies Office.

Infineon Technologies Components may only be used in life-support devices or systems with the express written approval of Infineon Technologies, if a failure of such components can reasonably be expected to cause the failure of that life-support device or system, or to affect the safety or effectiveness of that device or system. Life support devices or systems are intended to be implanted in the human body, or to support and/or maintain and sustain and/or protect human life. If they fail, it is reasonable to assume that the health of the user or other persons may be endangered.