

**Medium Power  
1300 nm FP Laser**

**STM51004x  
STM51005x**

**Features**

- Designed for applications in fiber optic networks
- Laser Diode with Multi-Quantum Well structure
- Suitable for bit rates up to 1 Gbit/s
- Ternary Photodiode at rear mirror for monitoring and control of radiant power
- Hermetically sealed subcomponents, similar to TO 46
- SM pigtail with optional connector



Pin Configuration and Flange

Pin Configuration and Flange

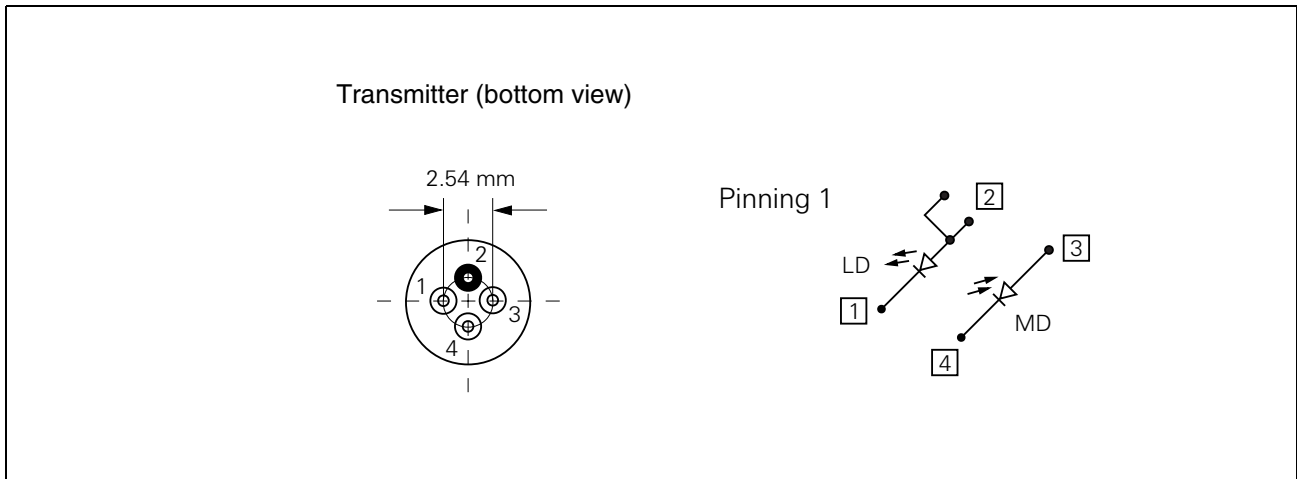

Figure 1 Transmitter

Available Pinnings with and without Flange

Type	Transmitter	Flange
STM51004x	1	without
STM51005x	1	with

## Description

### Differences between a Fabry-Perot and a DFB Laserdiode

A conventional laser consists of an amplifying medium and two end mirrors. The cavity is longer than one wavelength, and a standing wave is created. The number  $n$  of half wavelengths  $\lambda$  is  $n = 2 \times \frac{L}{\lambda}$ . If  $L \gg \lambda$  then we speak of a Fabry-Perot Laser because the laserdiode emits multi-longitudinal modes. Typically the laserdiode is 250  $\mu\text{m}$  long. For  $\lambda = 1310 \text{ nm}/1550 \text{ nm}$   $n$  is about 350. Therefore for many neighboring wavelengths the “standing wavelength” condition specified above is fulfilled. For a DFB-Laser a special grating acts as a distributed filter allowing only one of the cavity’s longitudinal modes to propagate. This can be described with a reduced oscillator length  $\tilde{L}$  which is in the range of  $\lambda$ . For such a reduced oscillator length the standing wavelength condition will be fulfilled for  $n \approx 2$  what means for only one wavelength.

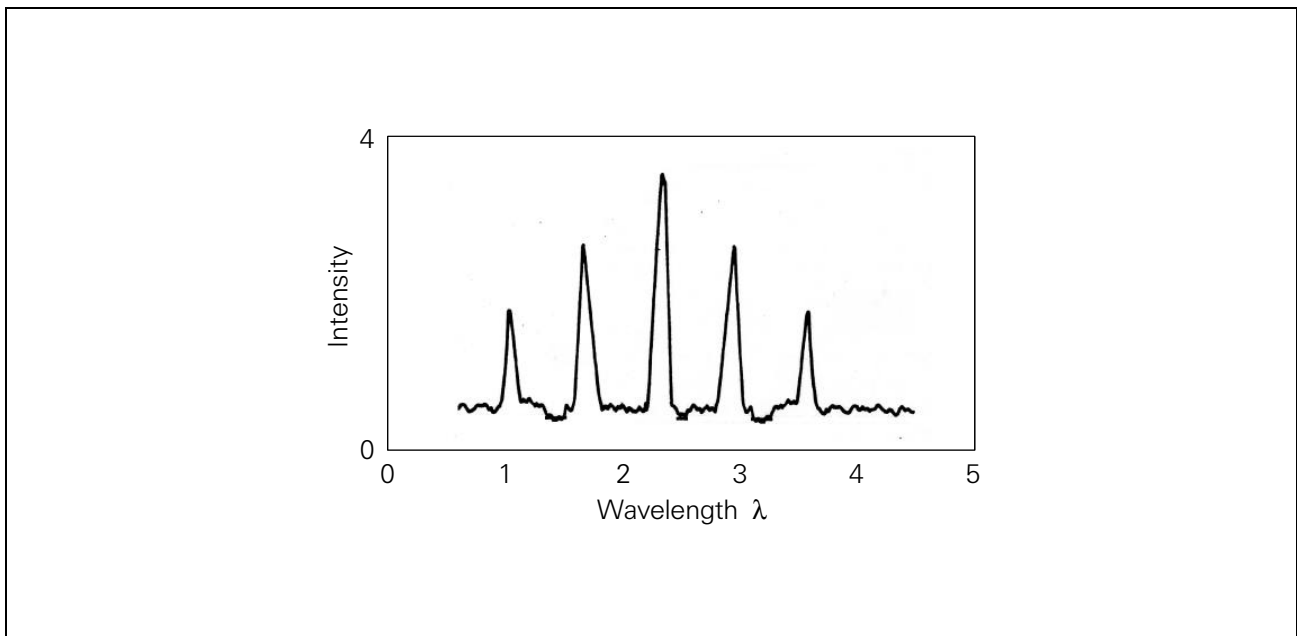
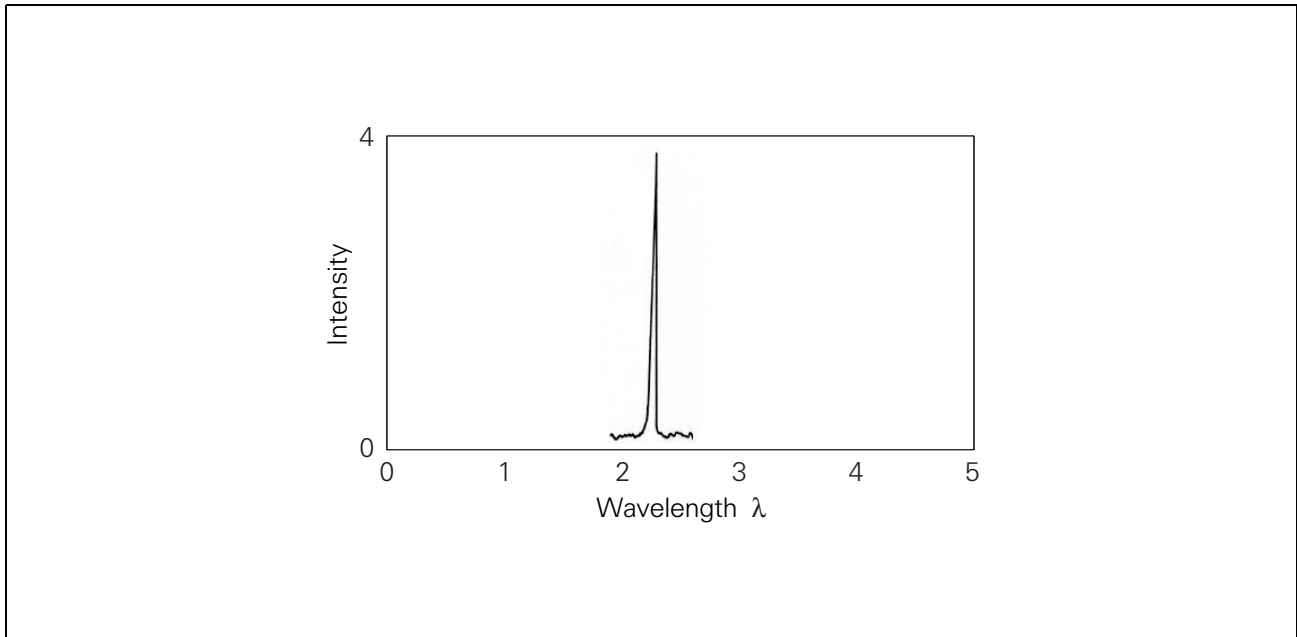

Figure 2 Fabry-Perot Laserdiode



**Figure 3 DFB Laserdiode**

**Regulatory Compliance**

<b>Feature</b>	<b>Standard</b>	<b>Comments</b>
Electrostatic Discharge (ESD) to the Electrical Pins	MIL-STD 883D Method 3015.7	Class 1 (<500 V)

**Technical Data**
**Absolute Maximum Ratings**

Parameter	Symbol	Limit Values		Unit
		min.	max.	
<b>Module</b>				
Operating temperature range at case	$T_C$	-40	85	°C
Storage temperature range	$T_{stg}$	-40	85	
Soldering temperature ( $t_{max} = 10$ s, 2 mm distance from bottom edge of case)	$T_S$		260	

**Laser Diode**

Direct forward current	$I_{F\ max}$		120	mA
Radiant power CW	$P_{F,\ rad}$		2	mW
Reverse Voltage	$V_R$		2	V

**Monitor Diode**

Reverse Voltage	$V_R$		10	V
Forward Current	$I_F$		2	mA

The electro-optical characteristics described in the following tables are only valid for use within the specified maximum ratings or under the recommended operating conditions.

**Transmitter Electro-Optical Characteristics**

Parameter	Symbol	Limit Values			Unit
		min.	typ.	max.	
Optical output power (maximum)	$P_{F,\ max}$	1.2			mW
Emission wavelength center of range, $P_F = 0.5 P_{F,\ max}$ .	$\lambda_{trans}$	1280		1330	nm
Spectral width (RMS)	$\sigma_\lambda$			5	
Temperature coefficient of wavelength	$TC$			0.5	nm/K
Threshold current (whole temperature range)	$I_{th}$	2		45	mA
Forward voltage, $P_F = 0.5 P_{F,\ max}$ .	$V_F$			1.5	V
Radiant power at $I_{th}$	$P_{th}$			40	μW

**Transmitter Electro-Optical Characteristics (cont'd)**

Parameter	Symbol	Limit Values			Unit
		min.	typ.	max.	
Slope efficiency (–40...85°C)	$\eta$	20		100	mW/A
Variation of 1st derivative of P/I (0.1 to 1 mW)	$S_{var}$	–30		30	%
Differential series resistance	$R_S$			8	$\Omega$
Rise time (10%–90%)	$t_r$		100	200	ps
Fall time (10%–90%)	$t_f$		270	500	

**Monitor Diode Electro-Optical Characteristics**

Parameter	Symbol	Limit Values		Unit
		min.	max.	
Dark current, $V_R = 5\text{ V}$ , $P_F = 0$ , $T = T_{max}$	$I_R$		500	nA
Photocurrent, $V_R = 5\text{ V}$ , $P_F = 0.5 P_{F, max}$	$I_P$	100	1000	$\mu\text{A}$
Capacitance, $V_R = 5\text{ V}$ , $f = 1\text{ MHz}$	$C_5$		10	pF
Tracking error <sup>1)</sup> , $V_R = 5\text{ V}$	TE	–1	1	dB

<sup>1)</sup> The tracking error TE is the maximum deviation of  $P_F$  at constant current  $I_{mon}$  over a specified temperature range and relative to the reference point:  $I_{mon, ref} = I_{mon}$  ( $T = 25^\circ\text{C}$ ,  $P_F = 0.5 P_{F, max}$ ). Thus, TE is given by:

$$TE[\text{dB}] = 10 \times \log \frac{P_F[T_C]}{P_F[25^\circ\text{C}]}$$

**End of Life Time Characteristics**

Parameter	Symbol	Limit Values		Unit
		min.	max.	
Threshold current at $T = T_{max}$	$I_{th}$		60	mA
Current above threshold, over full temperature range, at $I_{mon, ref} = I_{mon}$ ( $T = 25^\circ\text{C}$ , $P_F = 0.5 P_{F, max}$ , BOL)	$\Delta I_F$	7	70	
Tracking Error	TE	–1.5	1.5	dB
Monitor Dark Current, $V_R = 2\text{ V}$ , $T = T_{max}$	$I_R$		1	$\mu\text{A}$

**Fiber Data**

The mechanical fiber characteristics are described in the following table.

**Fiber Characteristics**

Parameter	Limit Values			Unit
	min.	typ.	max.	
Mode Field Diameter	8	9	10	μm
Cladding Diameter	123	125	127	
Mode Field/Cladding Concentricity Error			1	
Cladding Non-circularity			2	%
Mode Field Non-circularity			6	
Cut off Wavelength	1270			nm
Jacket Diameter	0.8		1	mm
Bending Radius	30			
Tensile Strength Fiber Case	5			N
Length	0.8		1.2	m

### Eye Safety

Ensure to avoid exposure of human eyes to high power laser diode emitted laser beams. Especially do not look directly into the laser diode or the collimated laser beam when the diode is activated.

#### Class 3B Laser Product According to IEC 60825-1

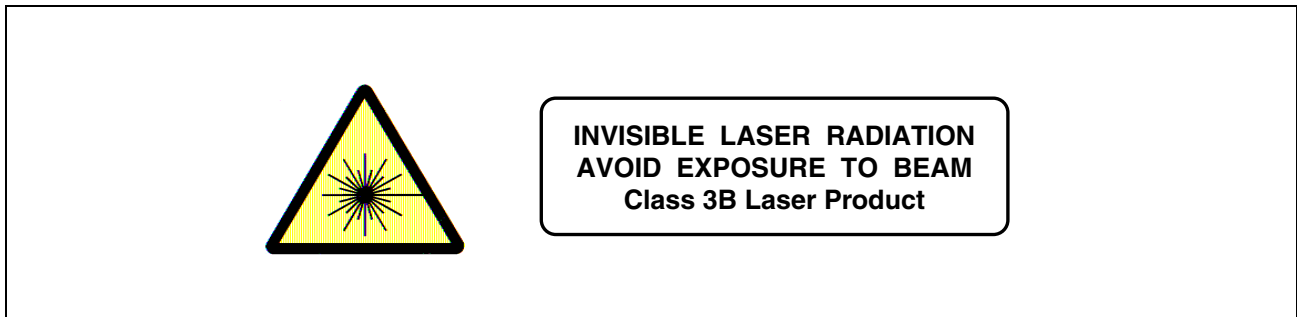

Figure 4 Required Labels

#### Class IIIb Laser Product According to FDA Regulations Complies with 21 CFR 1040.10 and 1040.11



Figure 5 Required Label

### Laser Data

Wavelength	1300 nm
Maximum total output power	less than 50 mW
Beam divergence ( $1/e^2$ )	$10^\circ$



**Package Outlines**

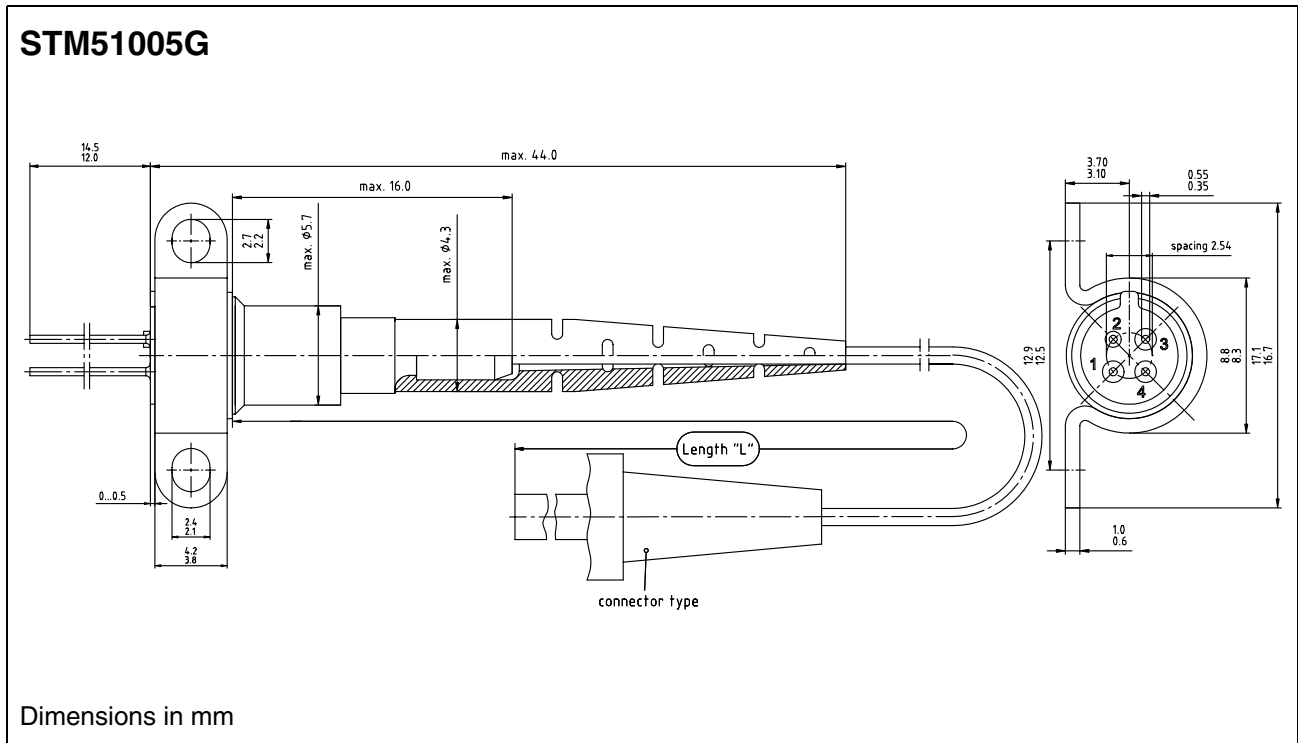

**Figure 6**

**Connector Options**

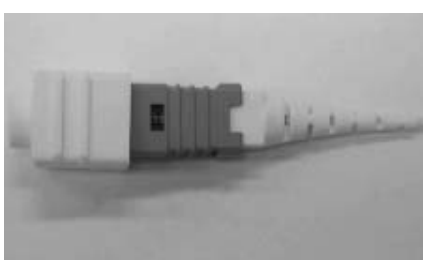
Model	Connector	Type
STM51004G STM51005G		SM FC/PC
STM51004N STM51005N		SM SC/PC 0°
STM51004Z STM51005Z		without connector

---

**STM51004x**

**STM51005x**

**Revision History: 2001-06-01**

DS0

---

Previous Version:

---

<b>Page</b>	<b>Subjects (major changes since last revision)</b>
	Document's layout has been changed: 2002-Aug.

For questions on technology, delivery and prices please contact the Infineon Technologies Offices in Germany or the Infineon Technologies Companies and Representatives worldwide: see our webpage at <http://www.infineon.com>.

**Edition 2001-06-01**

**Published by Infineon Technologies AG,  
St.-Martin-Strasse 53,  
D-81541 München, Germany**

**© Infineon Technologies AG 2002.  
All Rights Reserved.**

#### **Attention please!**

The information herein is given to describe certain components and shall not be considered as warranted characteristics.

Terms of delivery and rights to technical change reserved.

We hereby disclaim any and all warranties, including but not limited to warranties of non-infringement, regarding circuits, descriptions and charts stated herein.

Infineon Technologies is an approved CECC manufacturer.

#### **Information**

For further information on technology, delivery terms and conditions and prices please contact your nearest Infineon Technologies Office in Germany or our Infineon Technologies Representatives worldwide.

#### **Warnings**

Due to technical requirements components may contain dangerous substances. For information on the types in question please contact your nearest Infineon Technologies Office.

Infineon Technologies Components may only be used in life-support devices or systems with the express written approval of Infineon Technologies, if a failure of such components can reasonably be expected to cause the failure of that life-support device or system, or to affect the safety or effectiveness of that device or system. Life-support devices or systems are intended to be implanted in the human body, or to support and/or maintain and sustain and/or protect human life. If they fail, it is reasonable to assume that the health of the user or other persons may be endangered.