

LDMOS RF Power Field Effect Transistor 90 W, 869–960 MHz

Description

The PTF080901 is a 90 W, internally matched *GOLDMOS* FET intended for EDGE and CDMA applications in the 860 to 960 MHz band. Full gold metallization ensures excellent device lifetime and reliability.

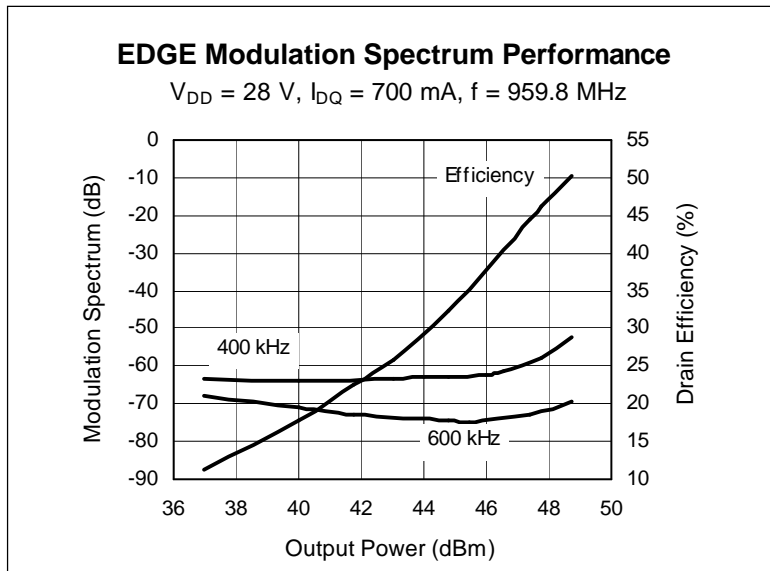

Features

- Broadband internal matching
- Typical EDGE performance
 - Average output power = 45 W
 - Gain = 18 dB
 - Efficiency = 40%
- Typical CW performance
 - Output power at P-1dB = 120 W
 - Gain = 17 dB
 - Efficiency = 60%
- Integrated ESD protection: Human Body Model, Class 1 (minimum)
- Excellent thermal stability
- Low HCI drift
- Capable of handling 10:1 VSWR @ 28 V, 90 W (CW) output power

PTF080901E
Package 30248



PTF080901F
Package 31248

ESD: Electrostatic discharge sensitive device—observe handling precautions!

RF Characteristics at $T_{CASE} = 25^\circ\text{C}$ unless otherwise indicated

EDGE Measurements (not subject to production test—verified by design/characterization in Infineon test fixture)

$V_{DD} = 28\text{ V}$, $I_{DQ} = 700\text{ mA}$, $P_{OUT} = 45\text{ W}$, $f = 959.8\text{ MHz}$

Characteristic	Symbol	Min	Typ	Max	Unit
Error Vector Magnitude	EVM (RMS)	—	2.5	—	%
Modulation Spectrum @ 400 kHz	ACPR	—	-62	—	dBc
Modulation Spectrum @ 600 kHz	ACPR	—	-74	—	dBc
Gain	G_{ps}	—	18	—	dB
Drain Efficiency	η_D	—	40	—	%

Two-Tone Measurements (tested in Infineon test fixture)

$V_{DD} = 28\text{ V}$, $I_{DQ} = 650\text{ mA}$, $P_{OUT} = 90\text{ W PEP}$, $f = 960\text{ MHz}$, tone spacing = 1 MHz

Characteristic	Symbol	Min	Typ	Max	Unit
Gain	G_{ps}	17	18	—	dB
Drain Efficiency	η_D	40	42	—	%
Intermodulation Distortion	IMD	—	-32	-29	dBc

DC Characteristics at $T_{CASE} = 25^{\circ}C$ unless otherwise indicated

Characteristic	Conditions	Symbol	Min	Typ	Max	Unit
Drain–Source Breakdown Voltage	$V_{GS} = 0 V, I_{DS} = 10 \mu A$	$V_{(BR)DSS}$	65	—	—	V
Drain Leakage Current	$V_{DS} = 28 V, V_{GS} = 0 V$	I_{DSS}	—	—	1.0	μA
On–State Resistance	$V_{GS} = 10 V, V_{DS} = 0.1 V$	$R_{DS(on)}$	—	0.1	—	Ω
Operating Gate Voltage	$V_{DS} = 28 V, I_{DQ} = 650 mA$	V_{GS}	2.5	3.2	4	V
Gate Leakage Current	$V_{GS} = 10 V, V_{DS} = 0 V$	I_{GSS}	—	—	1.0	μA

Maximum Ratings

Parameter	Symbol	Value	Unit
Drain–Source Voltage	V_{DSS}	65	V
Gate–Source Voltage	V_{GS}	-0.5 to +12	V
Junction Temperature	T_J	200	$^{\circ}C$
Total Device Dissipation Above 25 $^{\circ}C$ derate by	P_D	335 1.9	W W/ $^{\circ}C$
Storage Temperature Range	T_{STG}	-40 to +150	$^{\circ}C$
Thermal Resistance ($T_{CASE} = 70^{\circ}C$)	$R_{\theta JC}$	0.52	$^{\circ}C/W$

Typical Performance (measurements taken in production test fixture)

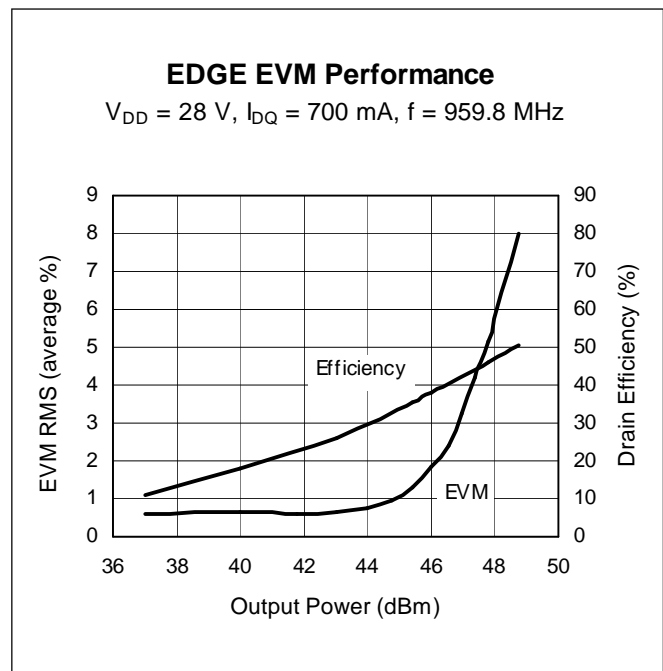
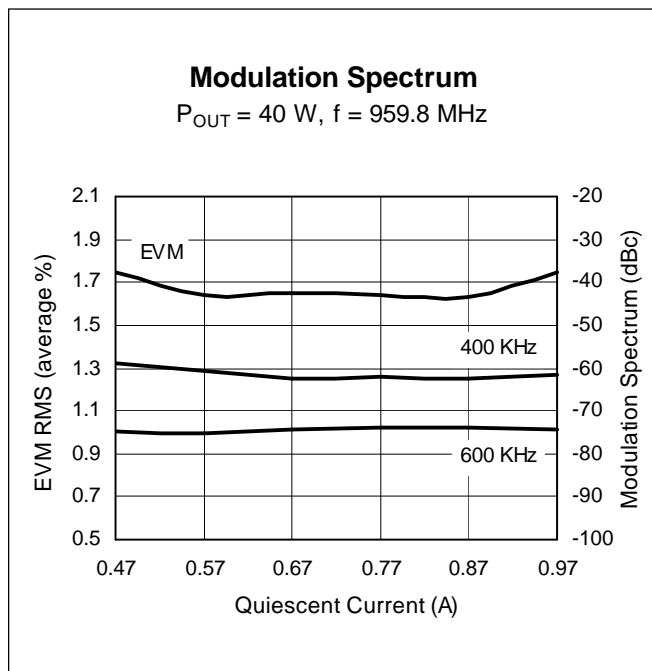

All published data at $T_{CASE} = 25^{\circ}C$ unless otherwise indicated.

Typical Performance (cont.)

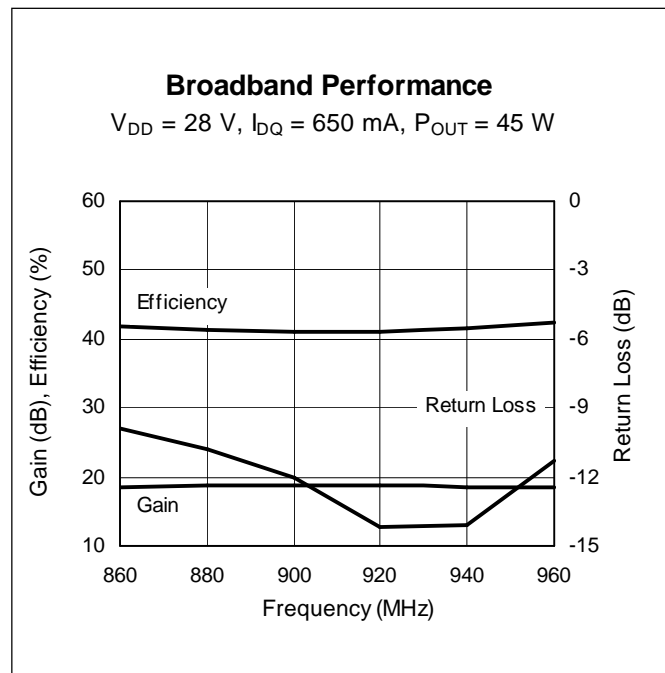
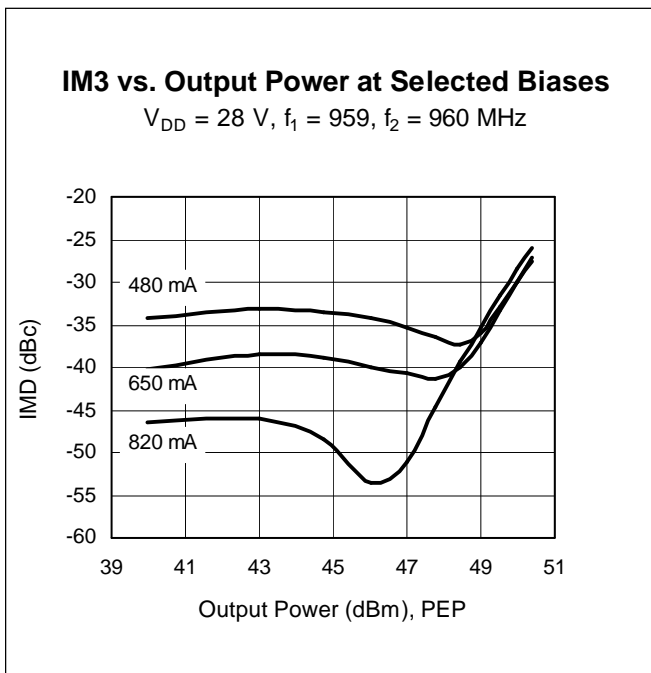
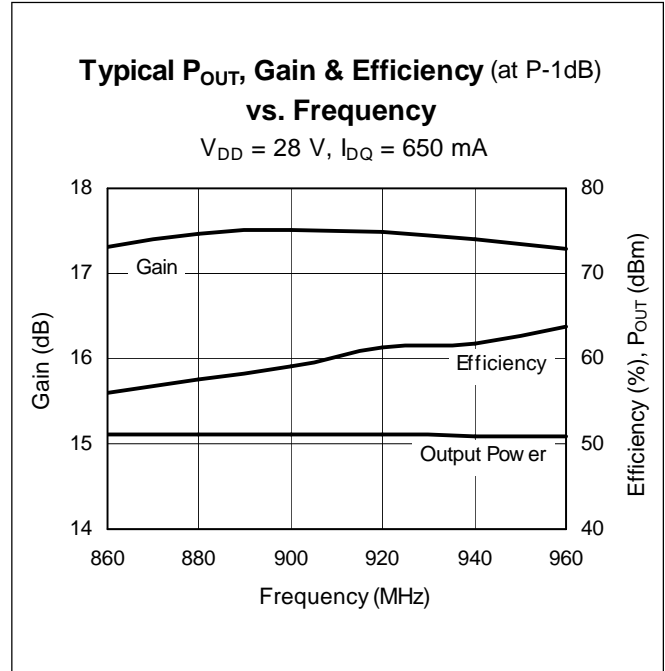
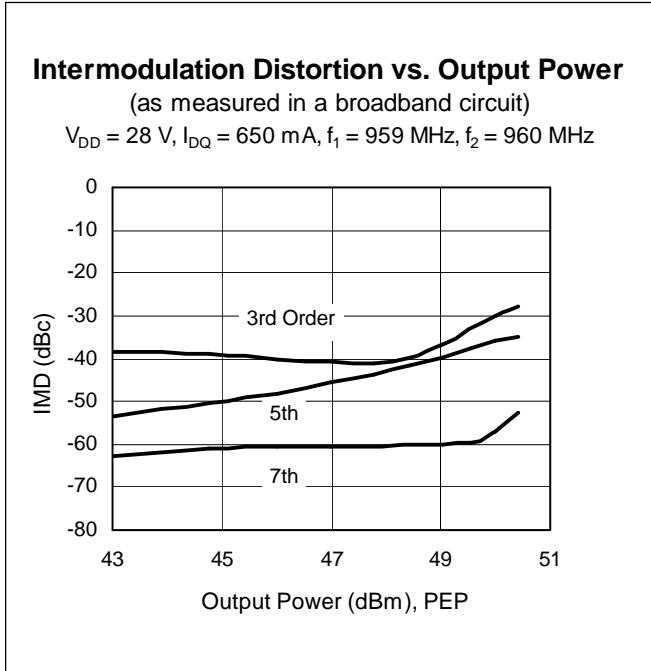

All published data at $T_{CASE} = 25^\circ\text{C}$ unless otherwise indicated.

Typical Performance (cont.)

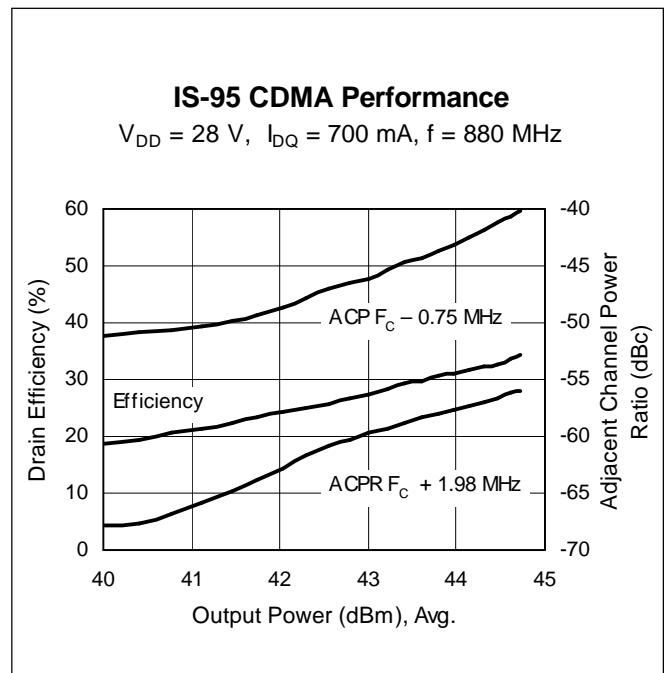
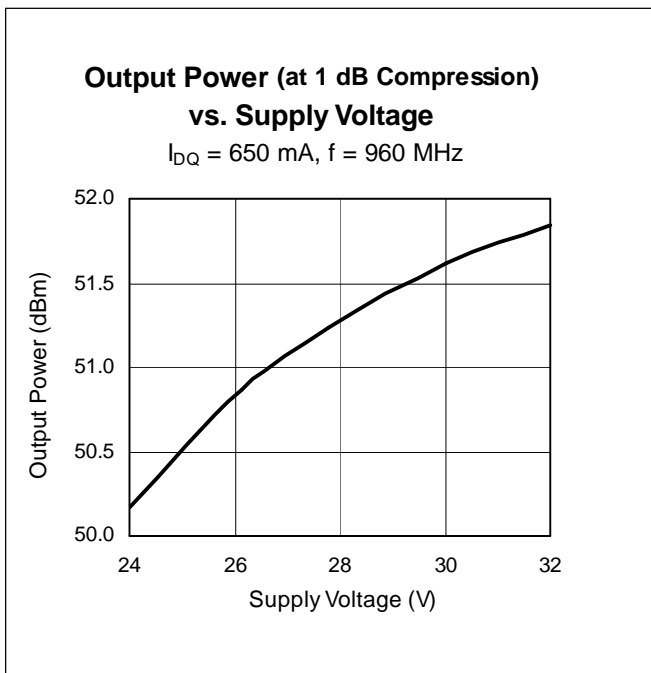
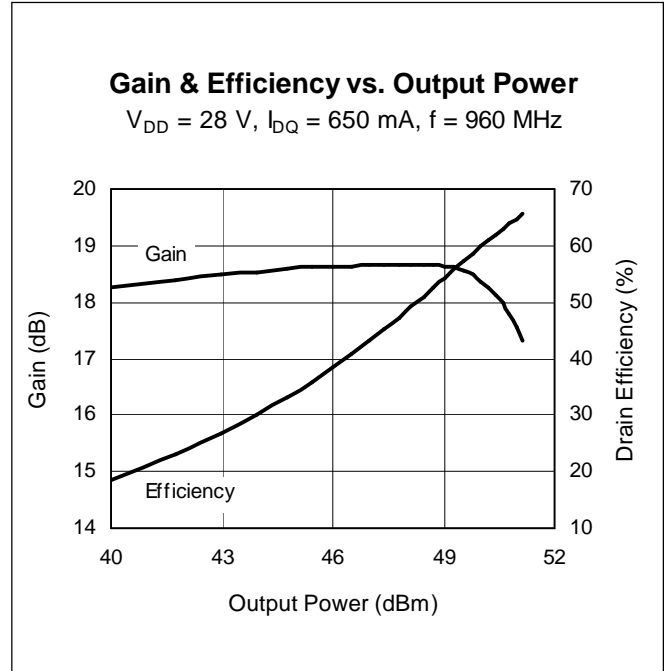
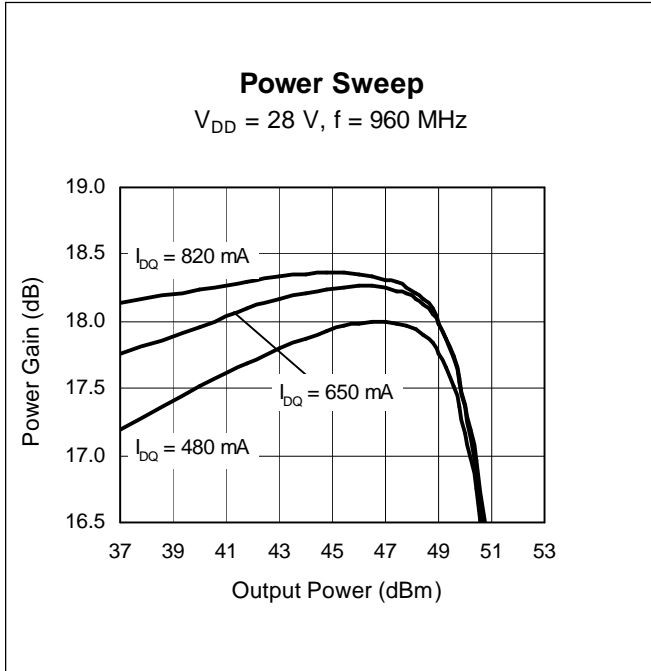

All published data at $T_{CASE} = 25^\circ\text{C}$ unless otherwise indicated.

Typical Performance (cont.)

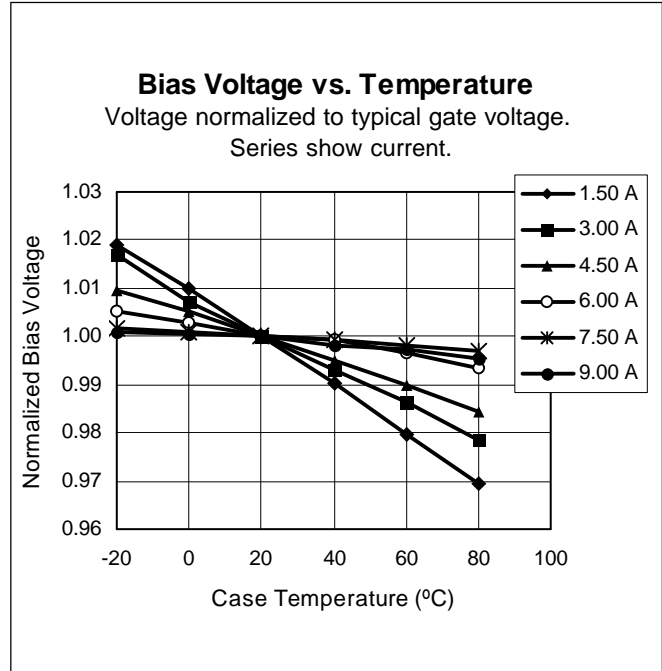
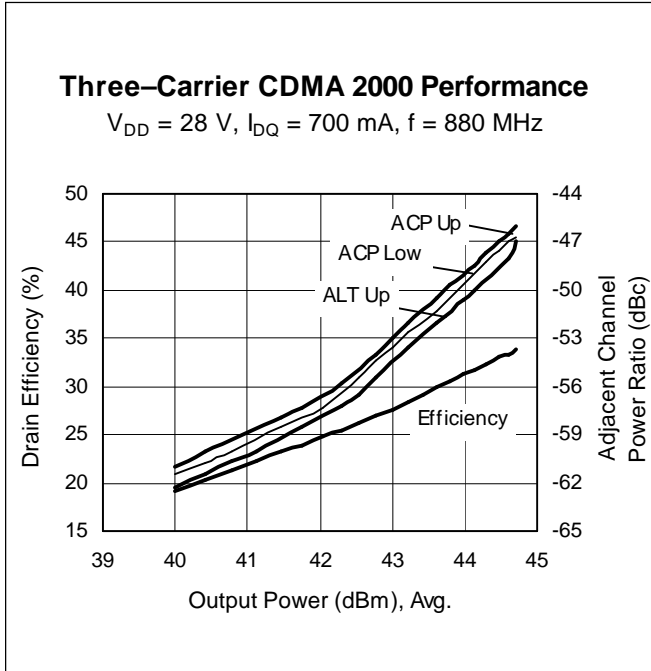

Broadband Circuit Impedance

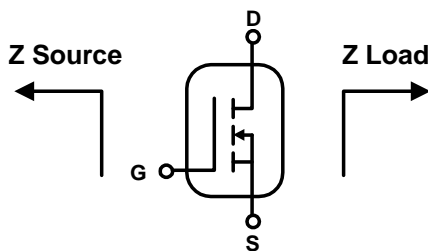

Frequency MHz	Z Source Ω		Z Load Ω	
	R	jX	R	jX
860	2.50	-1.09	1.98	-1.08
920	2.67	-0.43	1.99	-0.32
940	2.79	-0.35	1.87	-0.21
960	2.94	0.12	1.85	0.27
980	2.91	0.37	1.79	0.53

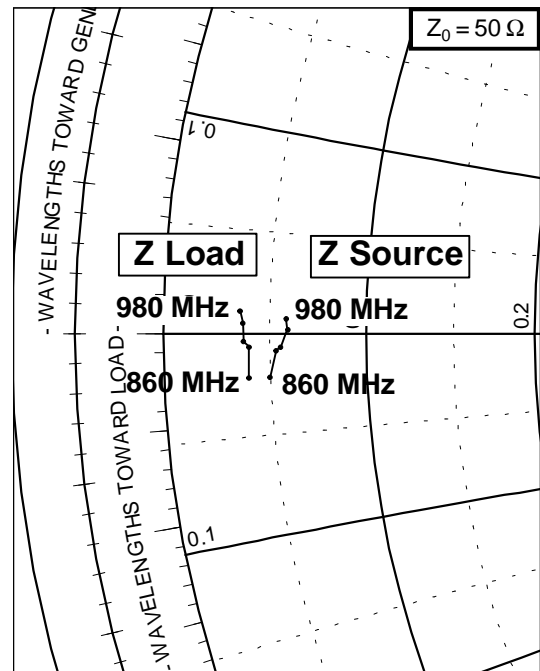

All published data at $T_{CASE} = 25^\circ\text{C}$ unless otherwise indicated.

Test Circuit

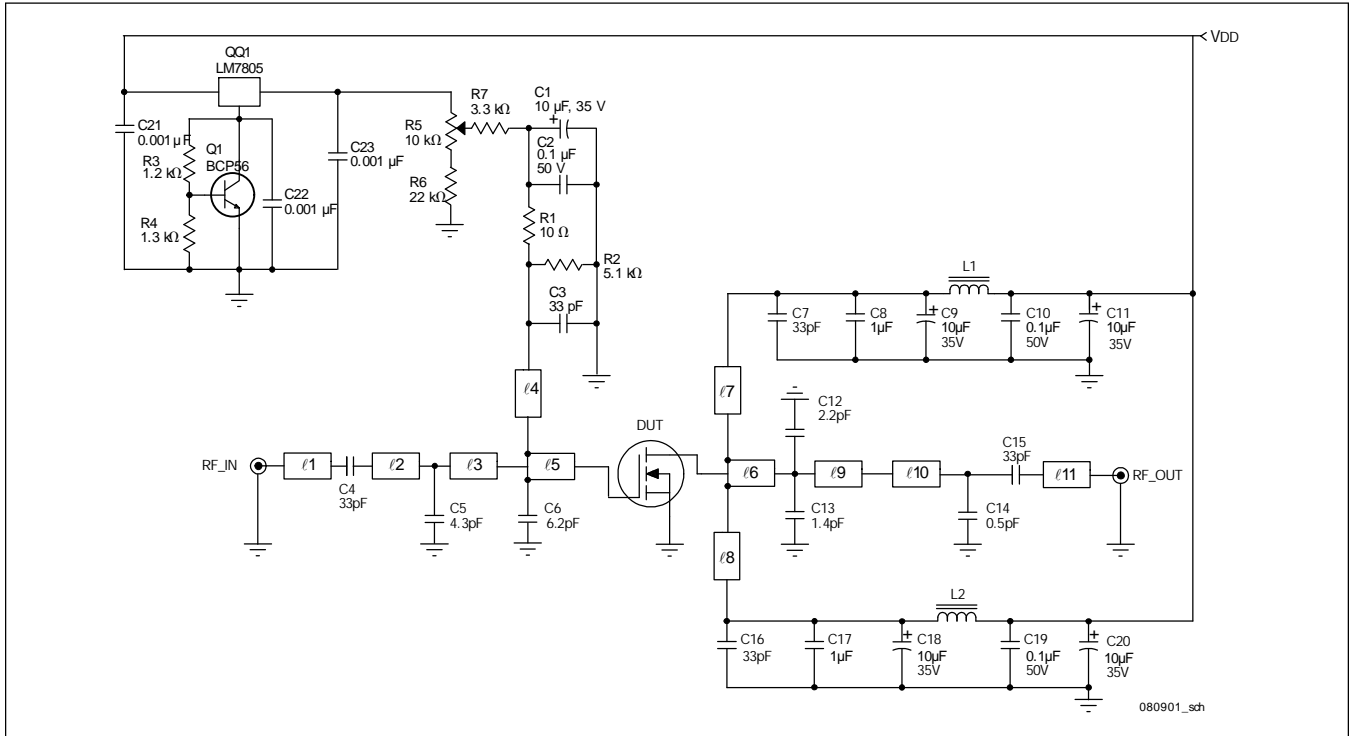

Test Circuit Schematic for 960 MHz

Circuit Assembly Information

DUT	PTF080901	LDMOS Transistor	
PCB	0.76 mm. [.030"] thick, $\epsilon_r = 4.5$	2 oz. copper	Rogers TMM4

Microstrip	Electrical Characteristics at 960 MHz	Dimensions: L x W (mm.)	Dimensions: L x W (in.)
$\ell 1$	0.075λ , 50 Ω	12.83 x 1.35	0.505 x 0.053
$\ell 2$	0.101λ , 50 Ω	17.27 x 1.35	0.680 x 0.053
$\ell 3$	0.053λ , 50 Ω	9.14 x 1.35	0.360 x 0.053
$\ell 4$	0.289λ , 73.66 Ω	50.80 x 0.75	2.000 x 0.030
$\ell 5$	0.061λ , 7.48 Ω	9.27 x 16.26	0.365 x 0.640
$\ell 6$	0.097λ , 7.93 Ω	14.73 x 15.24	0.580 x 0.600
$\ell 7, \ell 8$	0.132λ , 52.47 Ω	22.61 x 1.27	0.890 x 0.050
$\ell 9$	0.105λ , 7.93 Ω	16.13 x 15.24	0.635 x 0.600
$\ell 10$	0.134λ , 38.02 Ω	22.35 x 2.16	0.880 x 0.085
$\ell 11$	0.029λ , 50 Ω	4.95 x 1.37	0.195 x 0.053

Test Circuit (cont.)

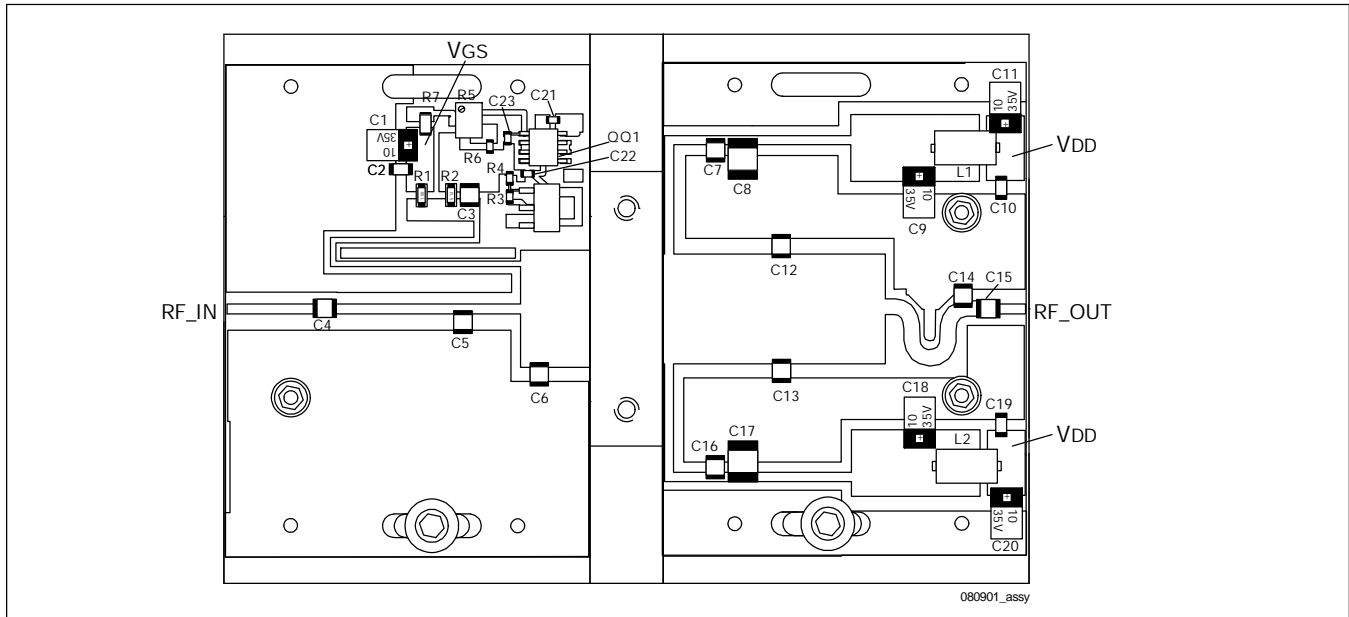

Reference Circuit¹ (not to scale)

Component	Description	Manufacturer	P/N or Comment
C1, C9, C11, C18, C20	Capacitor, 10 μ F, 35 V	Digi-Key	Tantalum TE Series SMD PCS6106TR-ND
C2, C10, C19	Capacitor, 0.1 μ F, 50 V	Digi-Key	P4525-ND
C3, C4, C7, C15, C16	Capacitor, 33 pF	ATC	100B 330
C5	Capacitor, 4.3 pF	ATC	100B 4R3
C6	Capacitor, 6.2 pF	ATC	100B 6R2
C8, C17	Capacitor, 1 μ , 50 V	Digi-Key	19528-ND
C12	Capacitor, 2.2 pF	ATC	100B 2R2
C13	Capacitor, 1.4 pF	ATC	100B 1R4
C14	Capacitor, 0.5 pF	ATC	100B 0R5
C21, C22, C23	Capacitor, 0.001 μ F, 50 V, 0603	Digi-Key	PCC1772CT-ND
L1, L2	Ferrite, 6 mm	Philips	53/3/4.6-452
Q1	Transistor	Infineon	BCP56
QQ1	Voltage Regulator	National Semiconductor	LM7805
R1	Resistor, 10 ohms, 1/4 W, 1206	Digi-Key	P10ECT-ND
R2	Resistor, 5.1 k-ohms, 1/4 W, 1206	Digi-Key	P5.1KECT-ND
R3	Resistor, 1.2 k-ohms, 1/10 W, 0603	Digi-Key	P1.2KGCT-ND
R4	Resistor, 1.3 k-ohms, 1/10 W, 0603	Digi-Key	P1.3KGCT-ND
R5	Resistor, Variable, 10 k-ohms, 1/4 W	Digi-Key	3224W-103ETR-ND
R6	Resistor, 22 k-ohms, 1/10 W, 0603	Digi-Key	P22KGCT-ND
R7	Resistor, 3.3 k-ohms, 1/4 W, 1206	Digi-Key	P3.3KECT-ND

¹Gerber files for this circuit are available on request.

Ordering Information

Type	Package Outline	Package Description	Marking
PTF080901E	30248	Thermally enhanced, flange mount	PTF080901E
PTF080901F	31248	Thermally enhanced, earless	PTF080901F

Package Outline Specifications

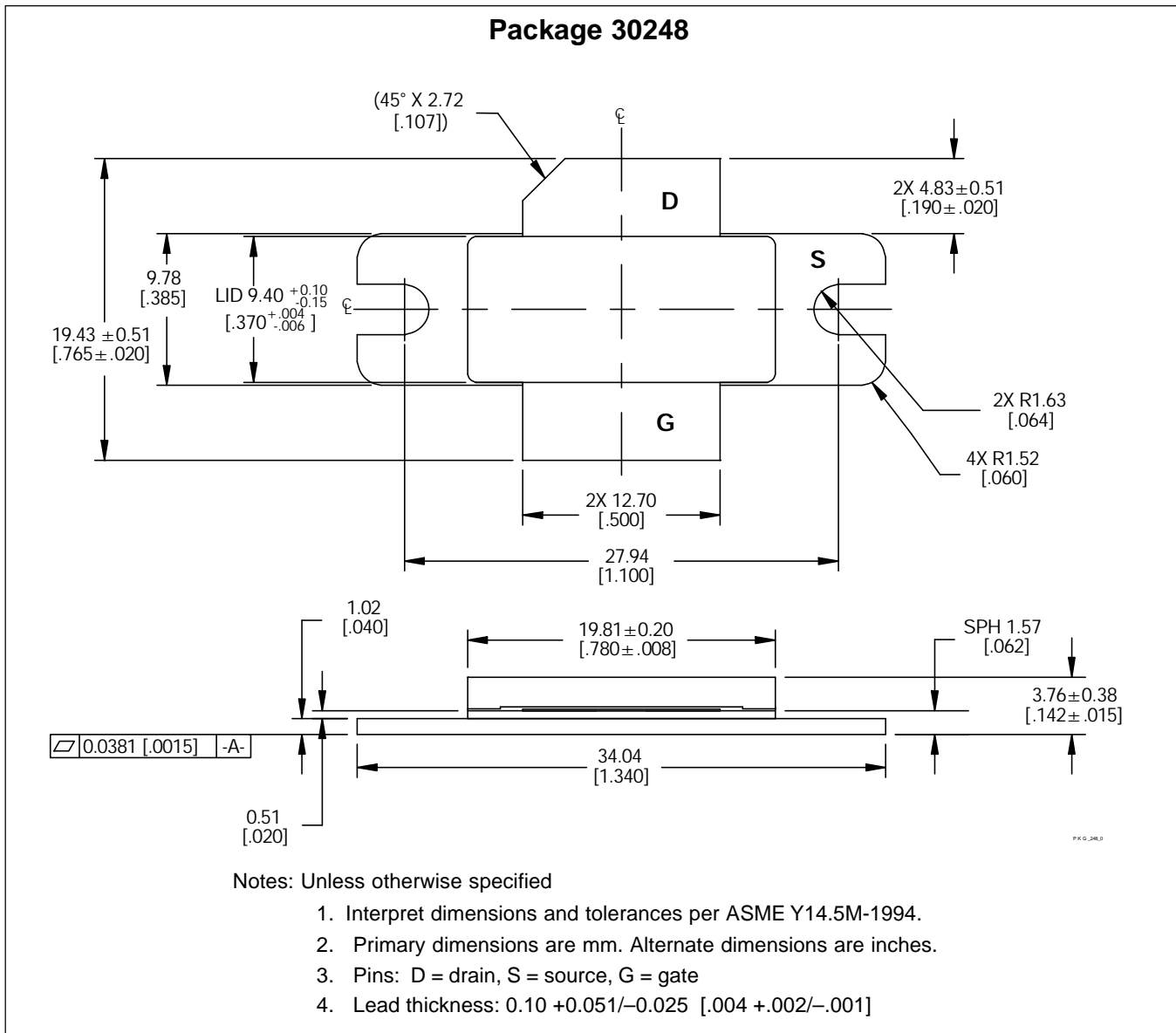

Find the latest and most complete information about products and packaging at the Infineon Internet page <http://www.infineon.com/products>

Package Outline Specifications

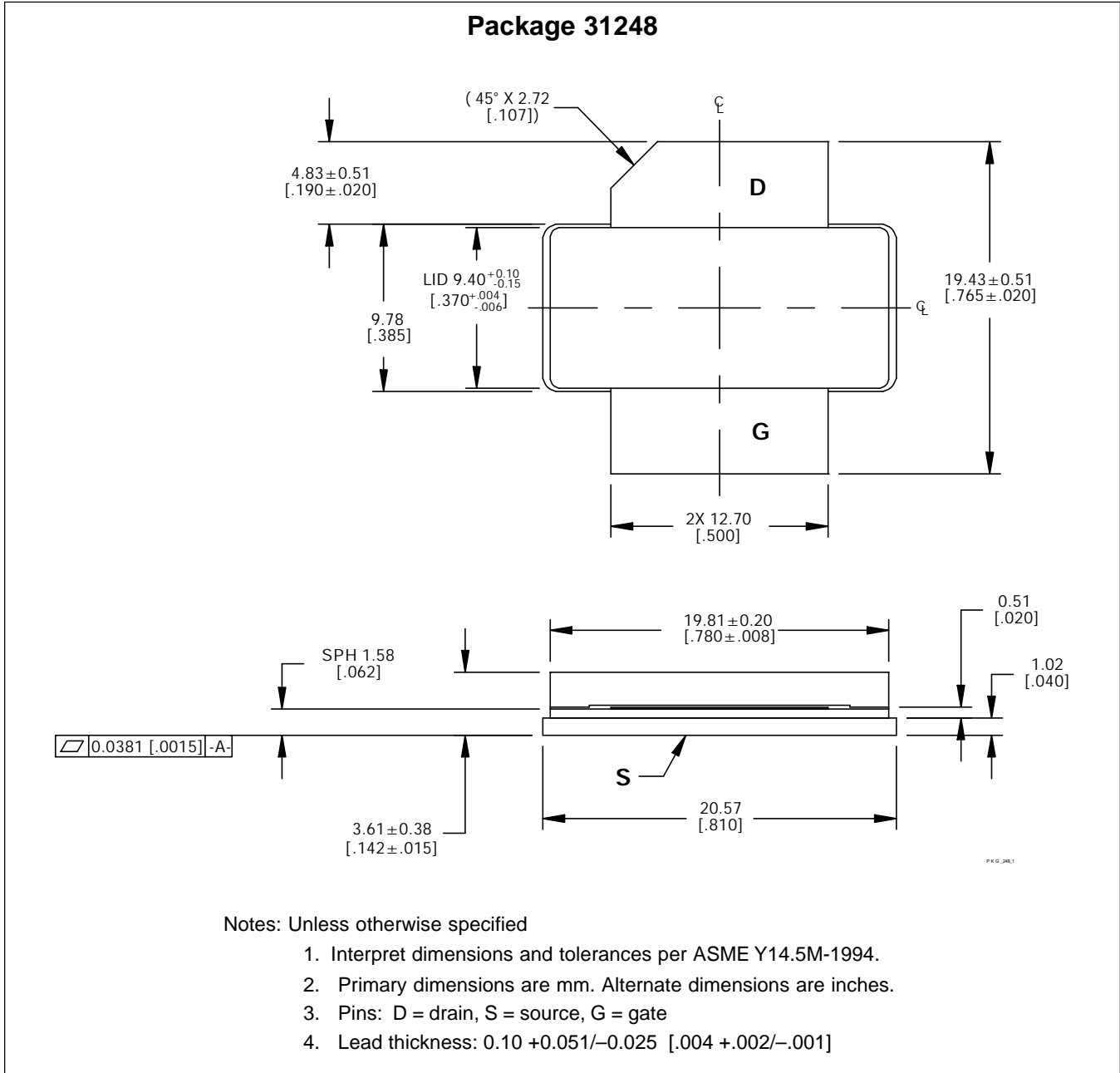

Find the latest and most complete information about products and packaging at the Infineon Internet page
<http://www.infineon.com/rfpower>

Page	Subjects (major changes since last revision)
1,8,9	Add information about PTF080901F, new package outline diagrams
6,7	Circuit information updated.

We Listen to Your Comments

Any information within this document that you feel is wrong, unclear or missing at all?
Your feedback will help us to continuously improve the quality of this document.
Please send your proposal (including a reference to this document) to:

highpowerRF@infineon.com

To request other information, contact us at:
+1 877 465 3667 (1-877-GOLDMOS) USA
or +1 408 776 0600 International

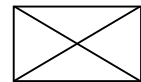

GOLDMOS® is a registered trademark of Infineon Technologies AG.

Edition 2004-04-05

Published by Infineon Technologies AG,
St.-Martin-Strasse 53,
81669 München, Germany

© Infineon Technologies AG 2003.
All Rights Reserved.

Attention please!

The information herein is given to describe certain components and shall not be considered as a guarantee of characteristics.

Terms of delivery and rights to technical change reserved.

We hereby disclaim any and all warranties, including but not limited to warranties of non-infringement, regarding circuits, descriptions and charts stated herein.

Information

For further information on technology, delivery terms and conditions and prices please contact your nearest Infineon Technologies Office (www.infineon.com/rfpower).

Warnings

Due to technical requirements components may contain dangerous substances. For information on the types in question please contact your nearest Infineon Technologies Office.

Infineon Technologies Components may only be used in life-support devices or systems with the express written approval of Infineon Technologies, if a failure of such components can reasonably be expected to cause the failure of that life-support device or system, or to affect the safety or effectiveness of that device or system. Life support devices or systems are intended to be implanted in the human body, or to support and/or maintain and sustain and/or protect human life. If they fail, it is reasonable to assume that the health of the user or other persons may be endangered.